

US00D508688S

(12) **United States Design Patent** (10) **Patent No.:** **US D508,688 S**  
**Lee et al.** (45) **Date of Patent:** **\*\* Aug. 23, 2005**

(54) **PORTABLE TELEPHONE**

(75) Inventors: **Kee-Moon Lee**, Gyeongsangbuk-Do (KR); **Chang-Hwan Hwang**, Goyang-Si (KR); **Hyun-Seop Kim**, Gunpo-Si (KR)

(73) Assignee: **Samsung Electronics Co., Ltd.**, Suwon (KR)

(\*\*) Term: **14 Years**

(21) Appl. No.: **29/210,519**

(22) Filed: **Aug. 3, 2004**

(30) **Foreign Application Priority Data**

May 6, 2004 (KR) ..... 2004-0012988

(51) **LOC (8) Cl.** ..... **14-03**

(52) **U.S. Cl.** ..... **D14/138**

(58) **Field of Search** ..... D14/137, 138, D14/147-148, 247-248, 144, 341-347; 379/433.01-433.13, 434; 455/550.1-90.3, 575.4, 566, 575.1, 556.1, 556.2, 575.6; D21/517; 345/169

(56) **References Cited**

**U.S. PATENT DOCUMENTS**

D423,493 S	*	4/2000	Hakoda	.....	D14/138
D425,887 S	*	5/2000	Edwards et al.	.....	D14/138
D432,511 S	*	10/2000	Eckholm	.....	D14/138
D465,219 S	*	11/2002	Tamaki et al.	.....	D14/346
D466,096 S	*	11/2002	Takada	.....	D14/138
D476,328 S	*	6/2003	Miao et al.	.....	D14/346
D479,215 S	*	9/2003	Yokoyama	.....	D14/138
D481,692 S	*	11/2003	Husgafvel	.....	D14/138
D484,503 S	*	12/2003	Duarte et al.	.....	D14/346
D488,789 S	*	4/2004	Lee	.....	D14/138
D493,156 S	*	7/2004	Hamann et al.	.....	D14/138
D495,310 S	*	8/2004	Husgafvel	.....	D14/138
D495,695 S	*	9/2004	Yugaya	.....	D14/346
D496,921 S	*	10/2004	Hwang	.....	D14/138
D498,736 S	*	11/2004	Lee	.....	D14/138
6,822,871 B2	*	11/2004	Lee et al.	.....	361/727
D500,992 S	*	1/2005	Shen et al.	.....	D14/138
D501,475 S	*	2/2005	Kim	.....	D14/346

D502,162 S	*	2/2005	Kim et al.	.....	D14/138
D502,454 S	*	3/2005	Lee	.....	D14/138
2001/0036266 A1	*	11/2001	Gronroos et al.	.....	379/433.01
2003/0064688 A1	*	4/2003	Mizuta et al.	.....	455/90
2004/0198458 A1	*	10/2004	Kawamura	.....	455/566
2004/0259592 A1	*	12/2004	Taneya et al.	.....	455/556.1
2004/0266477 A1	*	12/2004	Murata	.....	455/556.1
2005/0009581 A1	*	1/2005	Im et al.	.....	455/575.4
2005/0014527 A1	*	1/2005	Chambers et al.	.....	455/556.1
2005/0014538 A1	*	1/2005	Hyun et al.	.....	455/575.4
2005/0020327 A1	*	1/2005	Chung et al.	.....	455/575.3

**FOREIGN PATENT DOCUMENTS**

JP	1088577	*	10/2000	
JP	1120255	*	9/2001	
JP	1160810	*	12/2002	
JP	2003298699 A	*	10/2003	..... H04M/1/02

**OTHER PUBLICATIONS**

NTTDoCoMo SO505i, © 2003, showings from NTT DoCoMo visited Apr. 10, 2003 and www.mobileburn.com visited Sep. 28, 2004.\*  
www.mobiletechnews.com visited Mar. 3, 2005, Samsung SGH-D500 phone, article posted Oct. 11, 2004.\*

\* cited by examiner

*Primary Examiner*—Jeffrey Asch

(74) *Attorney, Agent, or Firm*—Leydig, Voit & Mayer, Ltd.

(57) **CLAIM**

We claim the ornamental design for a portable telephone, as shown and described.

**DESCRIPTION**

FIG. 1 is a perspective view of a portable telephone, when closed, according to our new design;  
FIG. 2 is a front view thereof, when closed;  
FIG. 3 is a rear view thereof, when closed;  
FIG. 4 is a left side view thereof, when closed;  
FIG. 5 is a right side view thereof, when closed;  
FIG. 6 is a top view thereof, when closed;  
FIG. 7 is a bottom view thereof, when closed;  
FIG. 8 is a front view thereof, when open; and,  
FIG. 9 is a rear view thereof, when open.

**1 Claim, 6 Drawing Sheets**

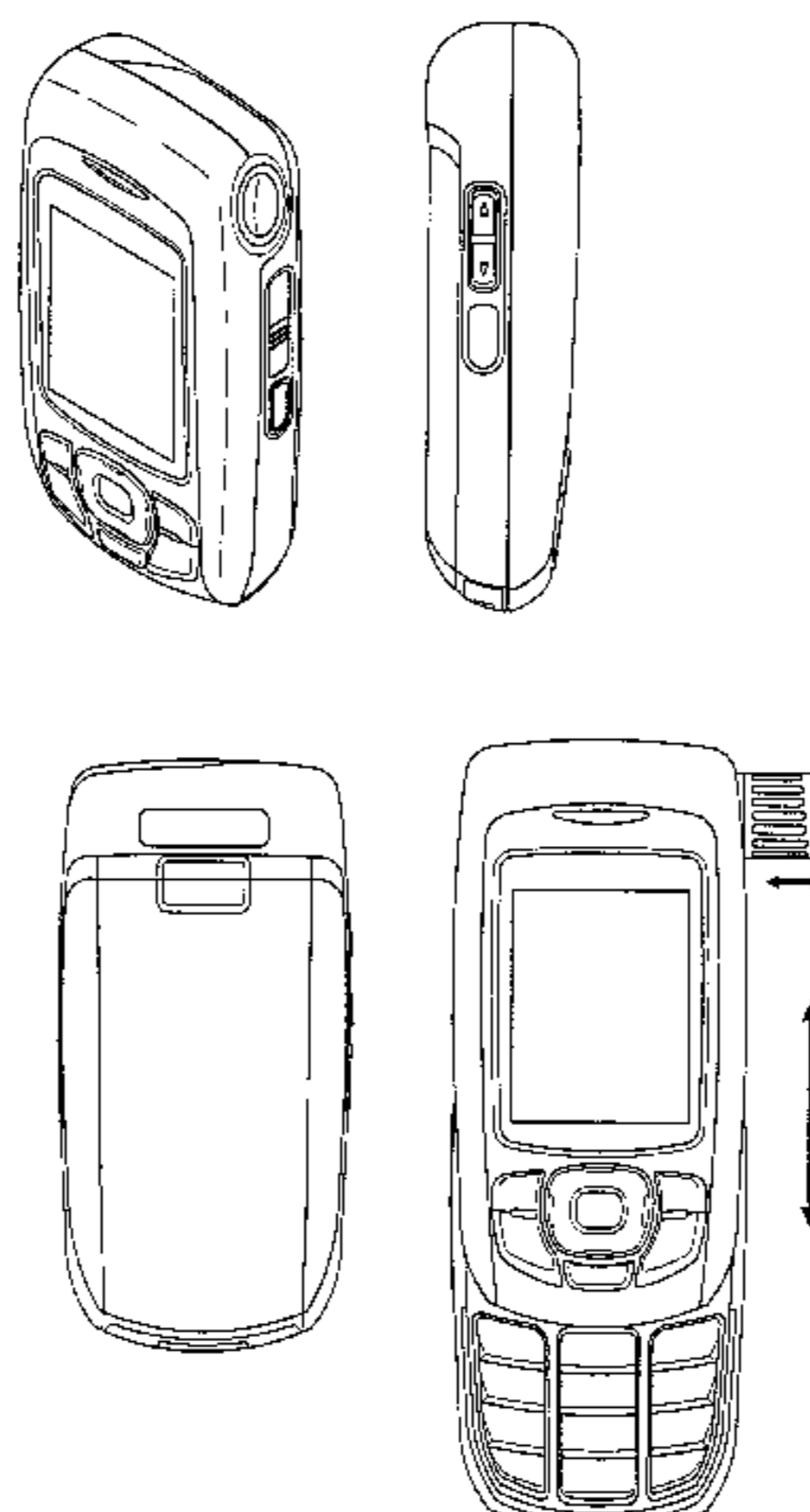

Fig. 1

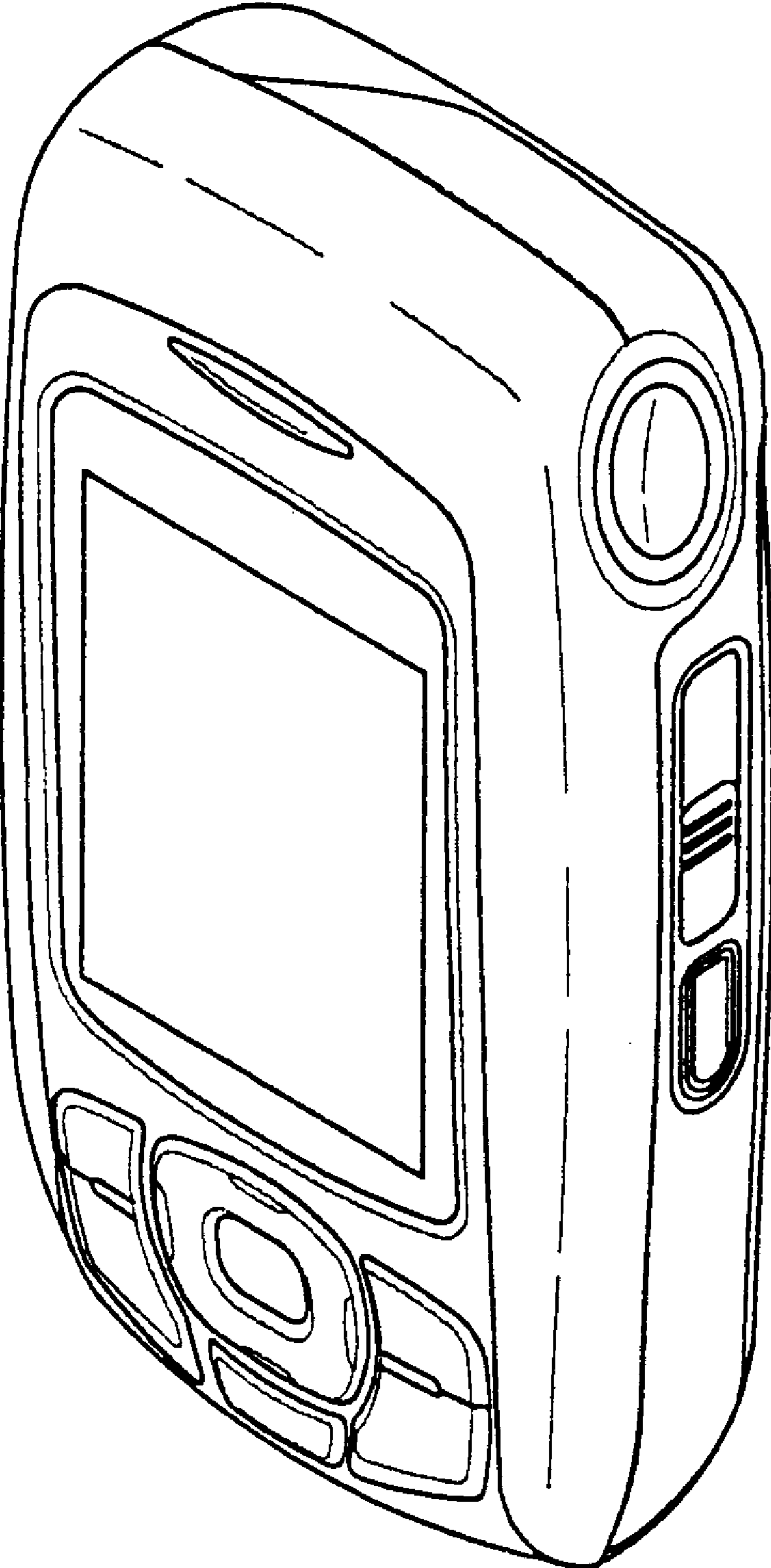

Fig. 2

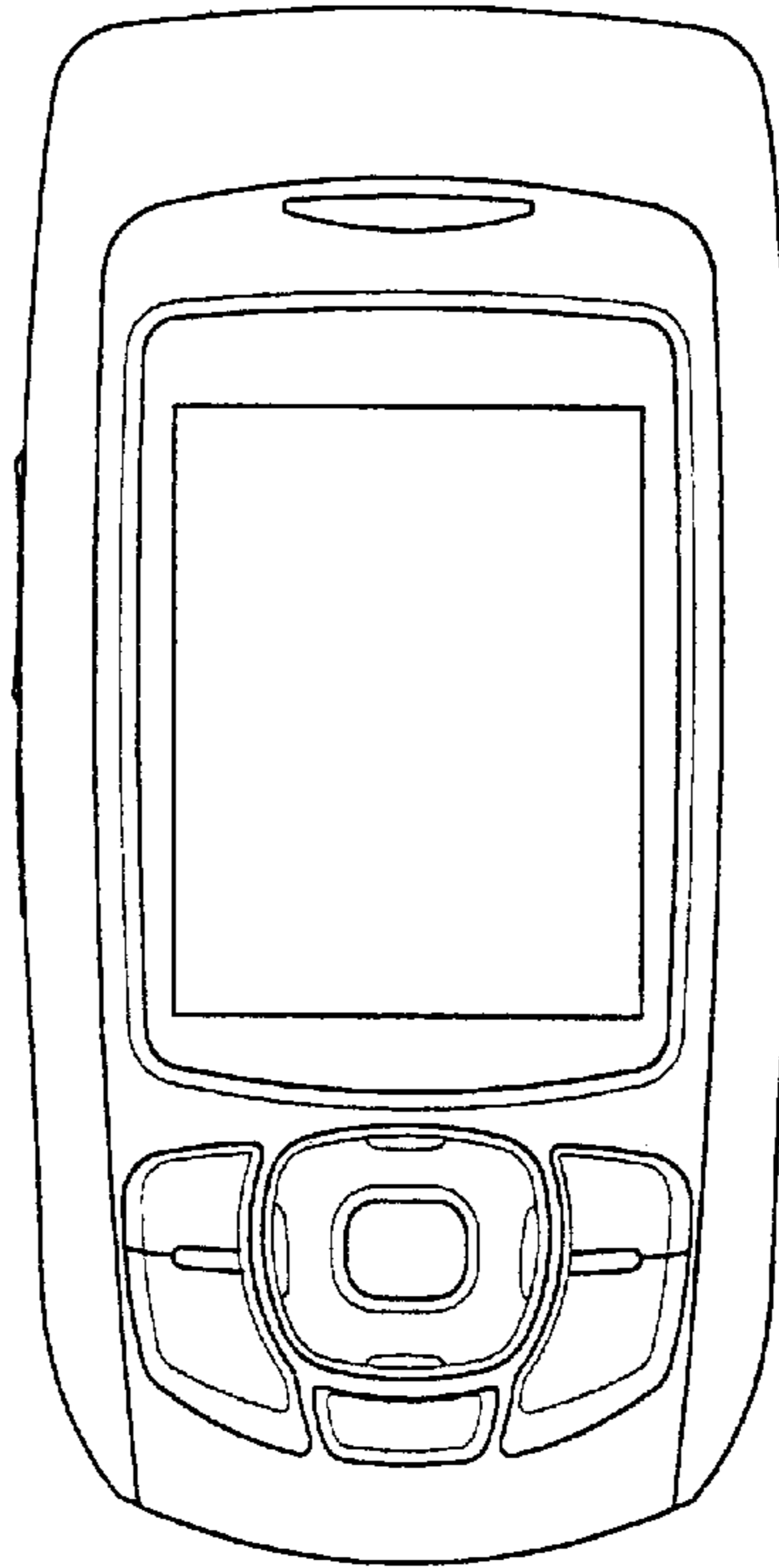

Fig. 3

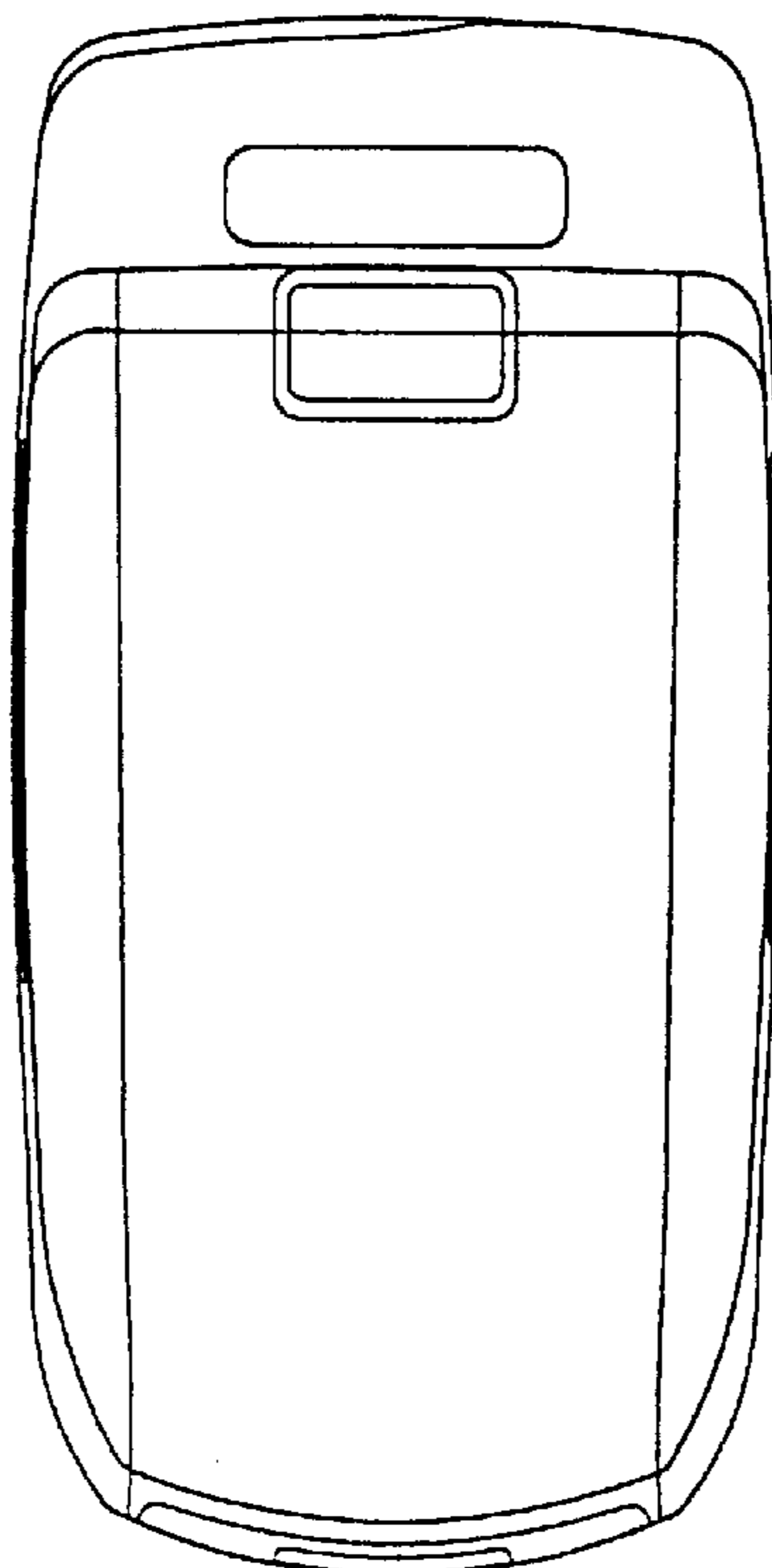

Fig. 4

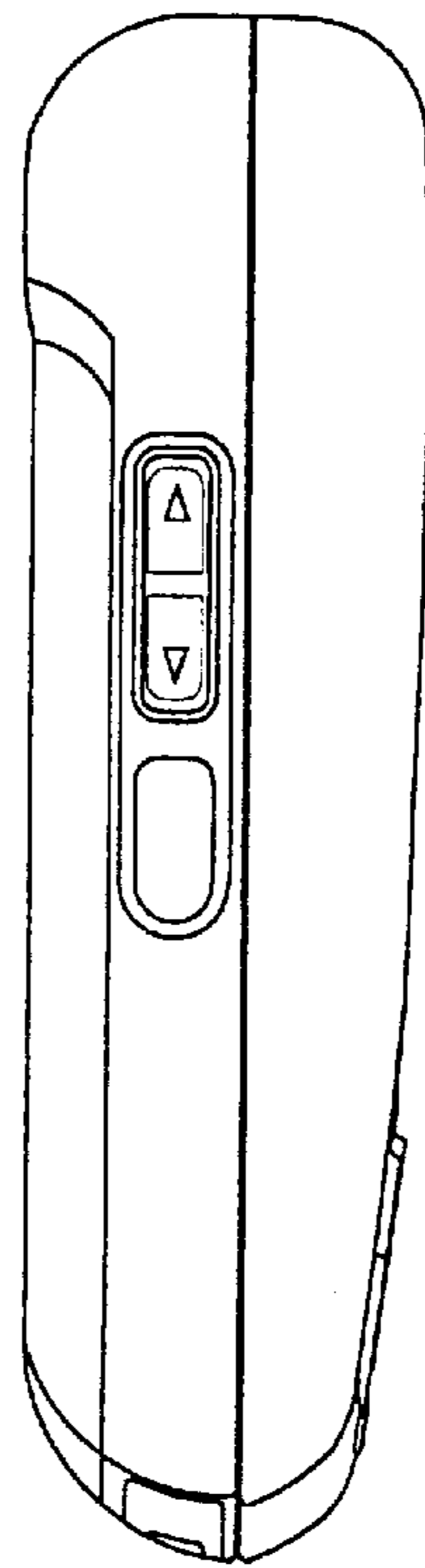

Fig. 5

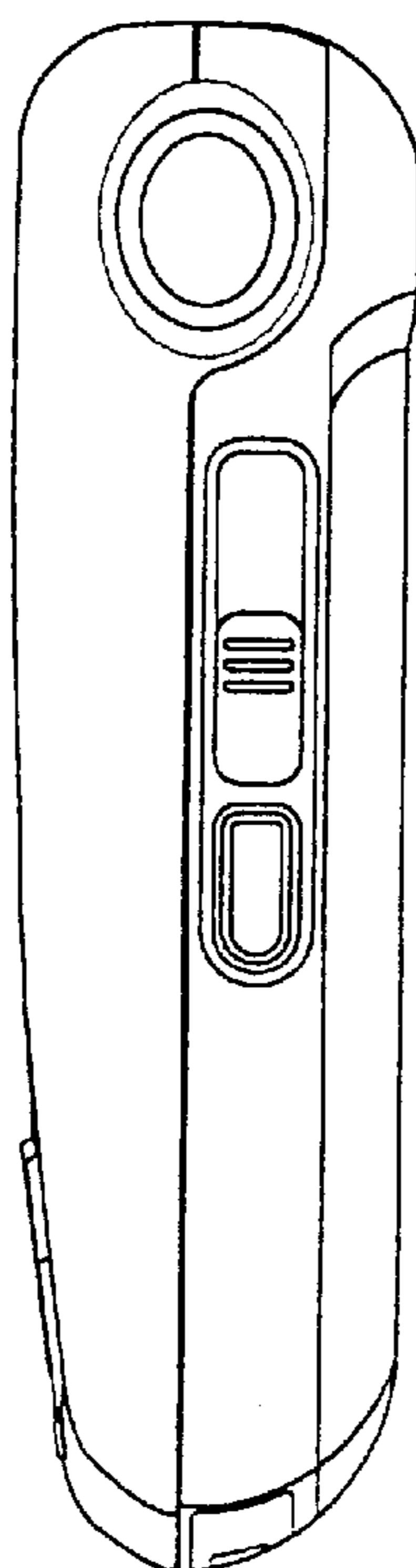

Fig. 6

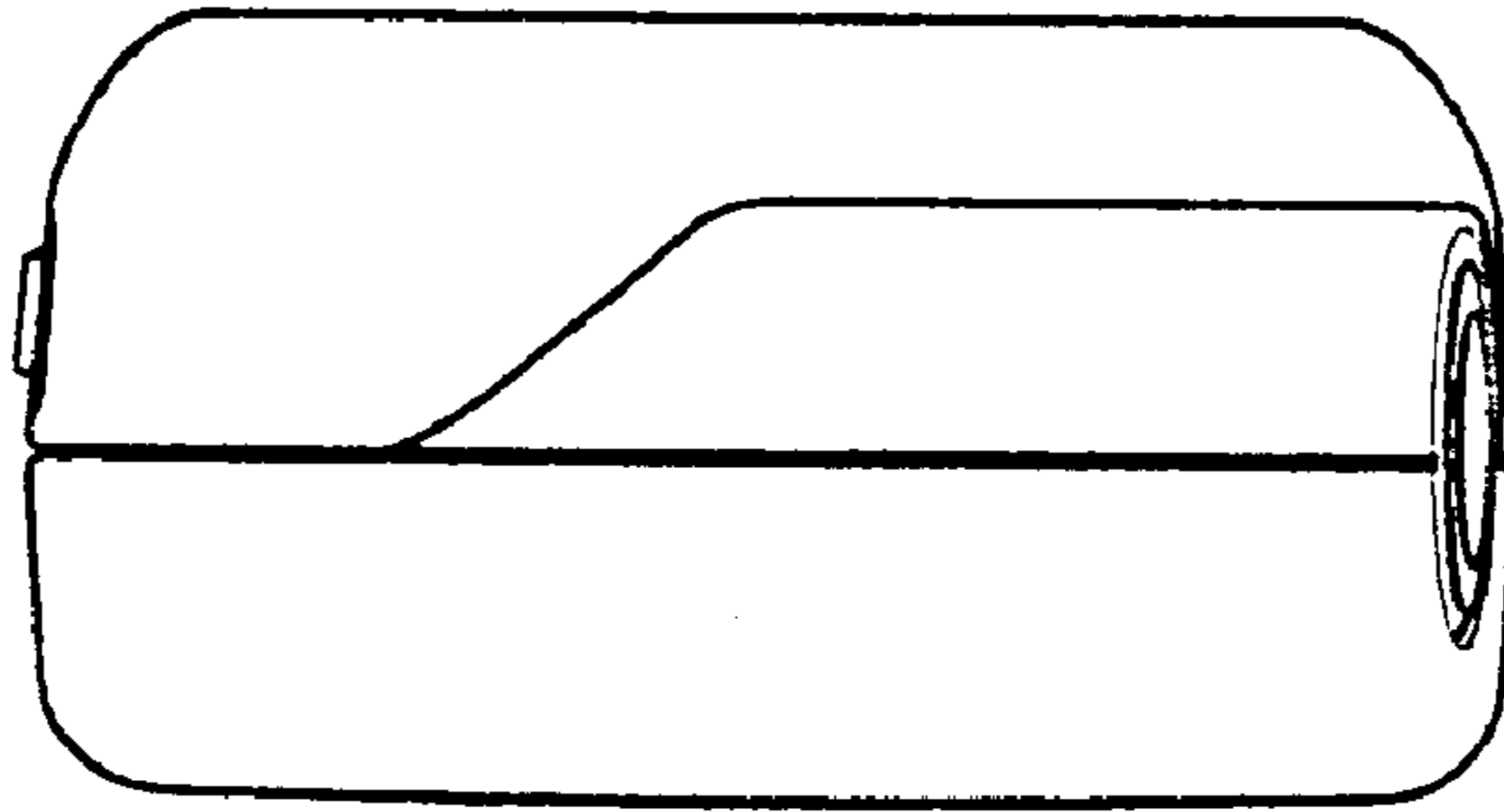

Fig. 7

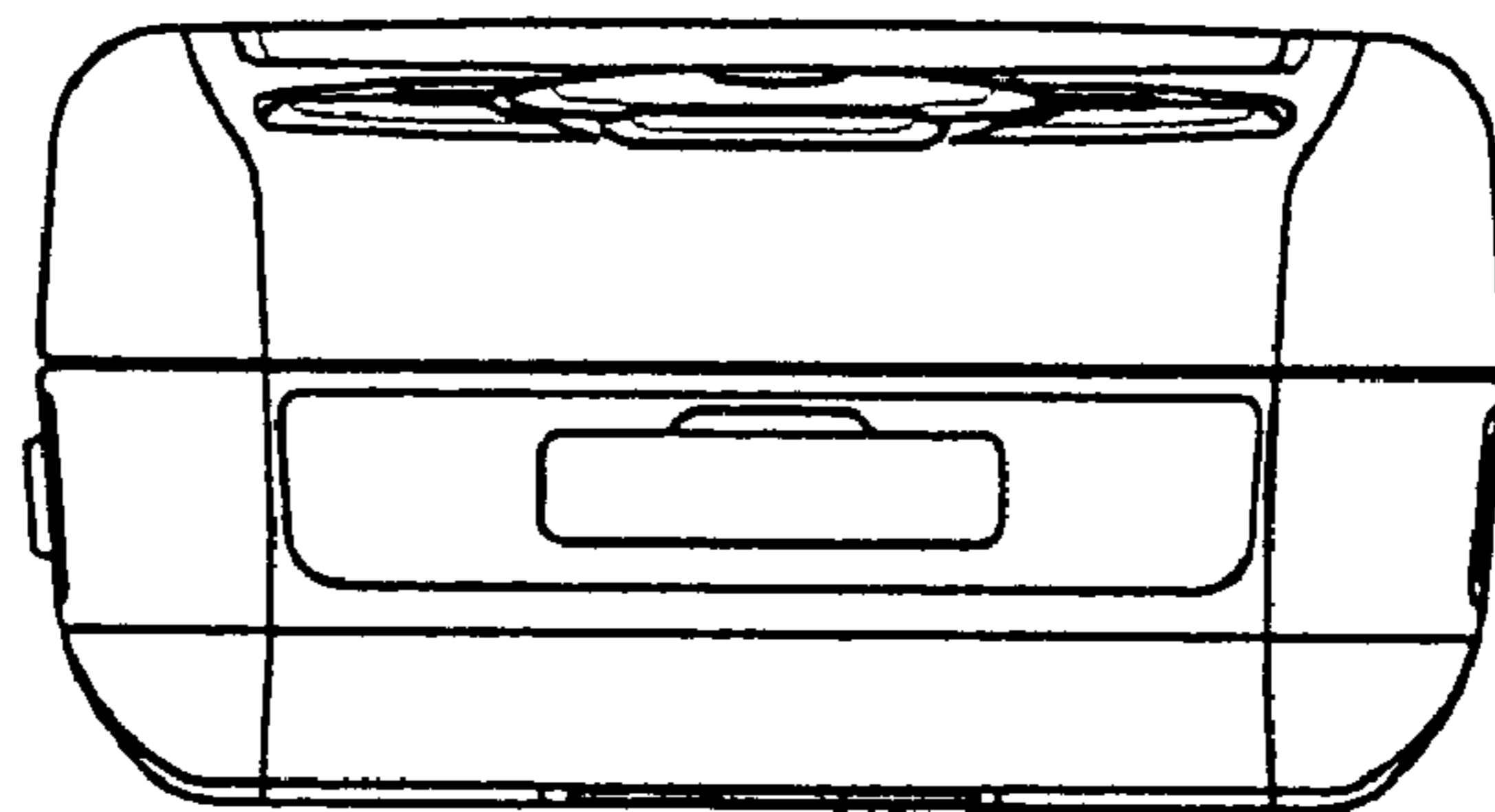

Fig. 8

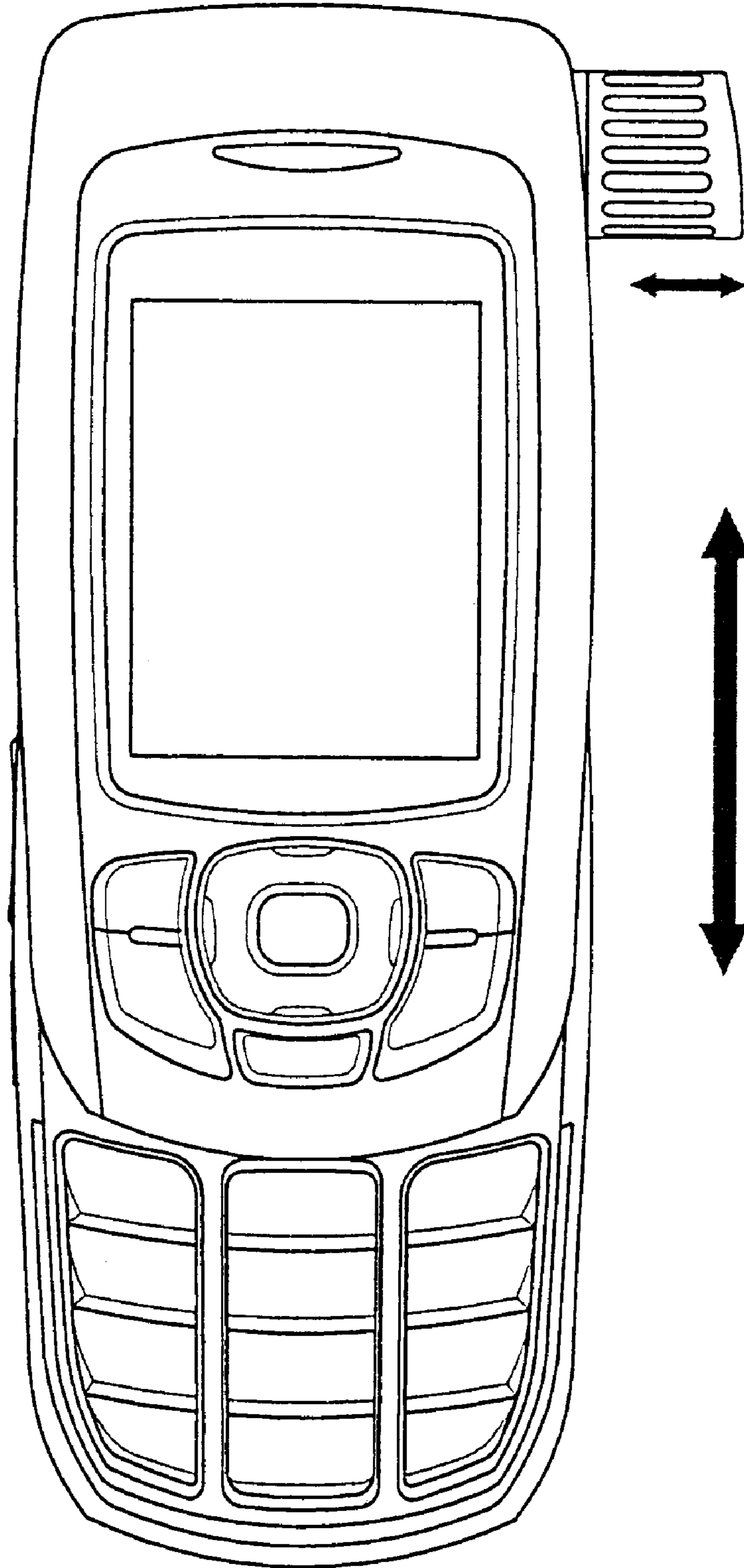

Fig. 9

