

US00D508687S

(12) **United States Design Patent** (10) **Patent No.:** **US D508,687 S**
Lee (45) **Date of Patent:** **** Aug. 23, 2005**

(54) **CELLULAR PHONE**
(75) **Inventor:** **Hyun Sung Lee, Seoul (KR)**
(73) **Assignee:** **Curitel Communications, Inc. (KR)**
(**) **Term:** **14 Years**

6,822,871 B2 * 11/2004 Lee et al. 361/727
D501,475 S * 2/2005 Kim D14/346
D502,162 S * 2/2005 Kim et al. D14/138
2003/0064688 A1 * 4/2003 Mizuta et al. 455/90
2004/0259592 A1 * 12/2004 Taneya et al. 455/556.1
2005/0009581 A1 * 1/2005 Im et al. 455/575.4
2005/0014538 A1 * 1/2005 Hyun et al. 455/575.4

(21) **Appl. No.:** **29/210,413**
(22) **Filed:** **Jul. 30, 2004**
(51) **LOC (8) Cl. 14-03**
(52) **U.S. Cl. D14/138**
(58) **Field of Search D14/137, 138,**
D14/147-148, 247-248, 144, 341-347;
379/433.01-433.13, 434; 455/550.1-90.3,
575.4, 566, 575.1, 556.1, 556.2, 575.6;
D21/517; 345/169

FOREIGN PATENT DOCUMENTS

JP 1088577 * 10/2000
JP 1120255 * 9/2001
JP 1124434 * 10/2001
JP 1160810 * 12/2002
JP 2003298699 A * 10/2003 H04M/1/02

OTHER PUBLICATIONS

NTT DoCoMo SO505i, (c) 2003, showings from NTT DoCoMo visited Apr. 10, 2003 and www.mobileburn.com visited Sep. 20, 2004.*

(56) **References Cited**

U.S. PATENT DOCUMENTS

D432,511 S * 10/2000 Eckholm D14/138
6,308,084 B1 * 10/2001 Lonka 455/556.1
D465,219 S * 11/2002 Tamaki et al. D14/346
D466,096 S * 11/2002 Takada D14/138
D469,367 S * 1/2003 Mirabelli et al. D10/65
D476,328 S * 6/2003 Miao et al. D14/346
D476,329 S * 6/2003 Miao et al. D14/346
D479,215 S * 9/2003 Yokoyama D14/138
D479,514 S * 9/2003 Chan D14/138
D480,697 S * 10/2003 Lee et al. D14/138
D481,692 S * 11/2003 Husgafvel D14/138
D485,267 S * 1/2004 Chien D14/346
D488,471 S * 4/2004 Yagawa et al. D14/346
D489,062 S * 4/2004 Hong D14/343
D493,156 S * 7/2004 Hamann et al. D14/138
D493,457 S * 7/2004 Hsu D14/346
D494,151 S * 8/2004 Walliser et al. D14/138
D495,310 S * 8/2004 Husgafvel D14/138
6,785,395 B1 * 8/2004 Arneson et al. 381/334
D496,343 S * 9/2004 Lin et al. D14/138
D496,644 S * 9/2004 Yoo et al. D14/138
D498,736 S * 11/2004 Lee D14/138
D498,737 S * 11/2004 Park et al. D14/138
D498,754 S * 11/2004 Blyth D14/341

* cited by examiner

Primary Examiner—Jeffrey Asch
(74) *Attorney, Agent, or Firm*—Blakely Sokoloff Taylor & Zafman

(57) **CLAIM**

The ornamental design for cellular phone, as shown and described.

DESCRIPTION

FIG. 1 is a perspective view of the cellular phone showing the new design;
FIG. 2 is a front elevation view thereof;
FIG. 3 is a rear elevation view thereof;
FIG. 4 is a left-side elevation view thereof;
FIG. 5 is a right-side elevation view thereof;
FIG. 6 is top plan view thereof;
FIG. 7 is bottom elevation view thereof;
FIG. 8 is a left-side elevation view showing open position, by sliding, thereof; and,
FIG. 9 is a front elevation view showing open position thereof.

1 Claim, 7 Drawing Sheets

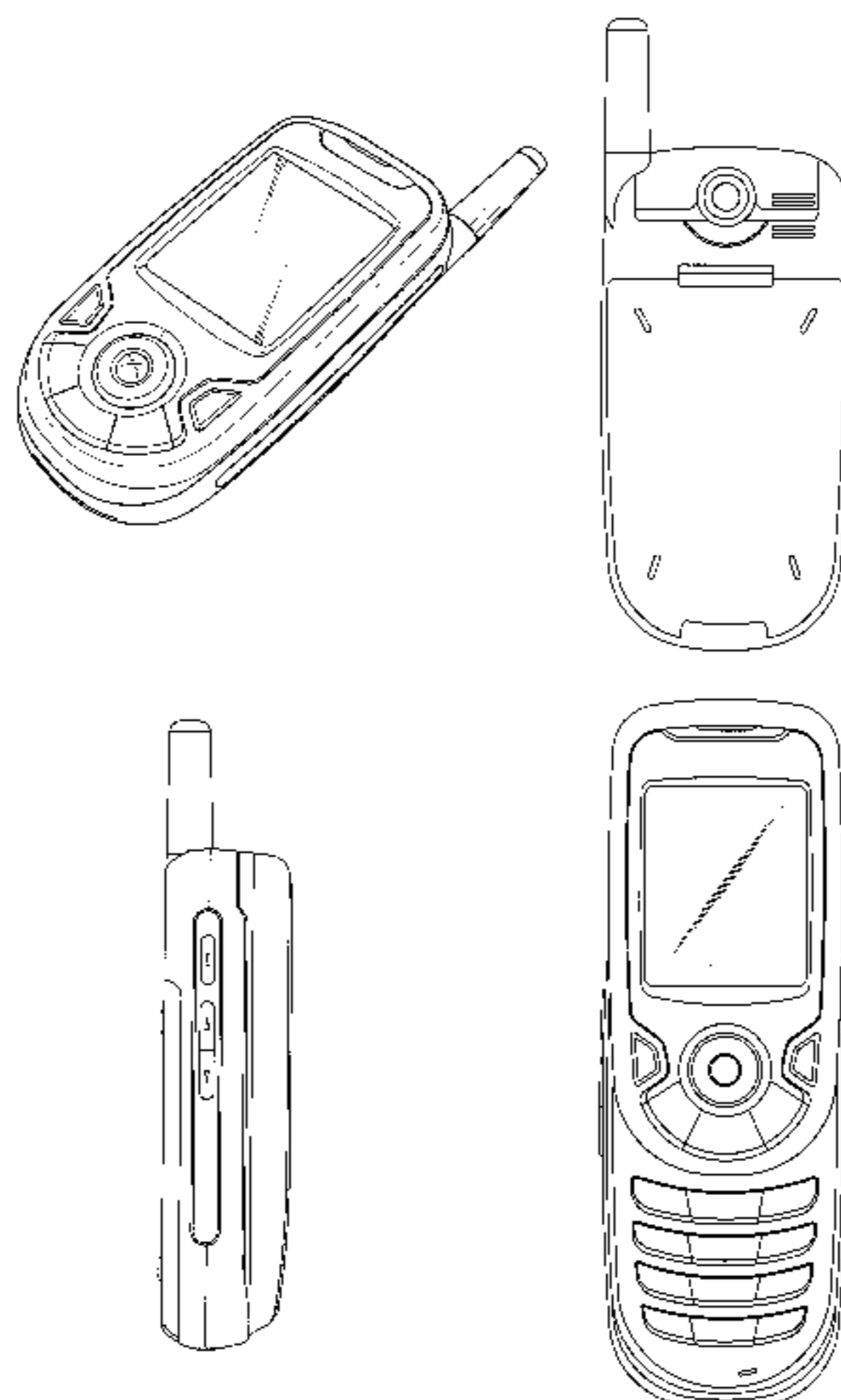

FIG. 1

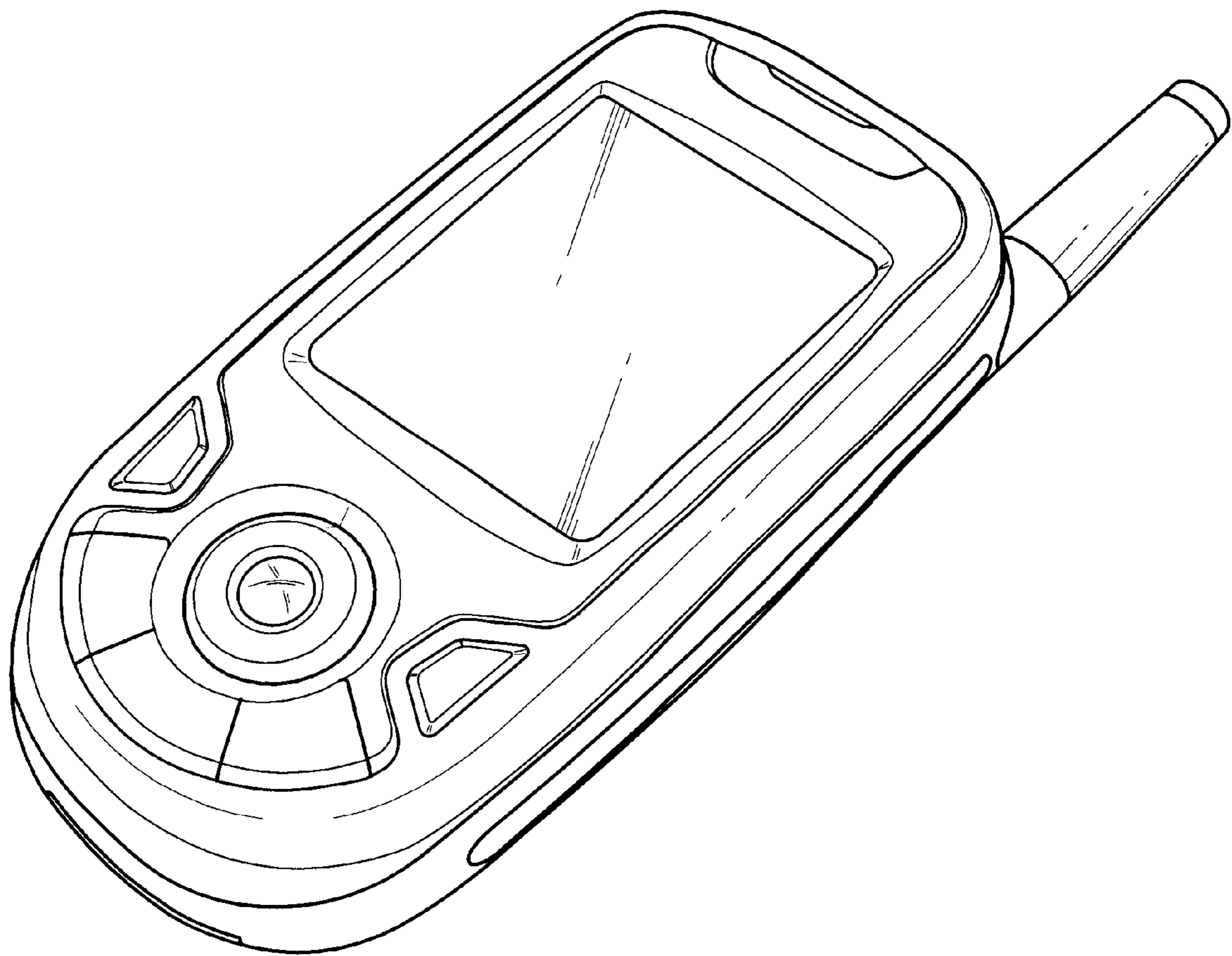

FIG. 2

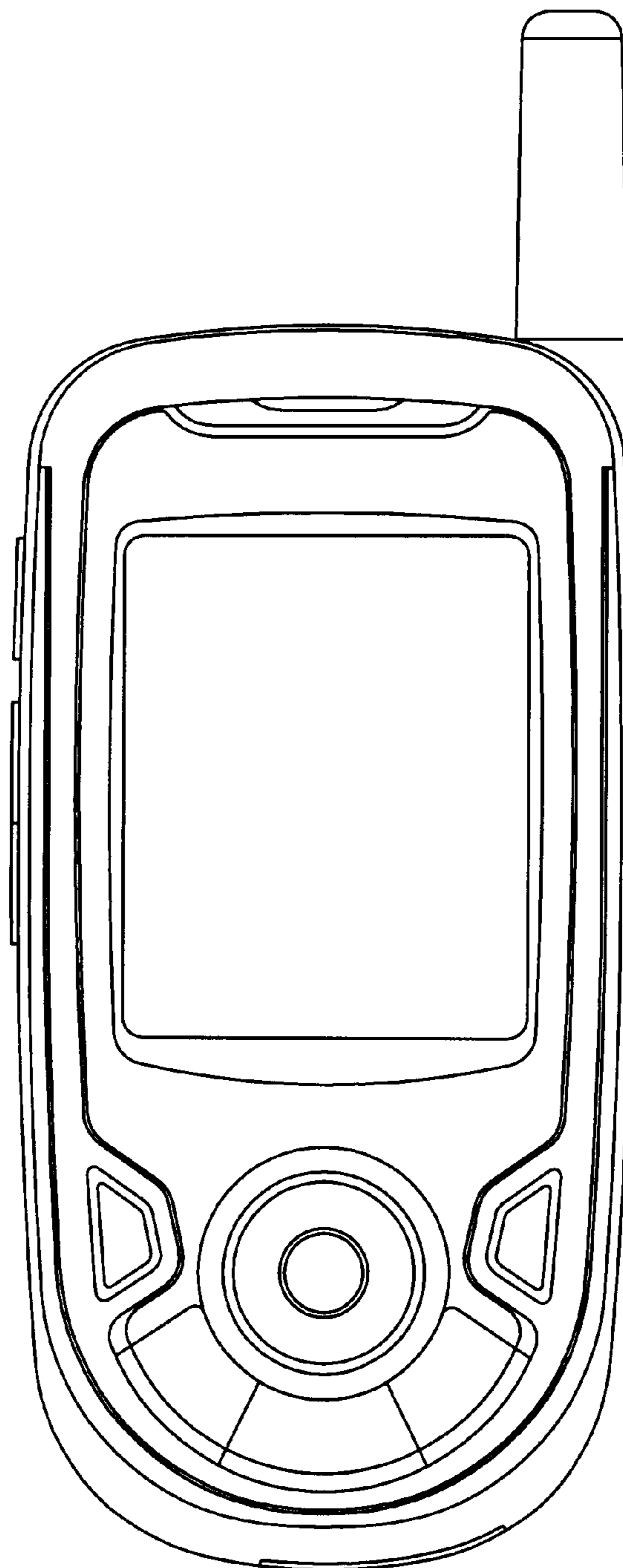

FIG. 3

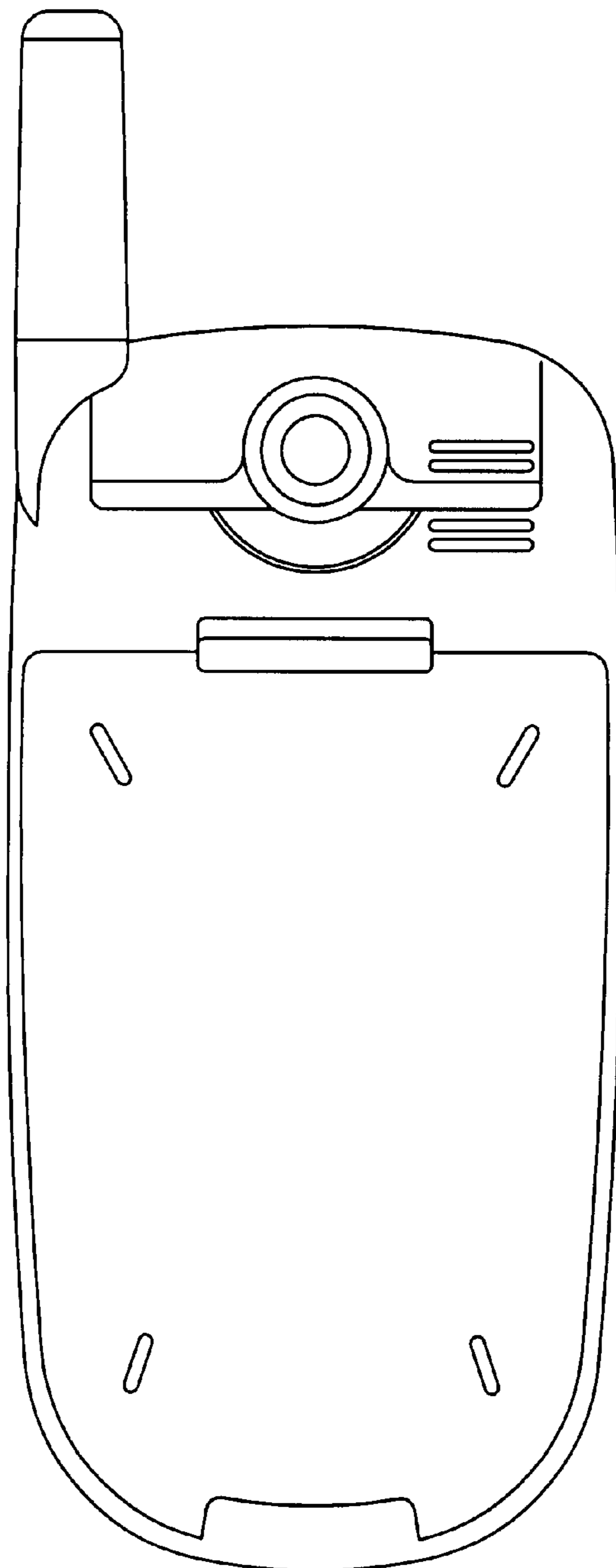

FIG. 4

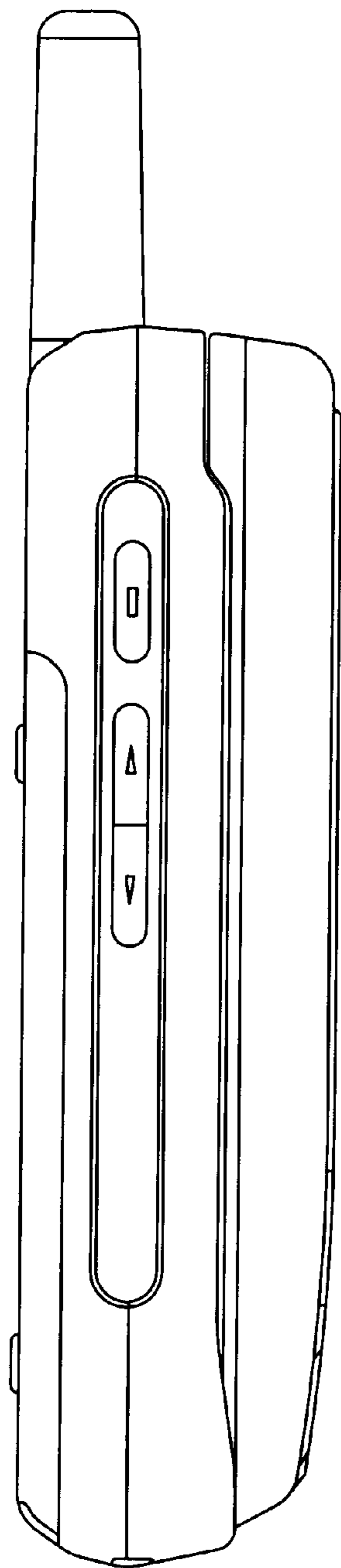

FIG. 5

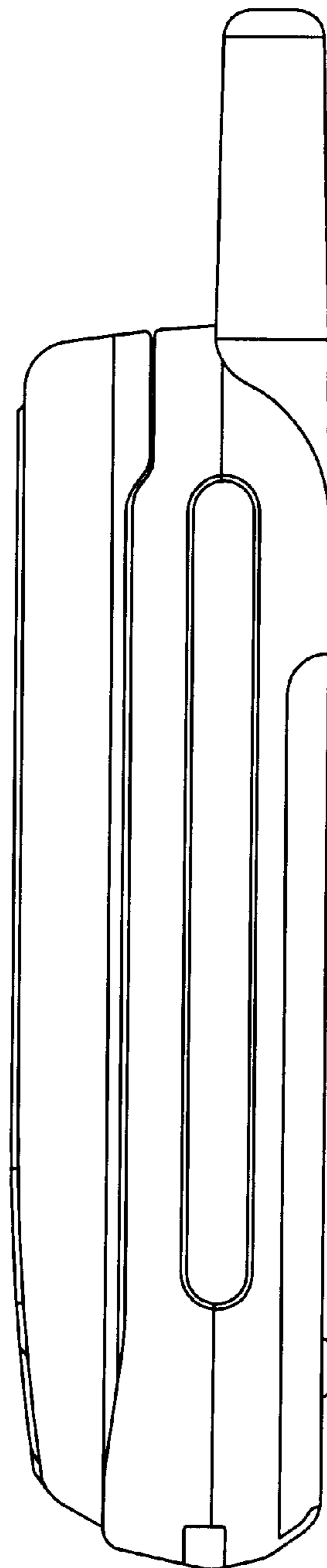

FIG. 6

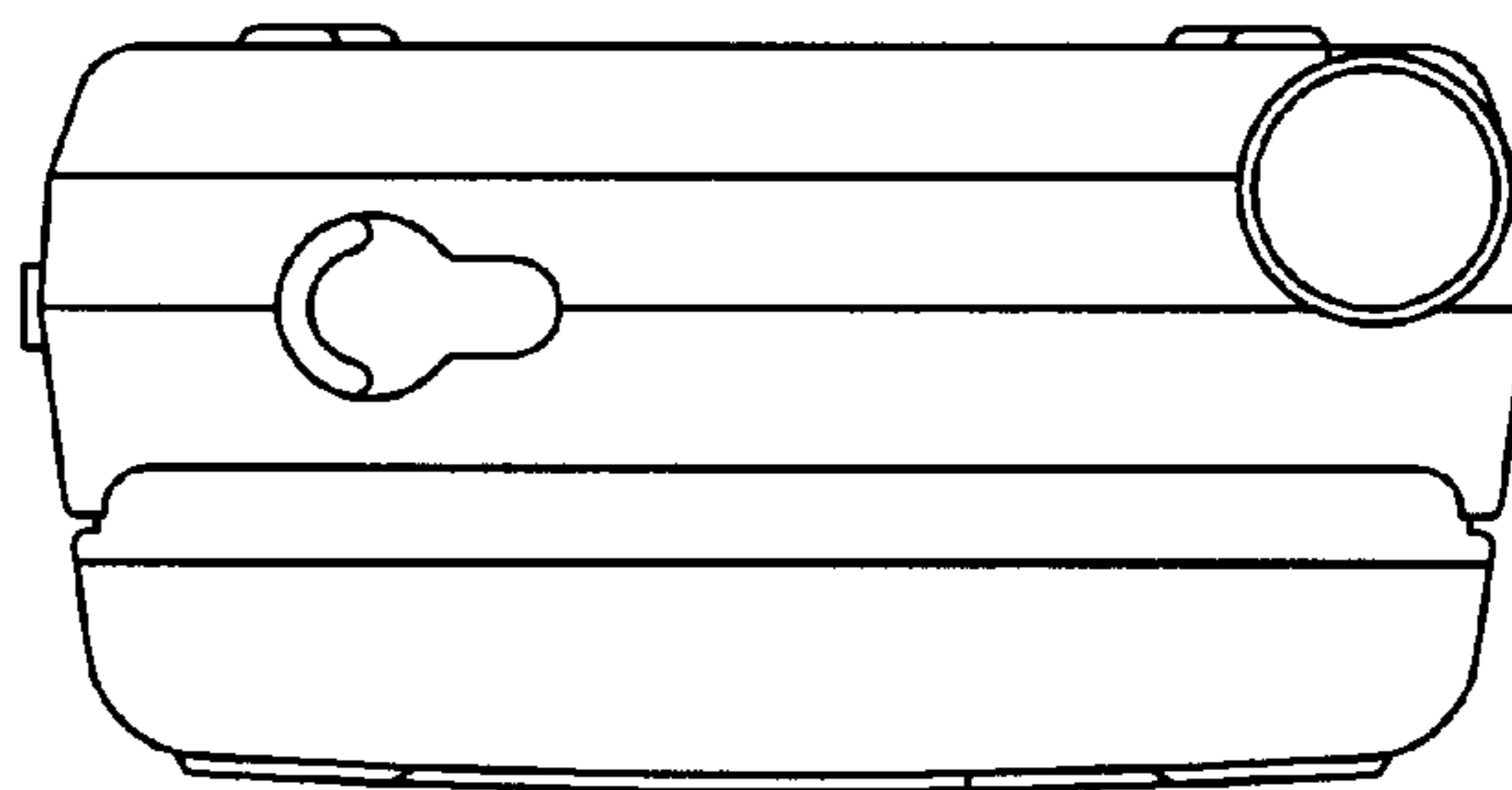

FIG. 7

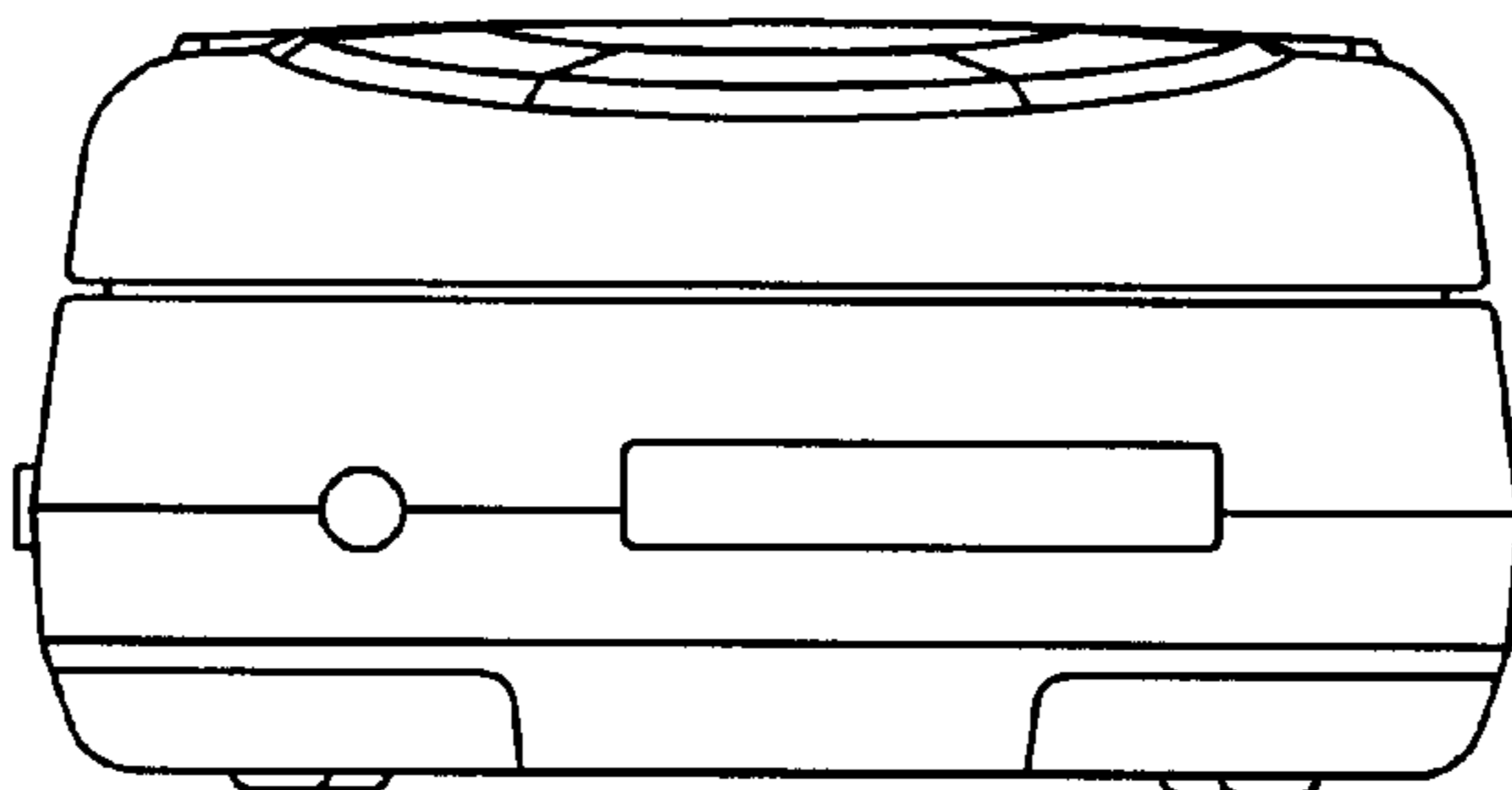

FIG. 8

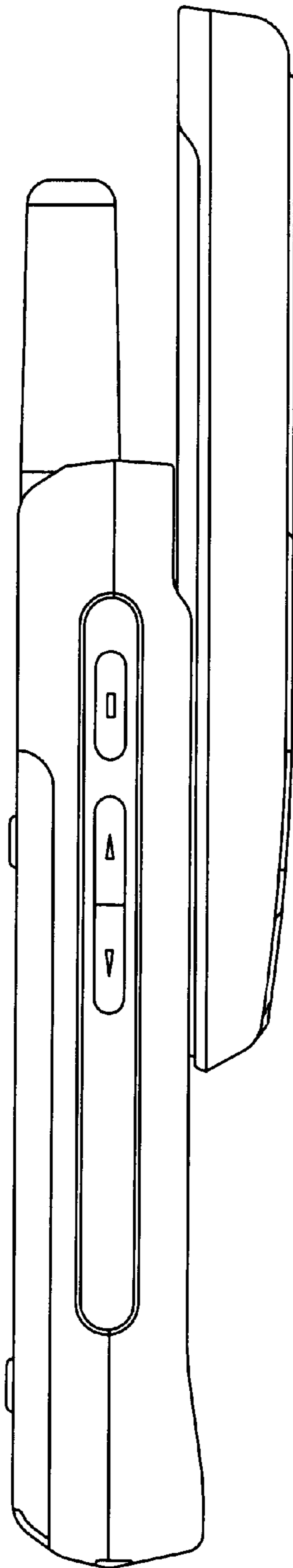

FIG. 9

