

US00D508476S

(12) **United States Design Patent** (10) **Patent No.:** **US D508,476 S**  
**Kim** (45) **Date of Patent:** **\*\* Aug. 16, 2005**

(54) **CELLULAR PHONE**

(75) **Inventor:** **Jong-Yoon Kim, Seoul (KR)**

(73) **Assignee:** **Curitel Communications, Inc. (KR)**

(\*\*) **Term:** **14 Years**

(21) **Appl. No.:** **29/210,403**

(22) **Filed:** **Jul. 30, 2004**

(51) **LOC (8) Cl. .... 14-03**

(52) **U.S. Cl. .... D14/138**

(58) **Field of Search** ..... D14/137, 138,  
D14/147-148, 247-248, 144, 341-347;  
379/433.01-433.13, 434; 455/550.1-90.3,  
575.3, 566, 575.1; D21/517

(56) **References Cited**

**U.S. PATENT DOCUMENTS**

D446,508 S	*	8/2001	Yoo et al. ....	D14/138
D447,741 S	*	9/2001	Lee et al. ....	D14/138
D458,594 S	*	6/2002	Jang .....	D14/138
D468,283 S	*	1/2003	Hong et al. ....	D14/138
D475,689 S	*	6/2003	Shimazu et al. ....	D14/138
D484,862 S	*	1/2004	Yang .....	D14/138
D485,248 S	*	1/2004	Ogawa .....	D14/138
D485,249 S	*	1/2004	Liao et al. ....	D14/138
D486,809 S	*	2/2004	Hwang .....	D14/138
D486,811 S	*	2/2004	Lheem .....	D14/138
D487,443 S	*	3/2004	Yoon .....	D14/138
D489,699 S	*	5/2004	Hwang et al. ....	D14/138
D490,065 S	*	5/2004	Shimazu et al. ....	D14/138
D490,792 S	*	6/2004	Lee .....	D14/138
D494,945 S	*	8/2004	Jang .....	D14/138
D495,672 S	*	9/2004	Jeon et al. ....	D14/138
D497,604 S	*	10/2004	Lee .....	D14/138

D498,220 S	*	11/2004	Park .....	D14/138
D500,016 S	*	12/2004	Kim .....	D14/138
D500,481 S	*	1/2005	Kim et al. ....	D14/138
2004/0097262 A1	*	5/2004	Lee .....	455/556.1
2004/0185920 A1	*	9/2004	Choi et al. ....	455/575.1
2004/0214619 A1	*	10/2004	Chiang .....	455/575.3
2004/0229666 A1	*	11/2004	Lee .....	455/575.1
2004/0248625 A1	*	12/2004	Yoshida et al. ....	455/575.1
2005/0003852 A1	*	1/2005	Song .....	455/550.1

**FOREIGN PATENT DOCUMENTS**

JP	D1154363	*	9/2002
JP	D1167658	*	1/2003
WO	DM/064560	*	10/2003

\* cited by examiner

*Primary Examiner*—Jeffrey Asch

(74) *Attorney, Agent, or Firm*—Blakely Sokoloff Taylor & Zafman

(57) **CLAIM**

The ornamental design for a cellular phone, as shown and described.

**DESCRIPTION**

FIG. 1 is a perspective view of the cellular phone showing the new design;  
FIG. 2 is a front elevation view thereof;  
FIG. 3 is a rear elevation view thereof;  
FIG. 4 is a left-side elevation view thereof;  
FIG. 5 is a right-side elevation view thereof;  
FIG. 6 is a top plan view thereof;  
FIG. 7 is a bottom plan view thereof; and,  
FIG. 8 is a front elevation view showing open position thereof.

**1 Claim, 5 Drawing Sheets**

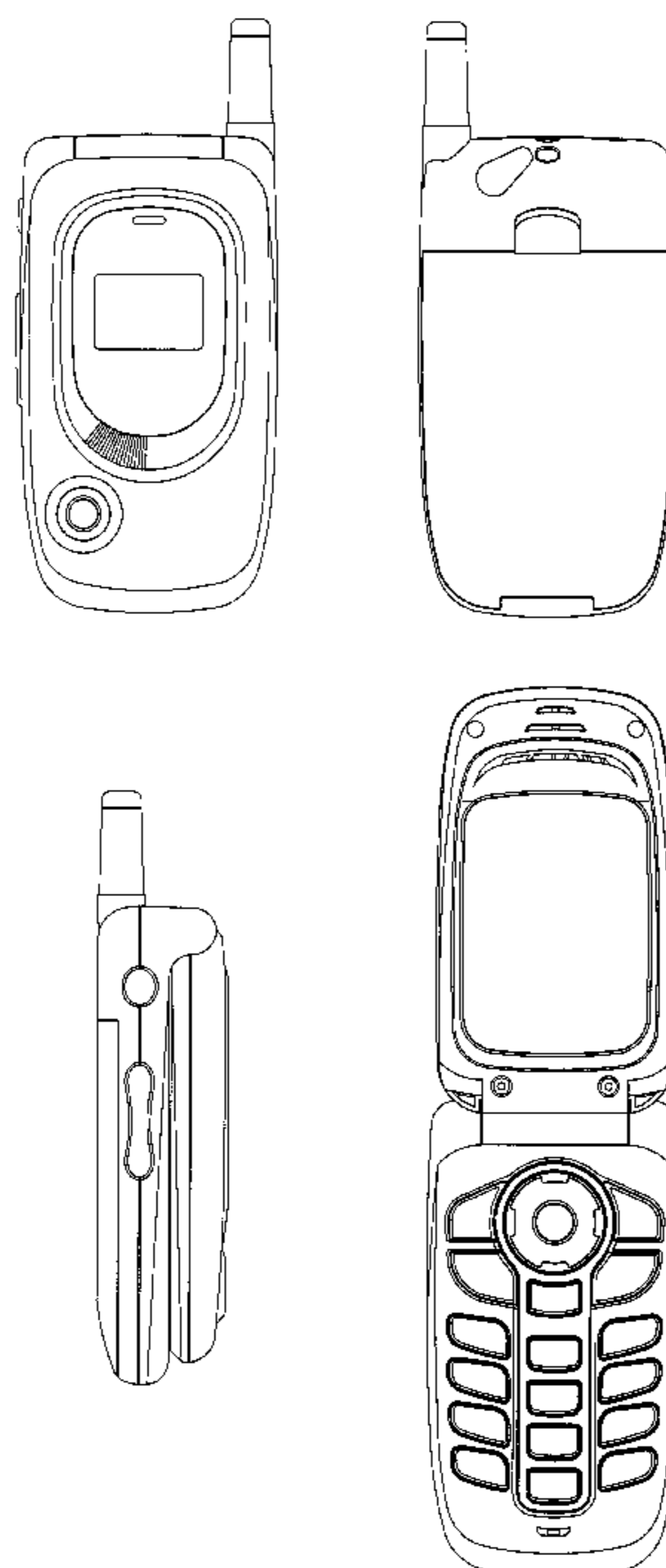

FIG. 1

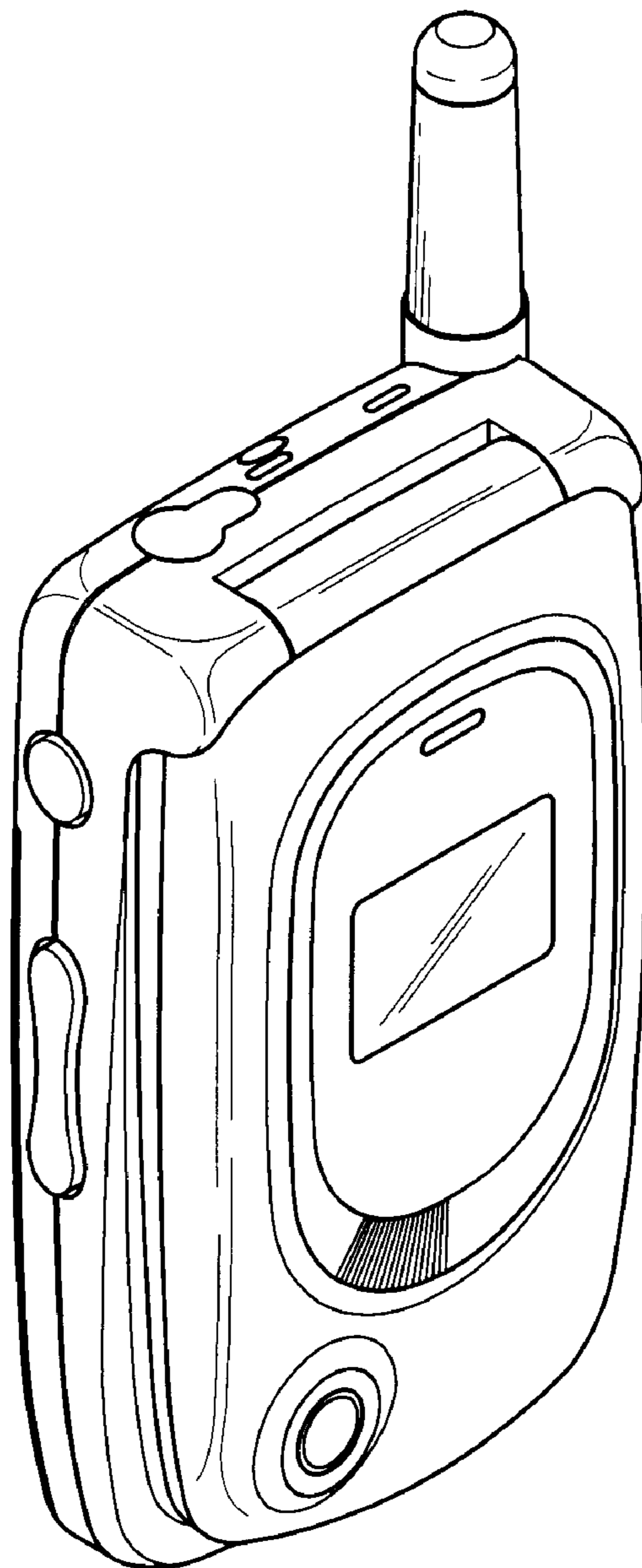

FIG. 2

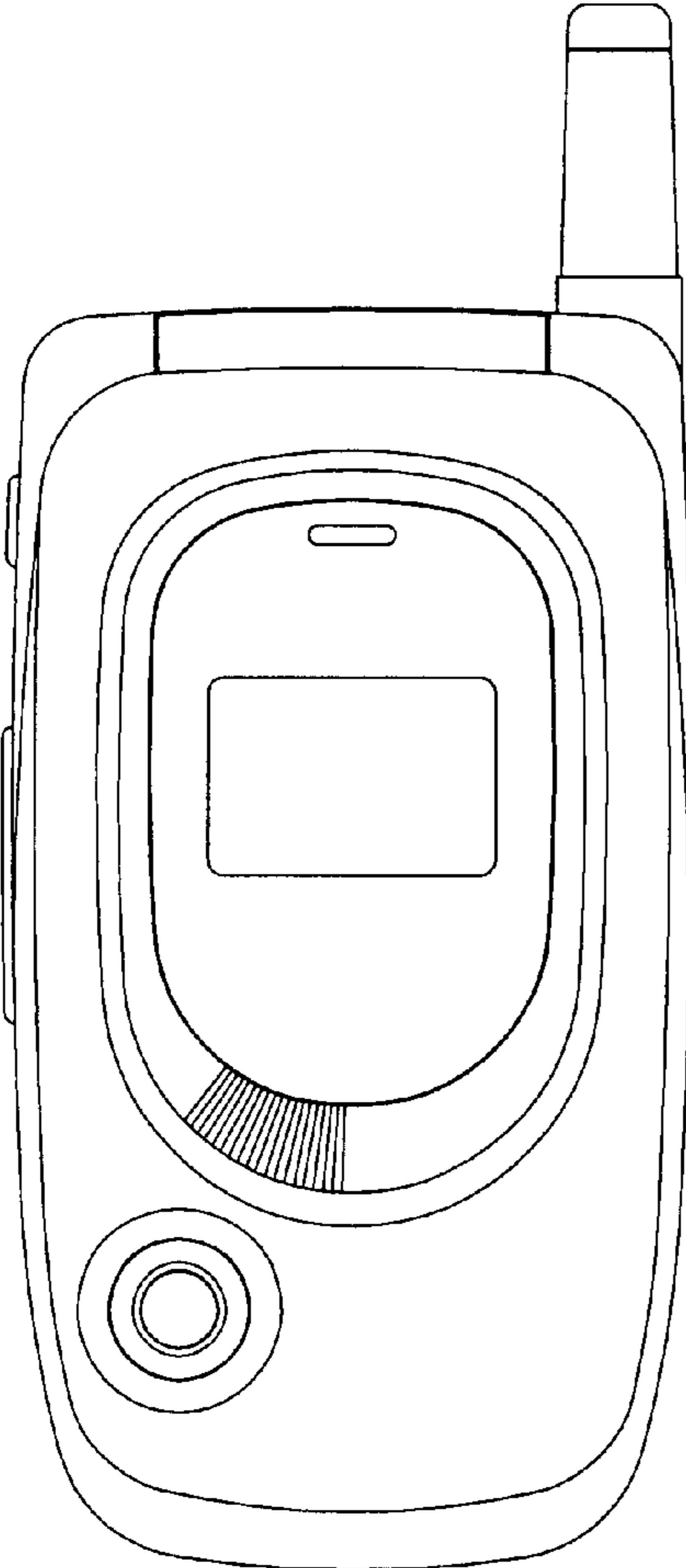

FIG. 3

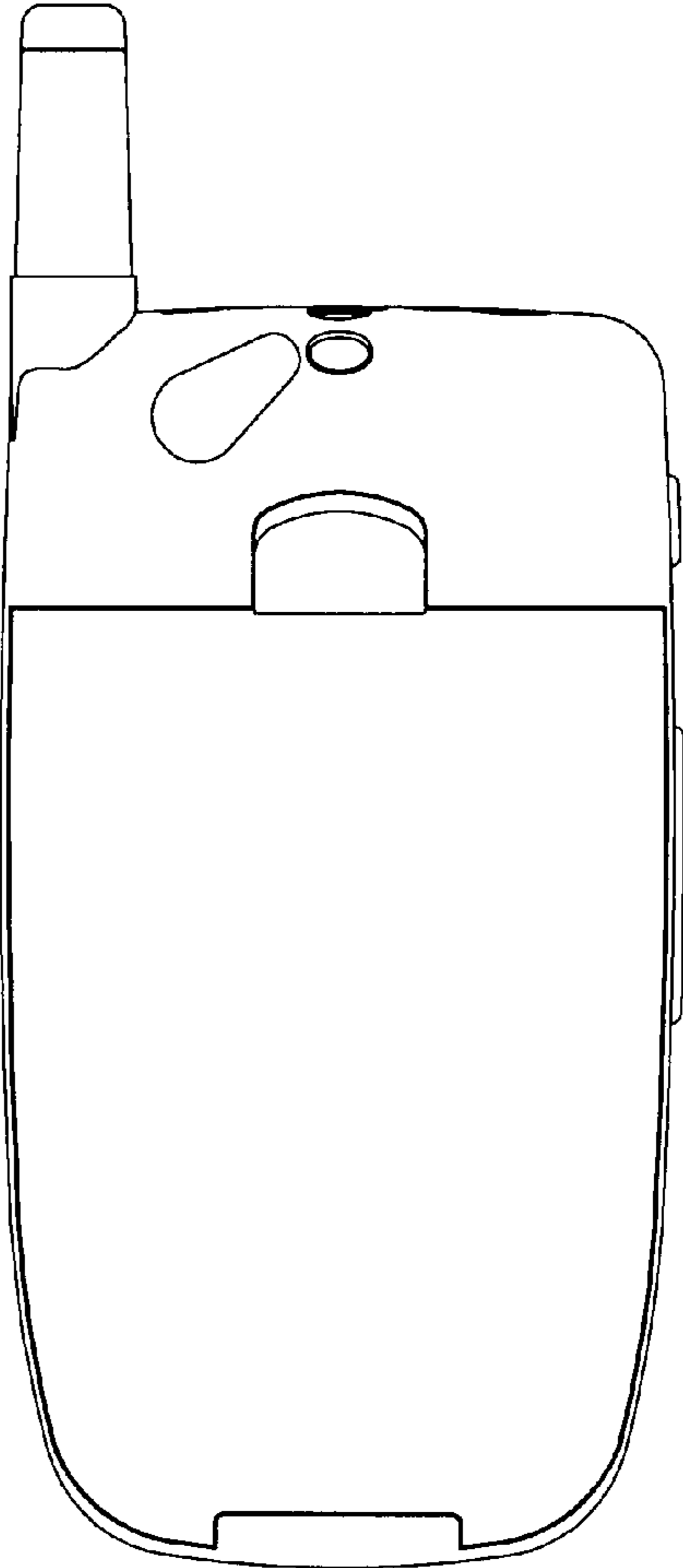

FIG. 4

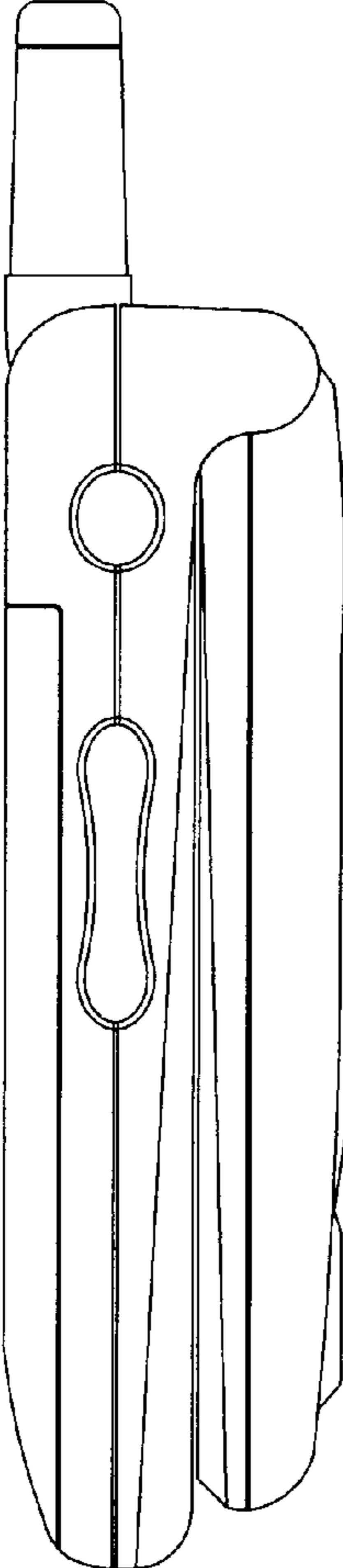

FIG. 5

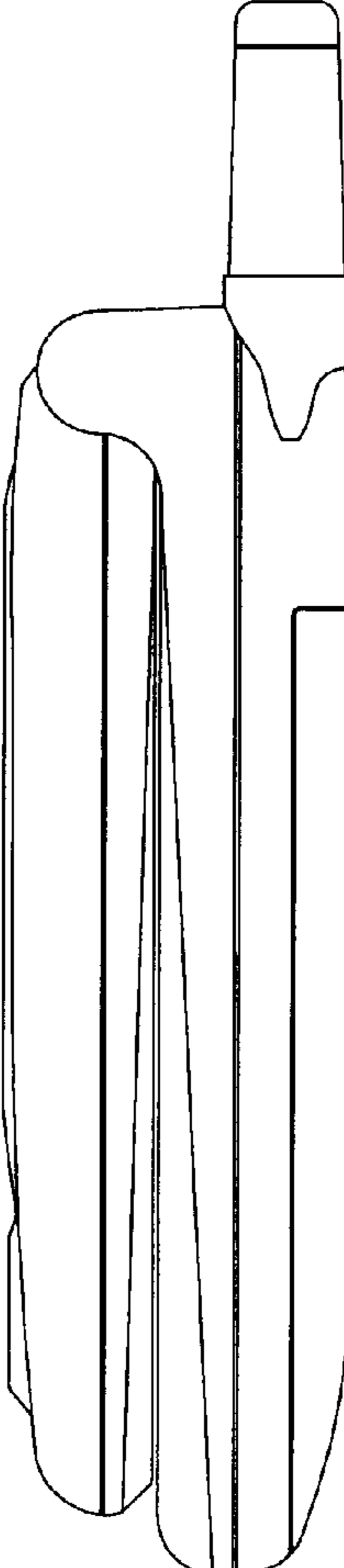

FIG. 6

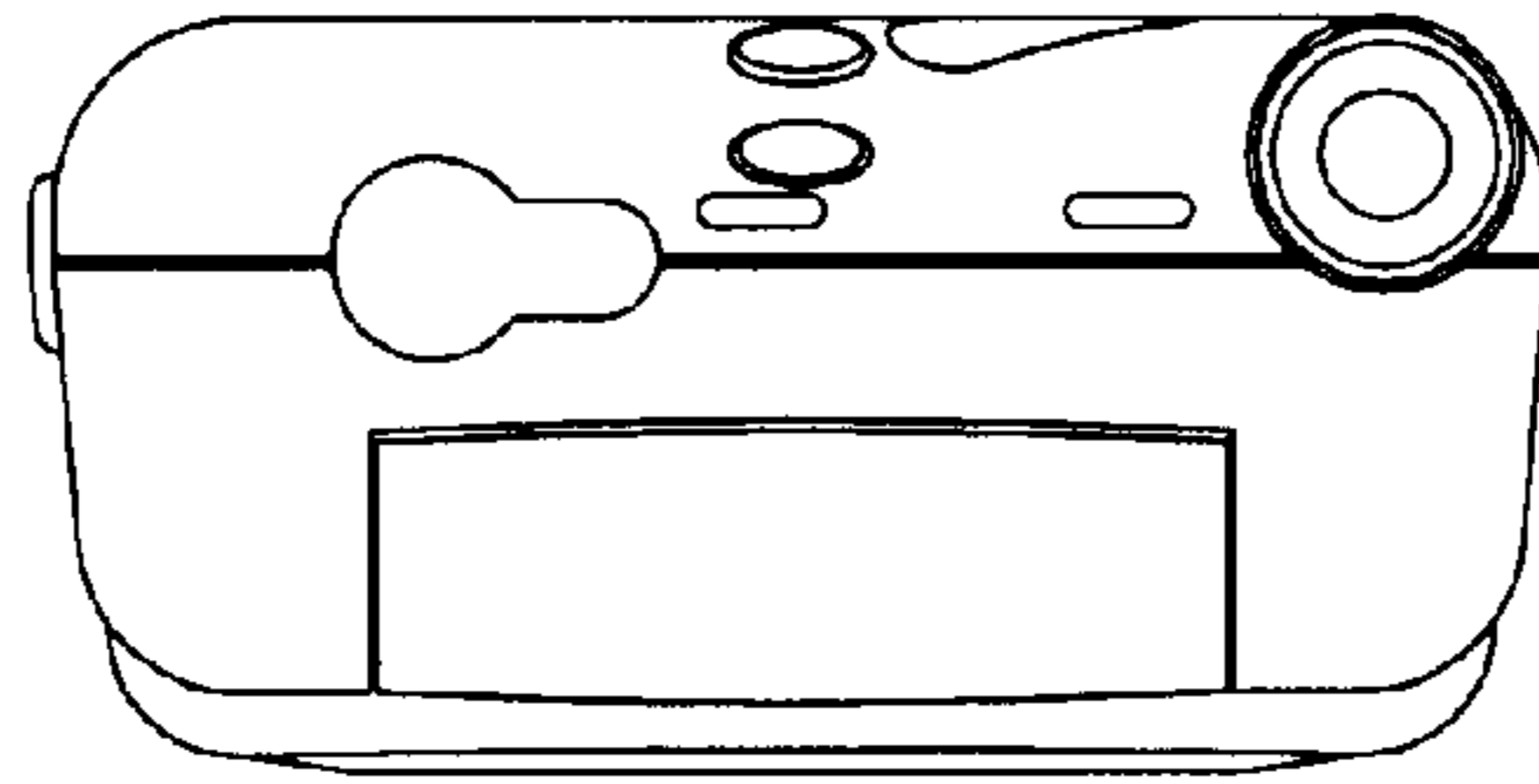

FIG. 7

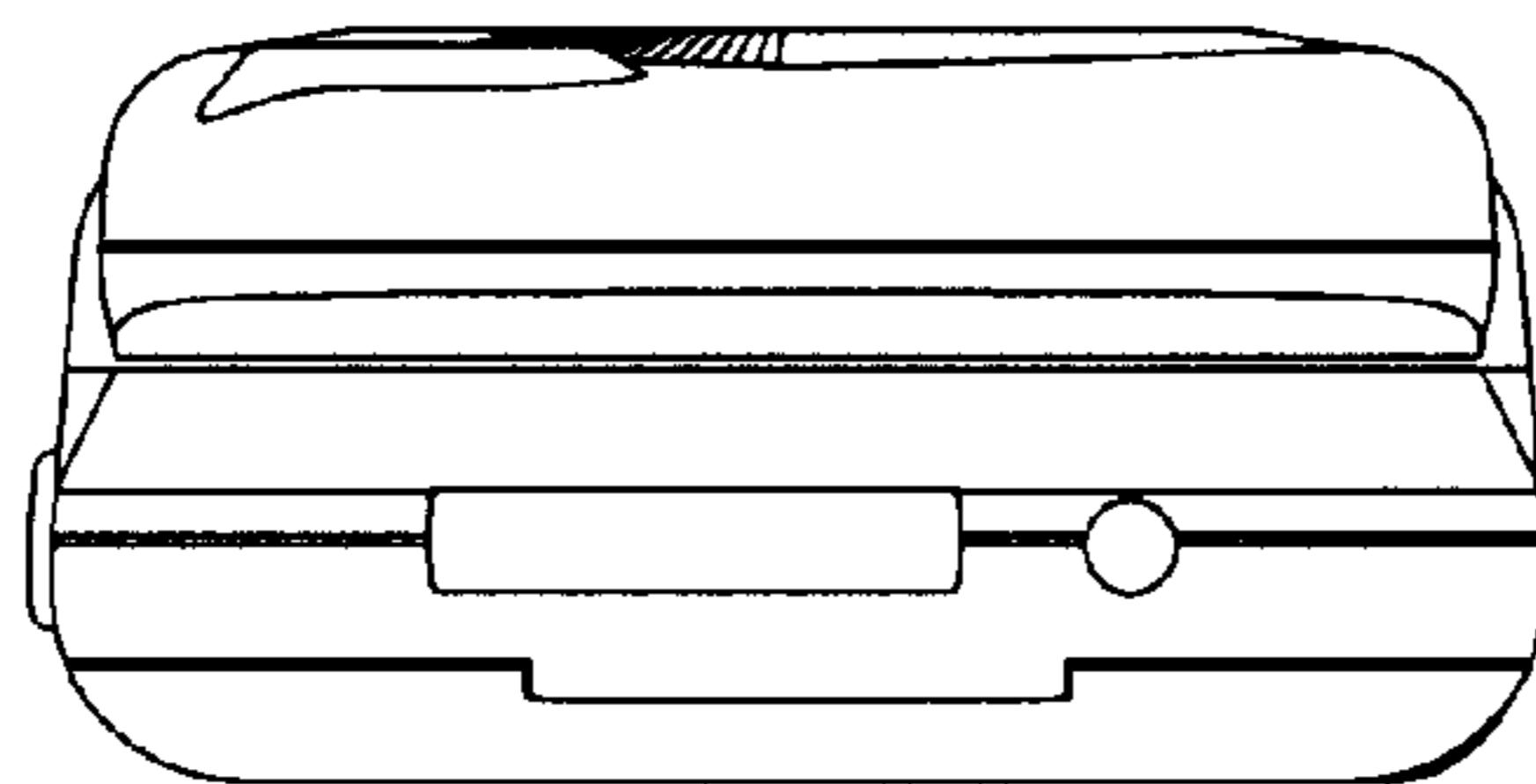

FIG. 8

