

US00D508347S

(12) **United States Design Patent**  
**Juneau et al.**

(10) **Patent No.: US D508,347 S**

(45) **Date of Patent: \*\* \*Aug. 16, 2005**

(54) **FURNITURE**

(75) Inventors: **Alain Juneau**, St-Jean-Chrysostome (CA); **Ivan Lacroix**, Sainte-Marie (CA)

(73) Assignee: **Baronet, Inc.** (CA)

(\*) Notice: This patent is subject to a terminal disclaimer.

(\*\*) Term: **14 Years**

(21) Appl. No.: **29/202,147**

(22) Filed: **Mar. 26, 2004**

(51) **LOC (8) Cl.** ..... **06-04**

(52) **U.S. Cl.** ..... **D6/446**

(58) **Field of Search** ..... D6/439, 441, 444-448;  
312/114, 204, 224, 278-279

(56) **References Cited**

**U.S. PATENT DOCUMENTS**

D189,784 S	2/1961	Swarts et al.	
D193,717 S	10/1962	Deaton	
D272,495 S	2/1984	Kemp, III et al.	
D394,171 S	* 5/1998	De Blaay	D6/446
D401,443 S	* 11/1998	Zaidman	D6/446
D427,453 S	7/2000	Lacroix et al.	
D427,806 S	7/2000	Lacroix et al.	
D440,430 S	* 4/2001	Hutton	D6/446
D445,596 S	7/2001	Stout et al.	
D473,401 S	4/2003	de Blois	
D493,043 S	* 7/2004	Juneau et al.	D6/446

**OTHER PUBLICATIONS**

Furniture Today, Montalbano Majestic Intl. dresser, p. 120, Oct. 16, 2000.\*

Thomasville, Bridges lingerie chest, p. 12, 2002.\*

Pending U.S. Appl. No. 29/186,481, filed Jul. 16, 2004.

\* cited by examiner

*Primary Examiner*—Cathron C. Brooks

(74) *Attorney, Agent, or Firm*—SAIDMAN DesignLaw Group

(57) **CLAIM**

The ornamental design for furniture, as shown and described.

**DESCRIPTION**

FIG. 1 is a perspective view of furniture showing our new design;

FIG. 2 is a top view thereof;

FIG. 3 is a front view thereof;

FIG. 4 is a right-side view thereof, the left-side view being a mirror image;

FIG. 5 is a perspective view of a second embodiment showing our new design; and,

FIG. 6 is a front view thereof.

The broken lines in the drawings, indicating that no particular handle shape is being claimed, represent environmental subject matter and form no part of the claimed design.

**1 Claim, 6 Drawing Sheets**

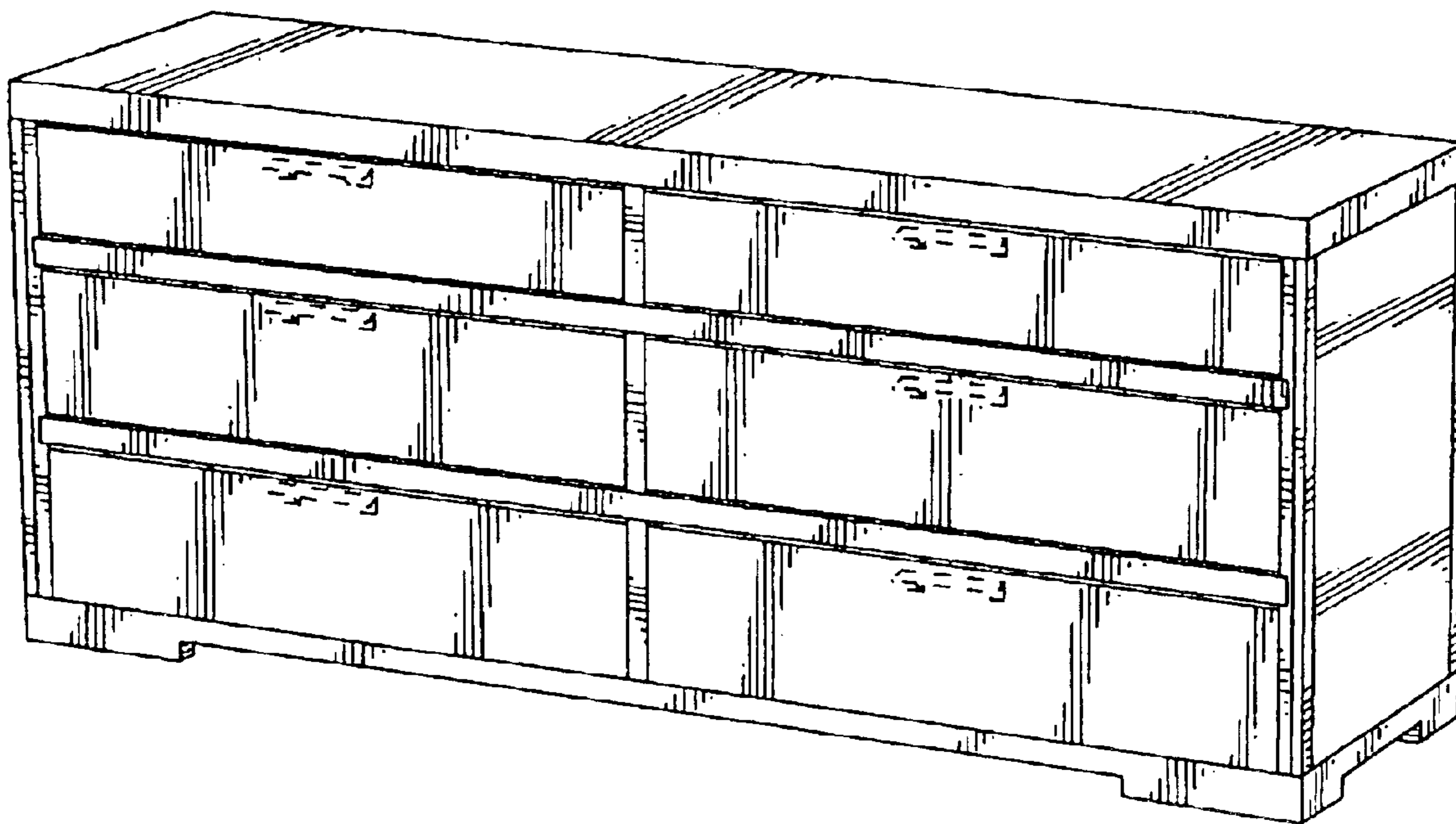

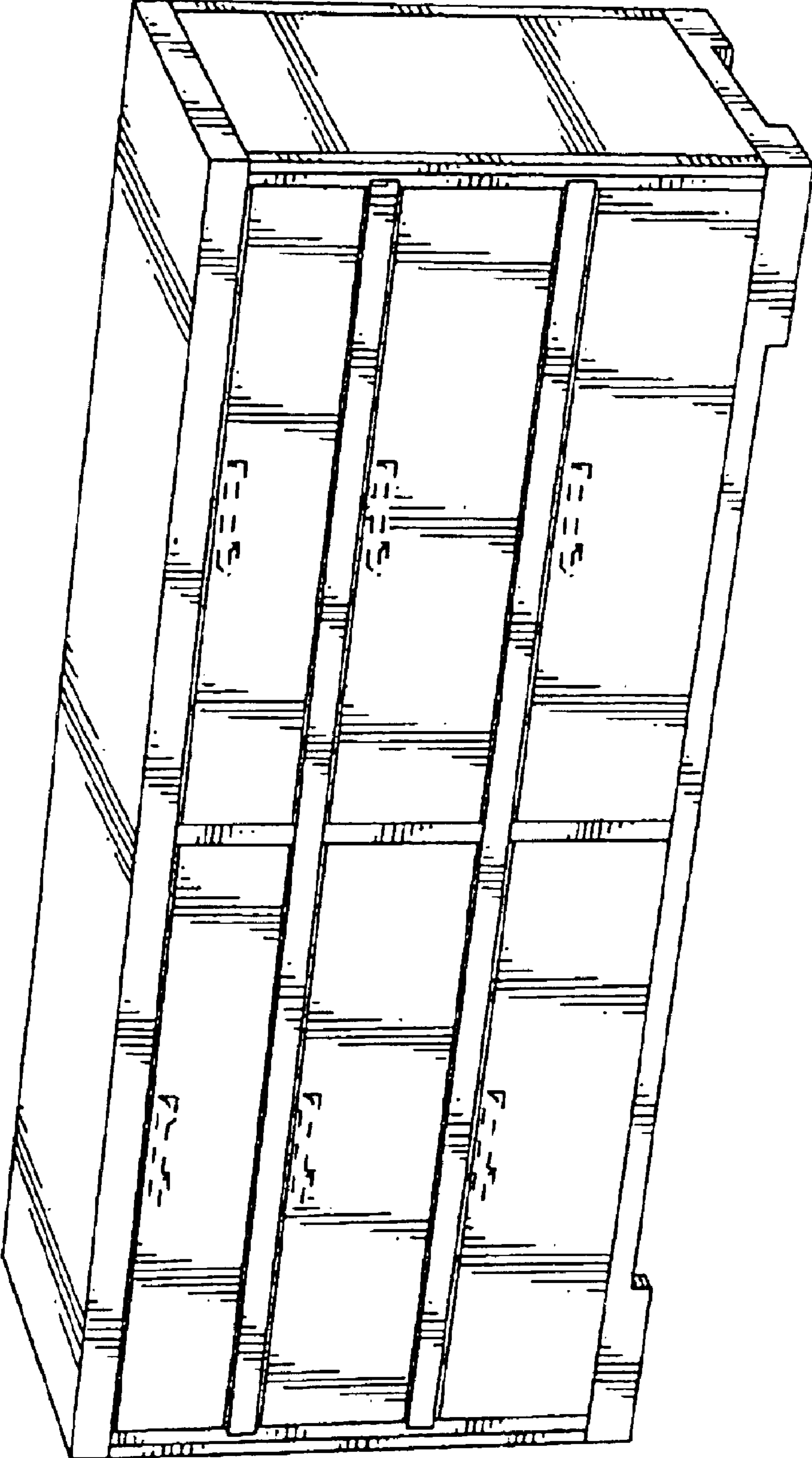

FIG.1

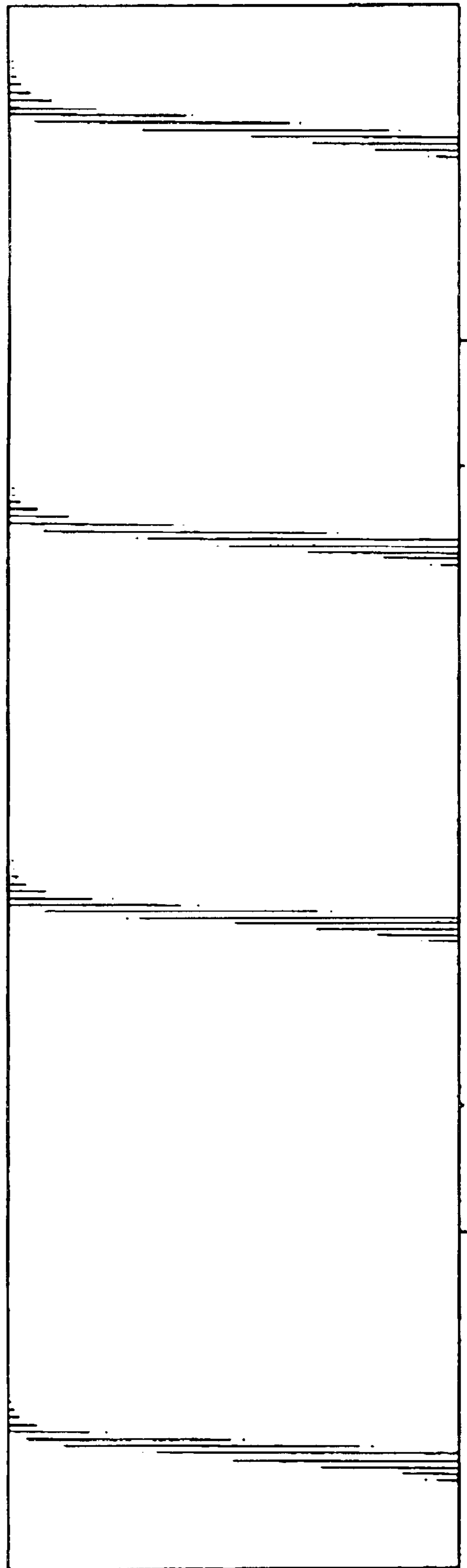

FIG.2

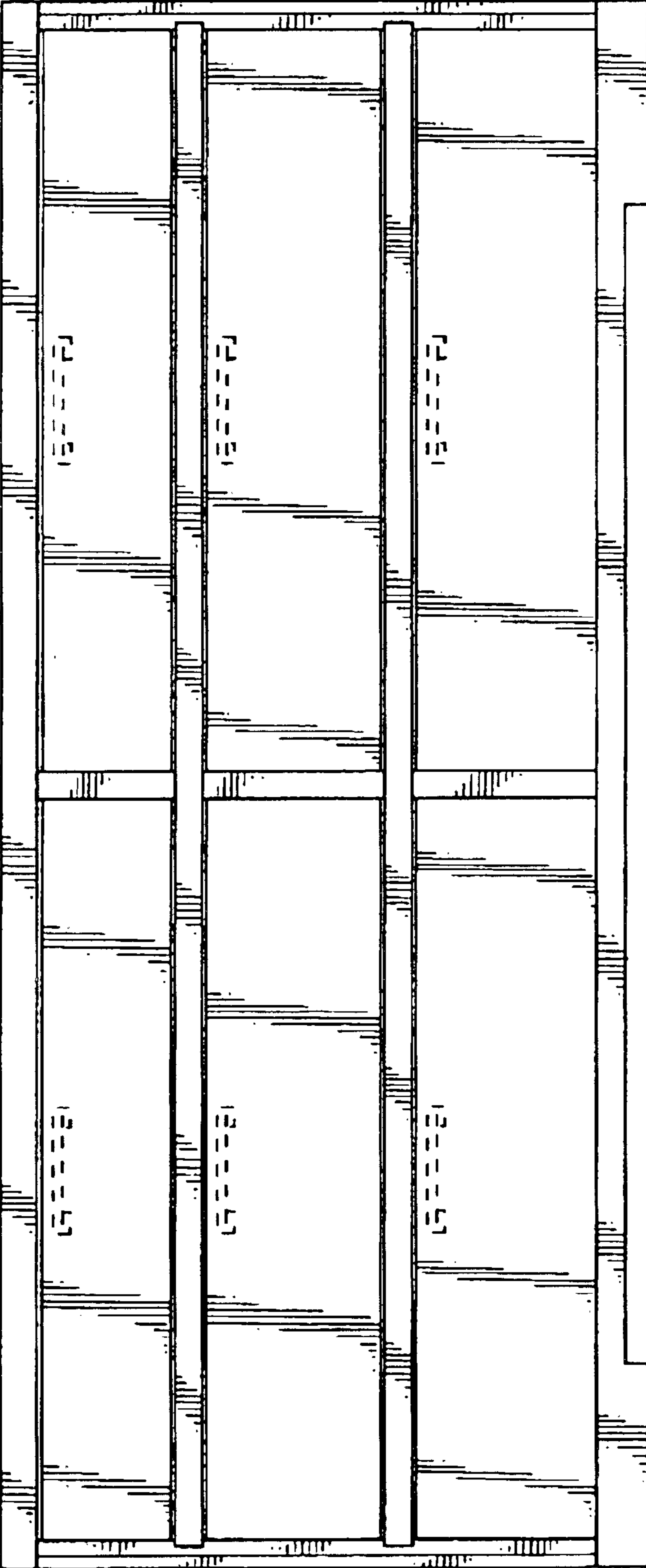
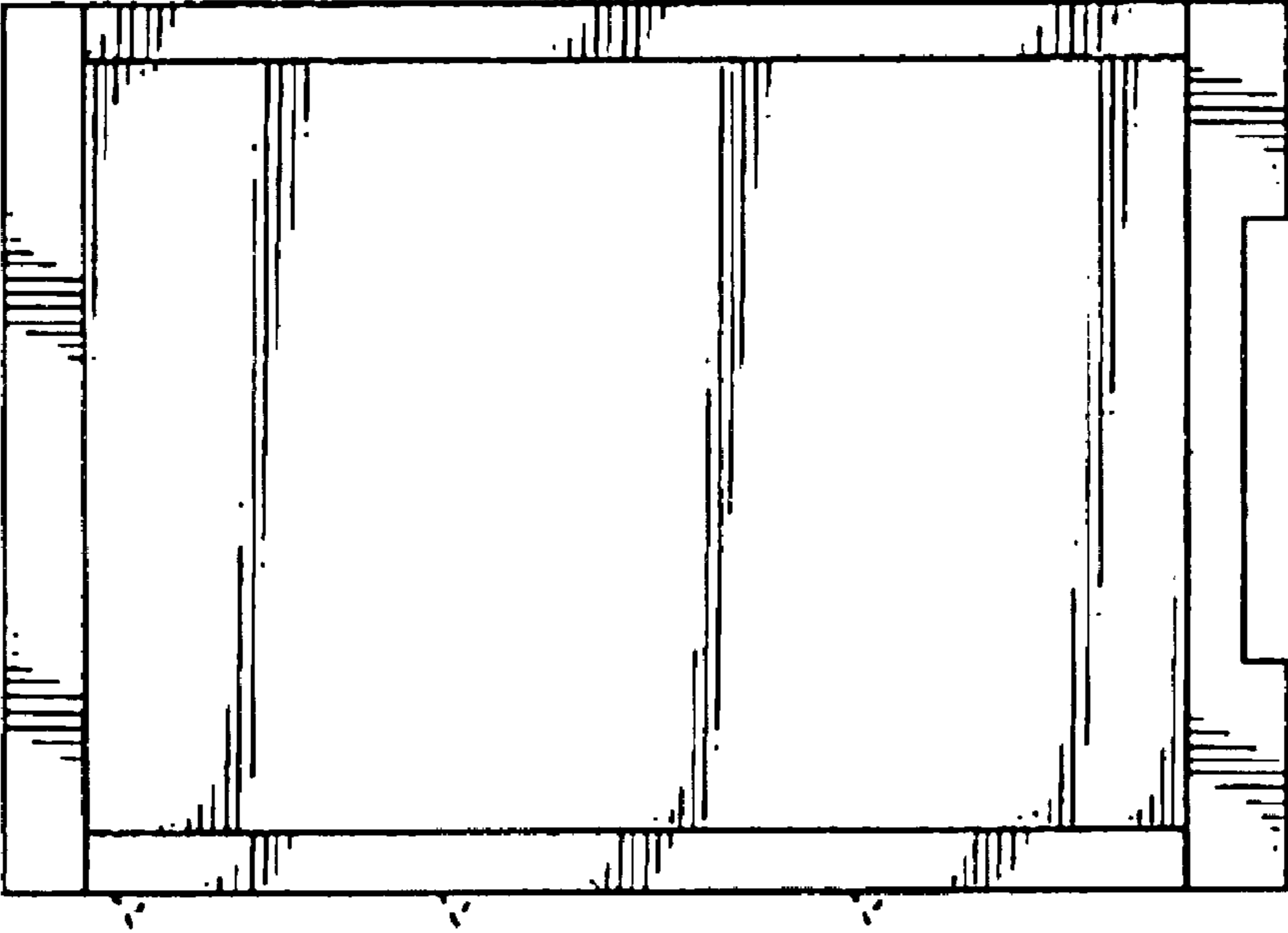
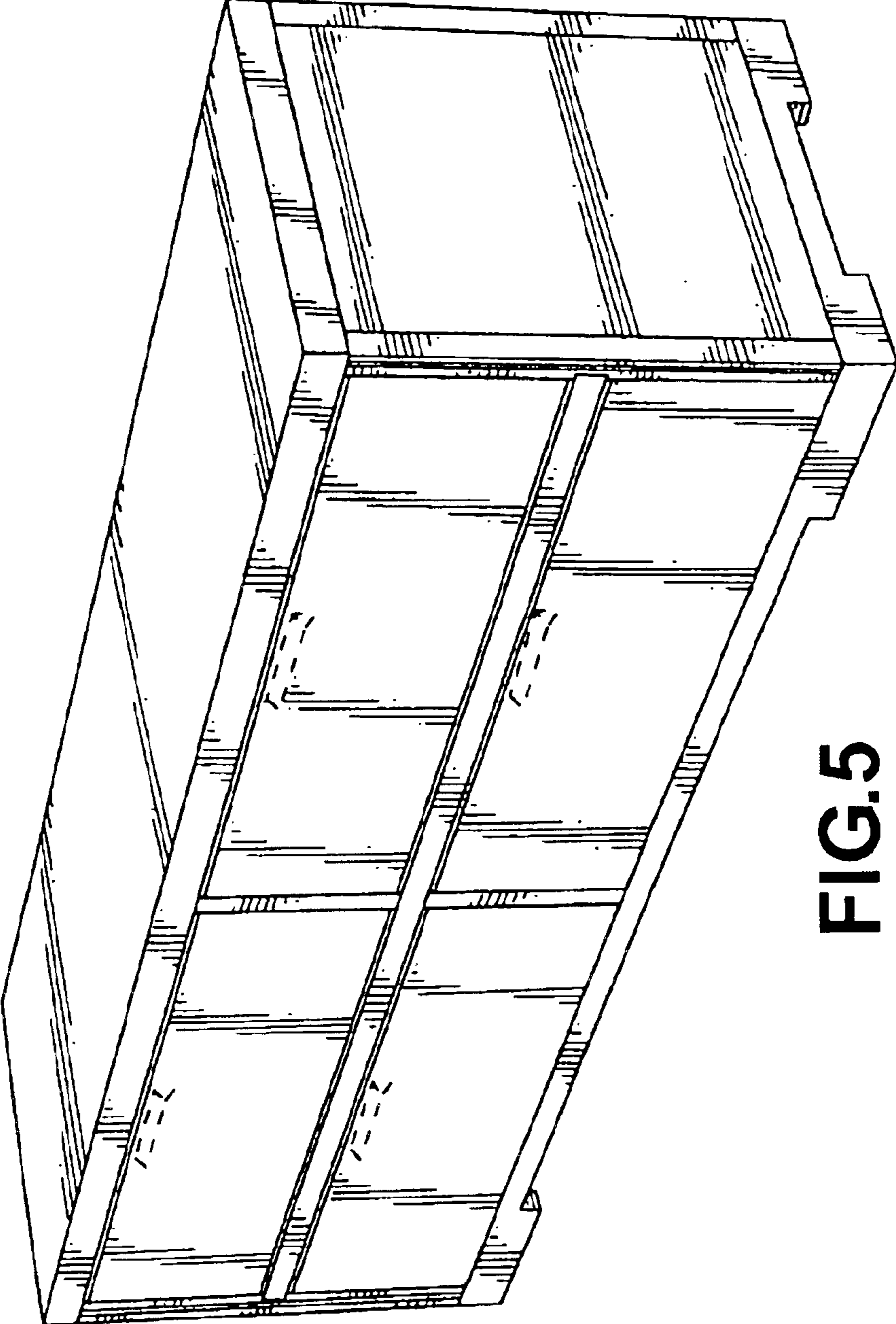

FIG.3



**FIG.4**



**FIG.5**

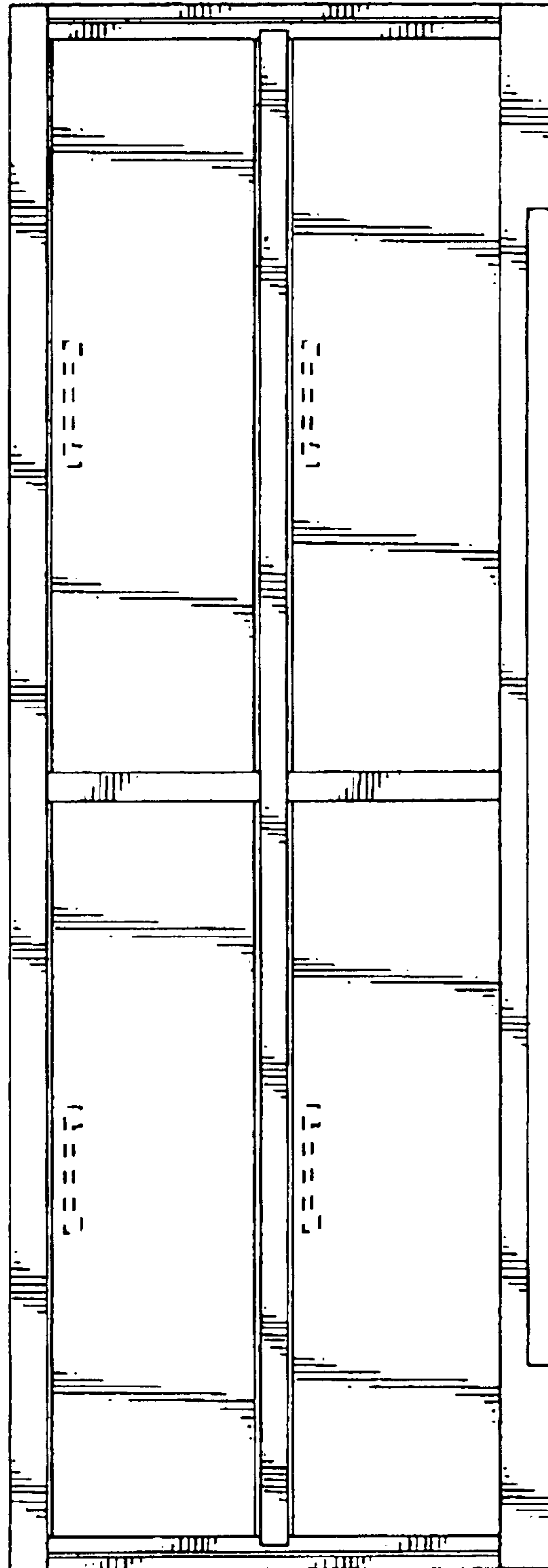

FIG.6