

US00D508142S

(12) **United States Design Patent**  
**Lizarraga**

(10) **Patent No.:** **US D508,142 S**

(45) **Date of Patent:** **\*\* Aug. 2, 2005**

(54) **LAMP**

(76) Inventor: **Hector M. Lizarraga**, 606 3<sup>rd</sup> Ave.  
#332, San Diego, CA (US) 92101

(\*\*) Term: **14 Years**

(21) Appl. No.: **29/202,026**

(22) Filed: **Mar. 23, 2004**

(51) **LOC (8) Cl.** ..... **26-03**

(52) **U.S. Cl.** ..... **D26/94**

(58) **Field of Search** ..... D26/93-112; 362/410-414,  
362/806; D11/157; 428/542.2, 542.4; D21/733,  
735; 40/358

(56) **References Cited**

**U.S. PATENT DOCUMENTS**

D328,150 S	*	7/1992	Tseng	.....	D26/94
D342,802 S	*	12/1993	Barletta	.....	D26/94
D343,696 S	*	1/1994	Ruxer	.....	D26/94
D363,100 S	*	10/1995	Long et al.	.....	D21/733

\* cited by examiner

*Primary Examiner*—Alan P. Douglas

*Assistant Examiner*—Linda Brooks

(74) *Attorney, Agent, or Firm*—Donn K. Harms

(57) **CLAIM**

The ornamental design for a lamp, as shown and described.

**DESCRIPTION**

FIG. 1 is a front perspective view of a lamp showing my new design;

FIG. 2 is a top plan view thereof;

FIG. 3 is a front elevational view thereof;

FIG. 4 is a first side elevational view thereof;

FIG. 5 is a bottom view thereof opposite the view of FIG. 2;

FIG. 6 is a second side elevational view thereof opposite the view of FIG. 4; and,

FIG. 7 is a rear elevational view thereof, opposite the view of FIG. 3.

The broken lines shown are for illustrative purposes only and form no part of the claimed design.

**1 Claim, 2 Drawing Sheets**

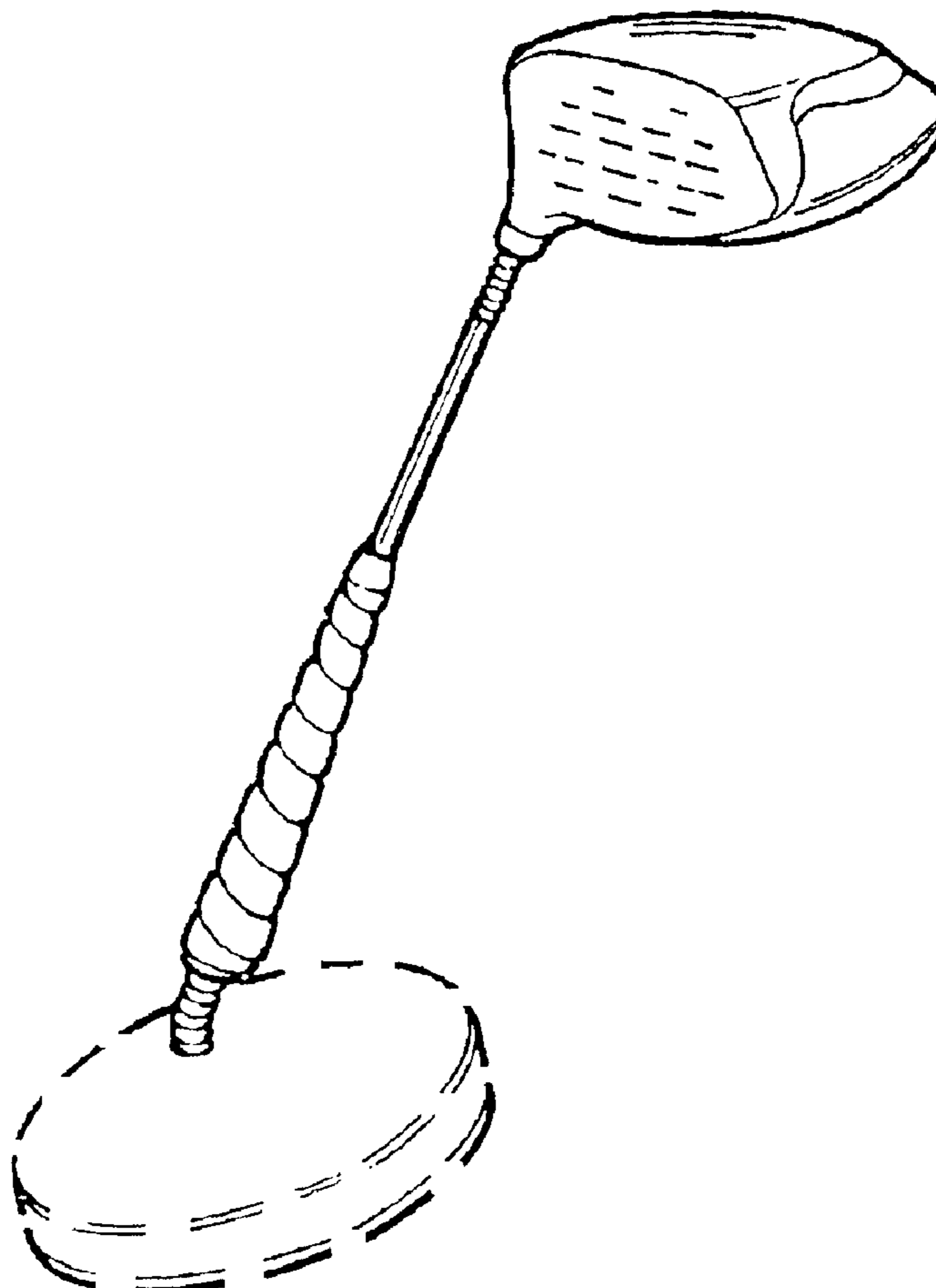

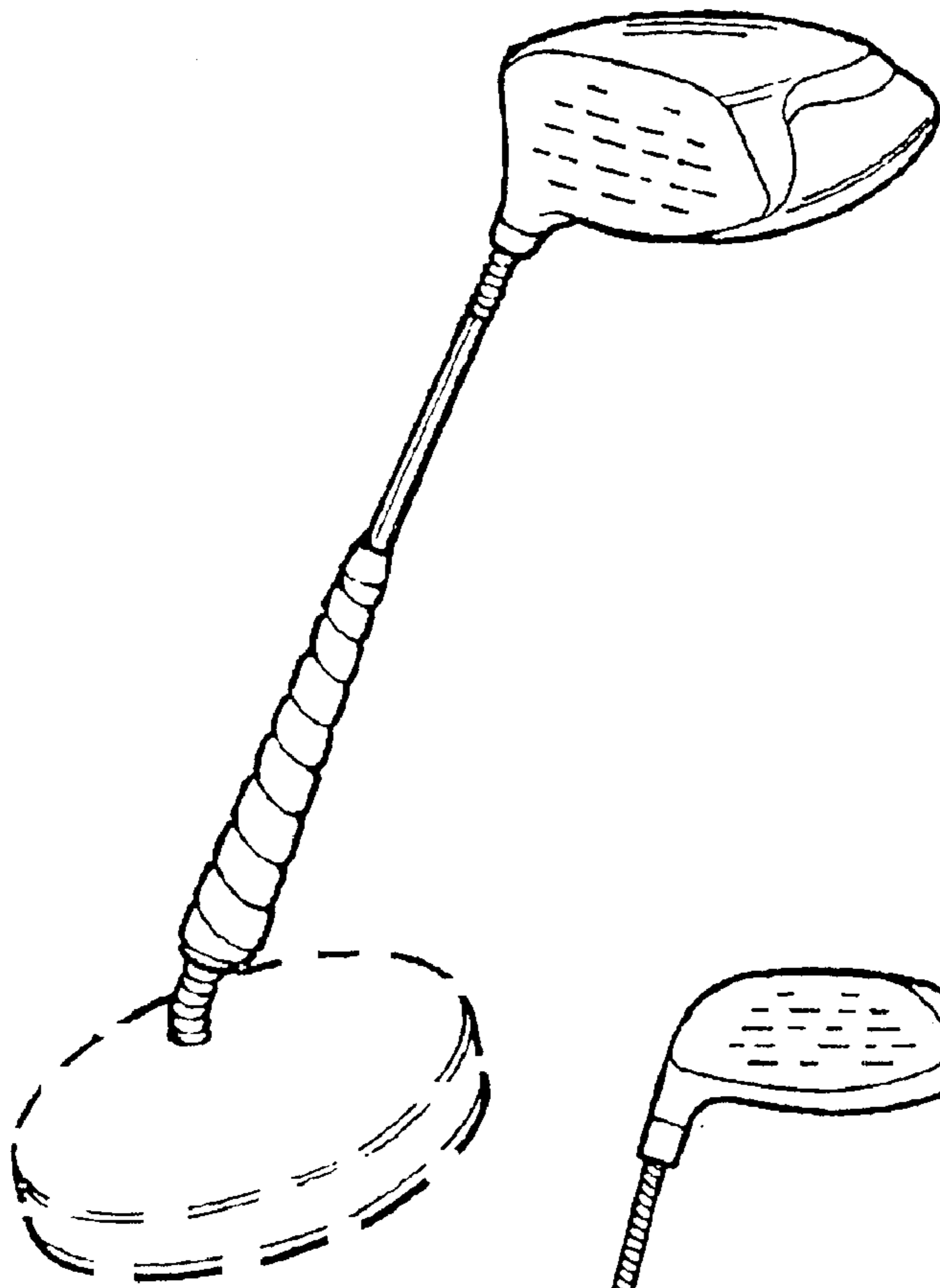

FIG. 1

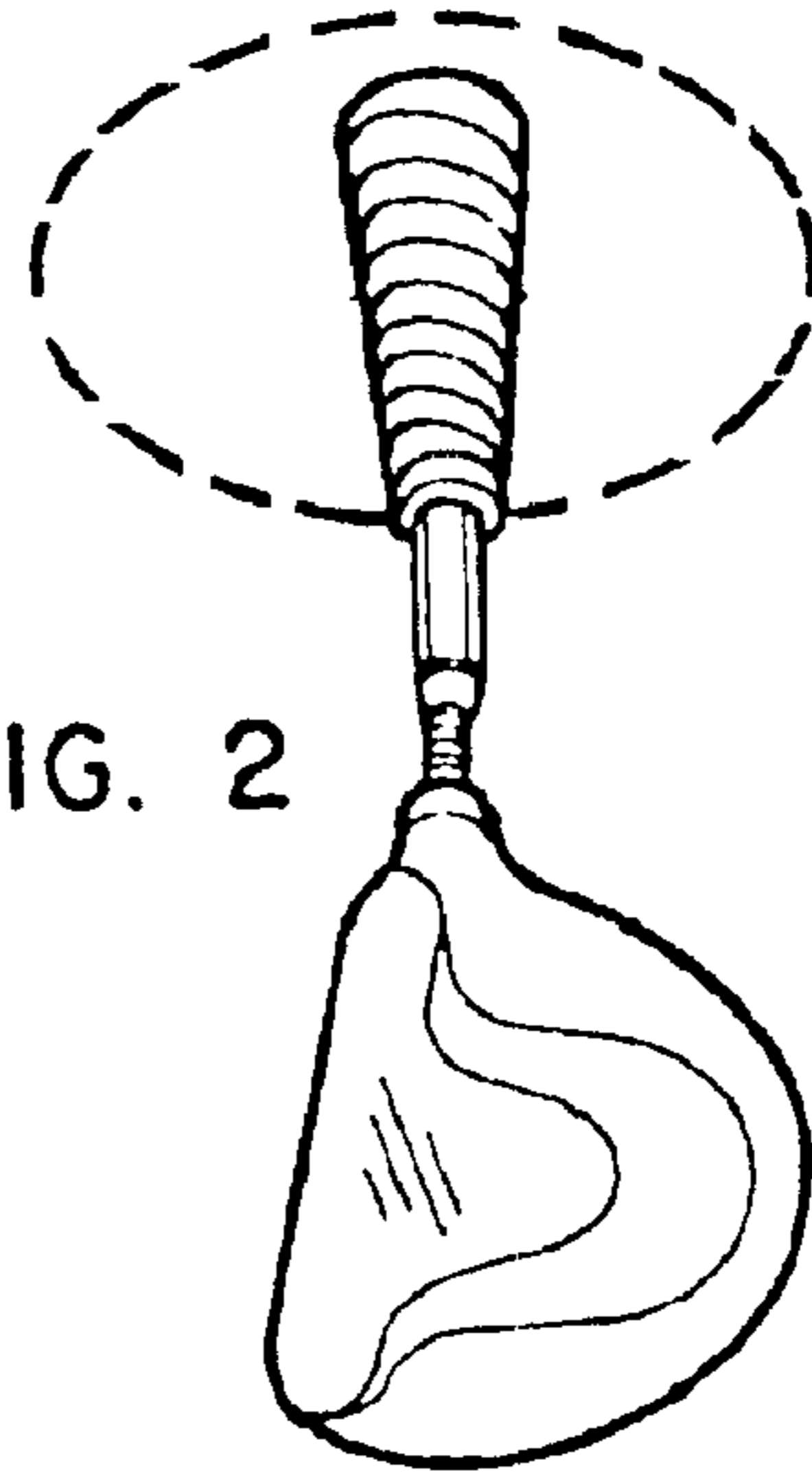

FIG. 2

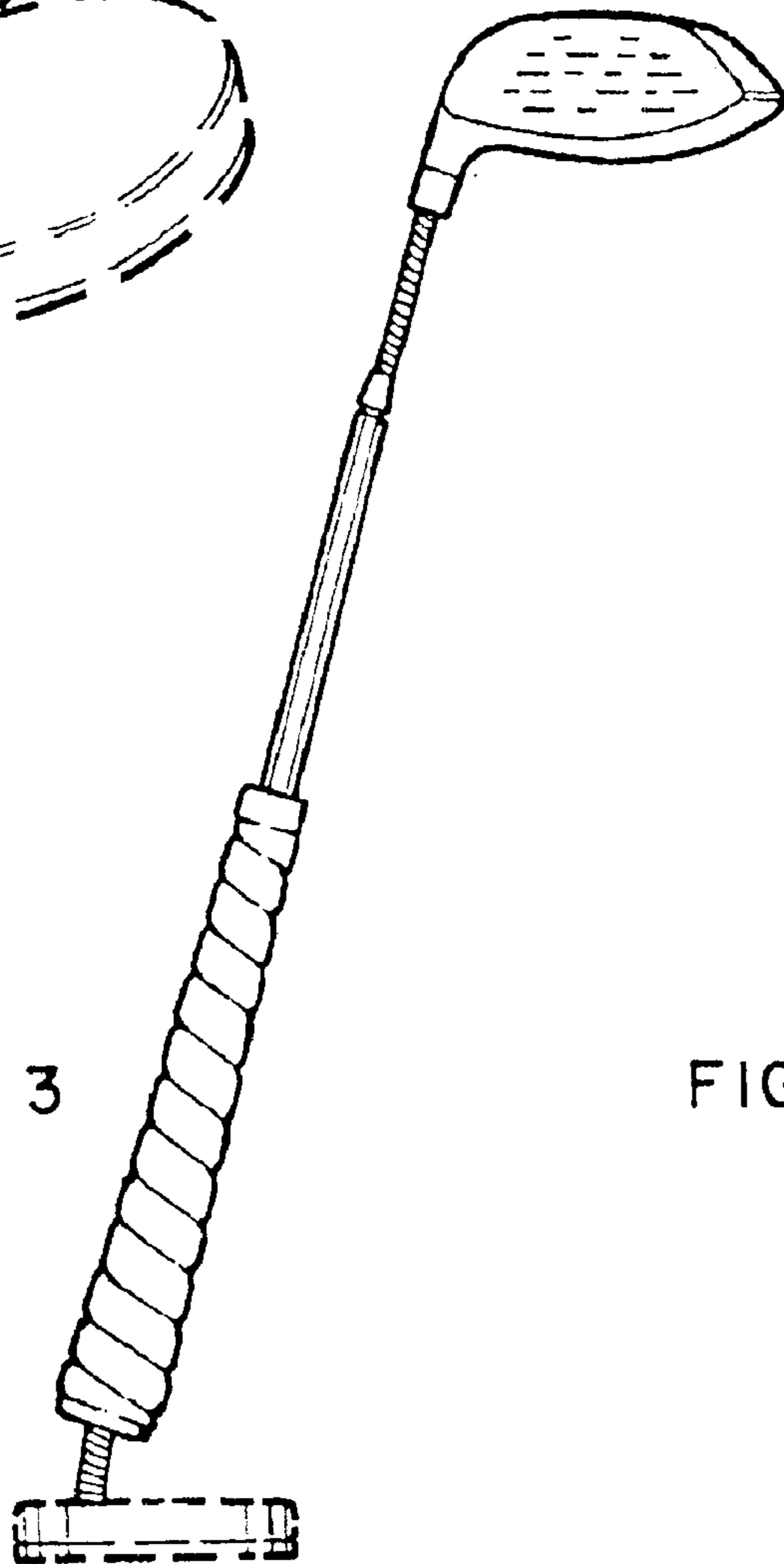

FIG. 3

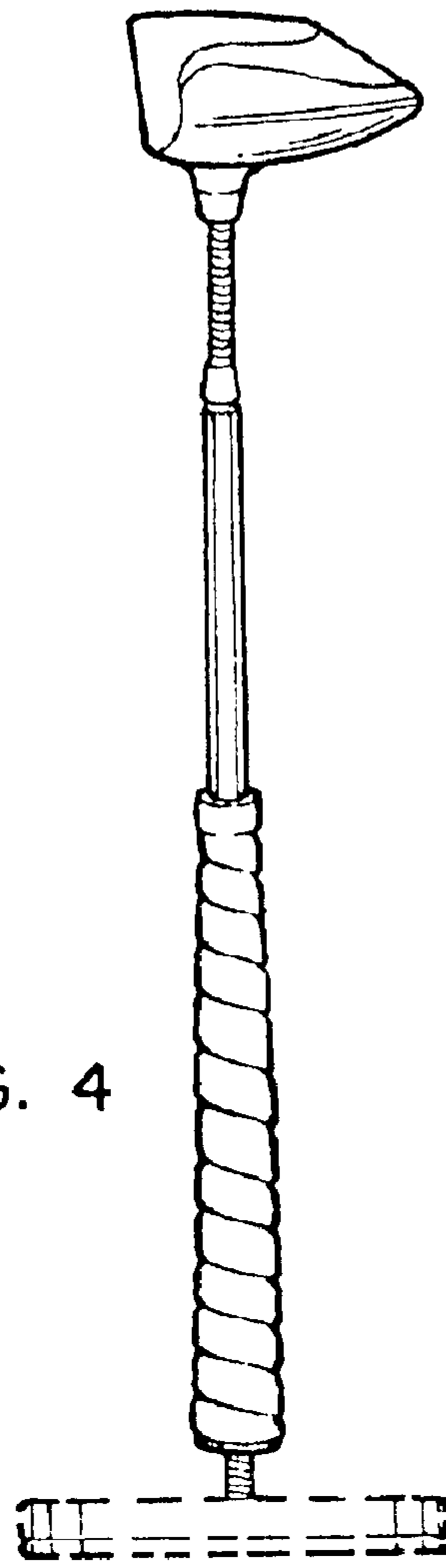

FIG. 4

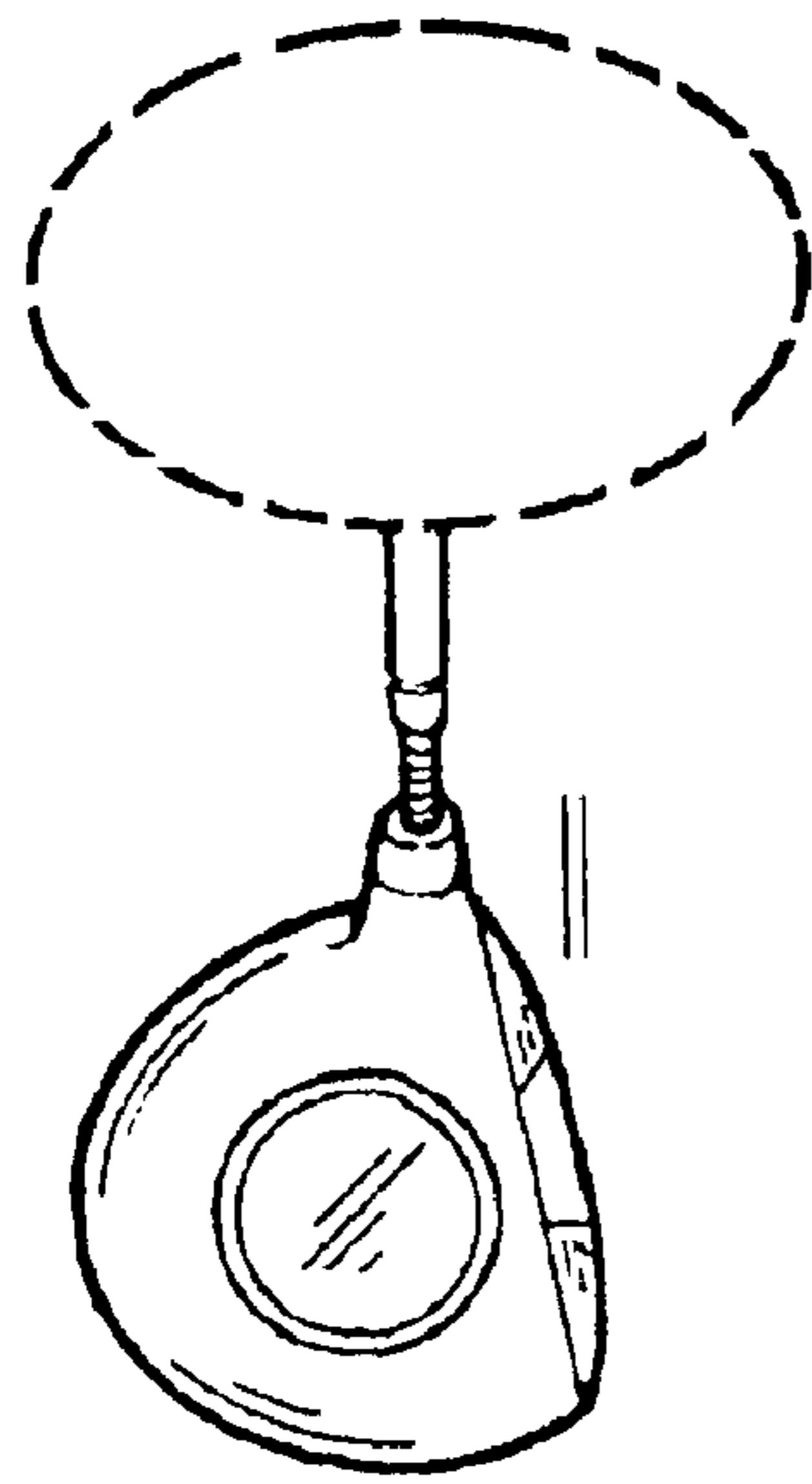

FIG. 5

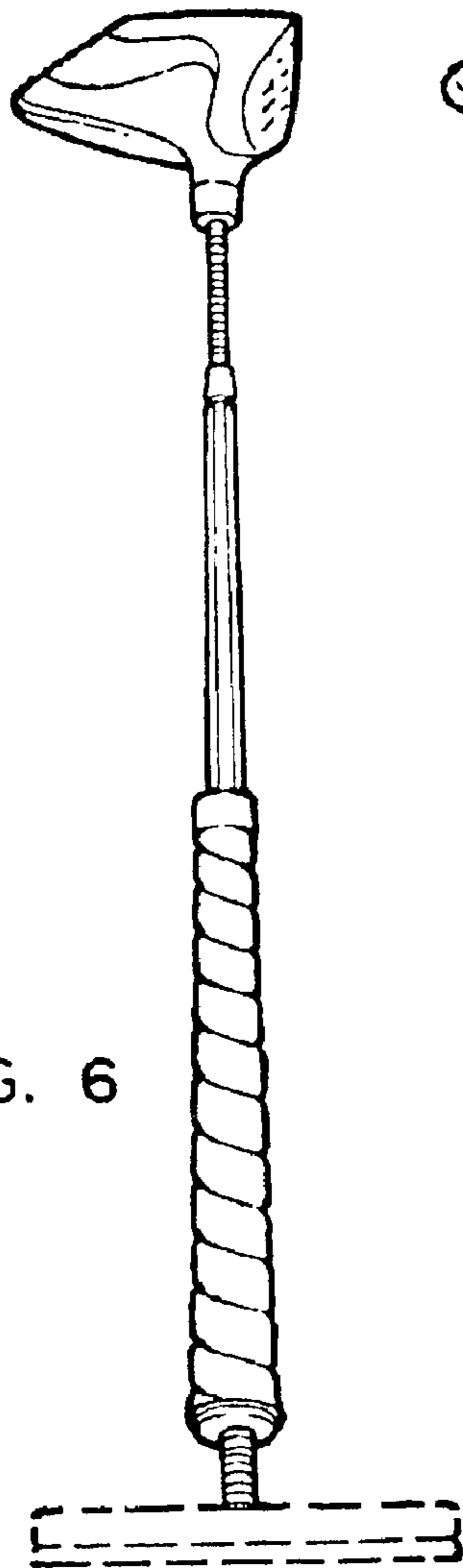

FIG. 6

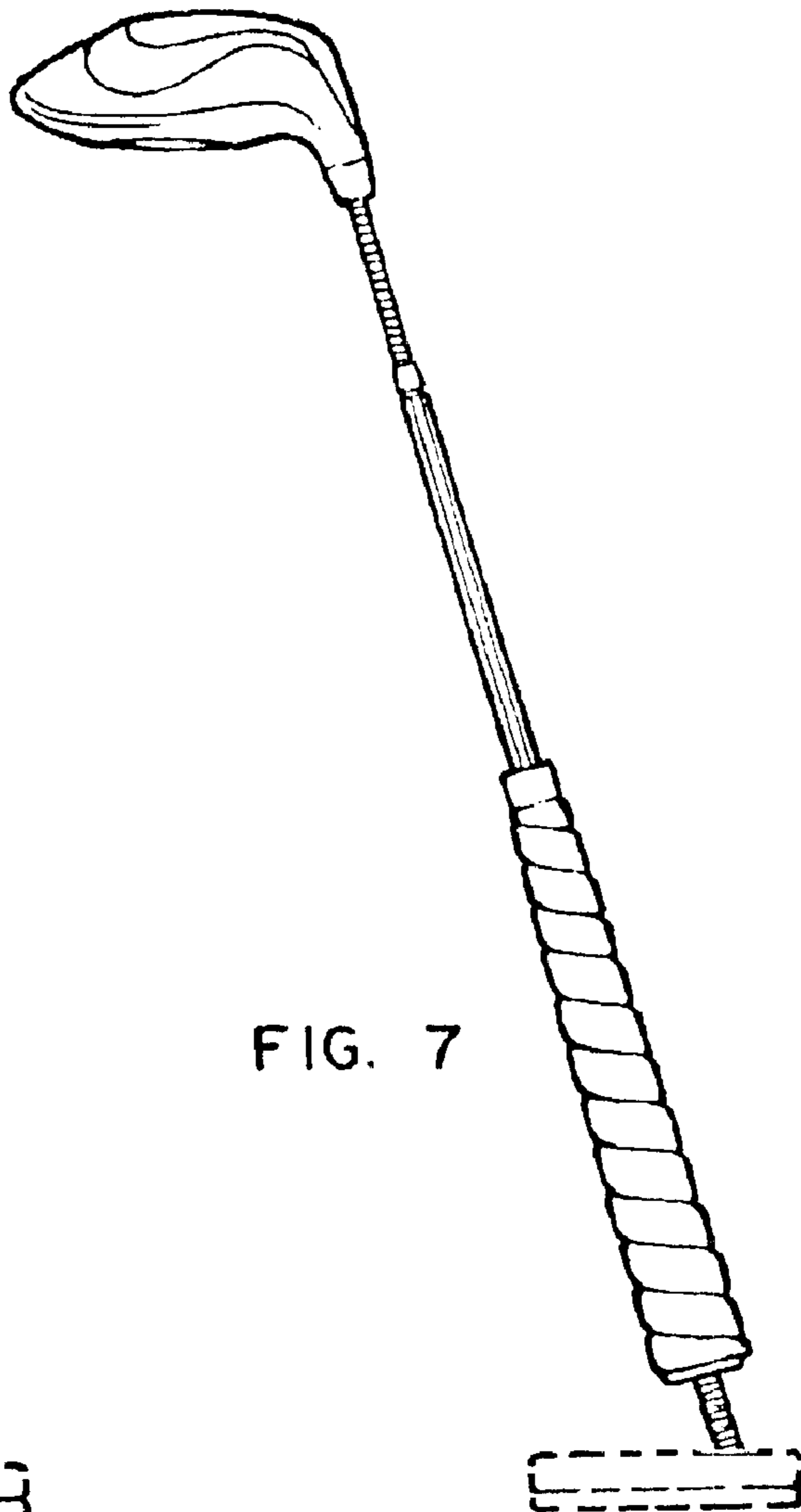

FIG. 7