



US00D508137S

(12) **United States Design Patent**  
**Numata**

(10) **Patent No.:** **US D508,137 S**  
(45) **Date of Patent:** **\*\* Aug. 2, 2005**

(54) **FRONT COMBINATION LAMP FOR  
AUTOMOBILE**

(75) Inventor: **Hideyuki Numata**, Aichi-ken (JP)

(73) Assignee: **Toyota Jidosha Kabushiki Kaisha**,  
Aichi-Ken (JP)

(\*\*) Term: **14 Years**

(21) Appl. No.: **29/210,574**

(22) Filed: **Aug. 4, 2004**

(51) **LOC (8) Cl.** ..... **26-06**

(52) **U.S. Cl.** ..... **D26/28**

(58) **Field of Search** ..... D26/28-36; 362/457-468,  
362/475-478, 485-487

(56) **References Cited**

**U.S. PATENT DOCUMENTS**

D463,049 S	9/2002	Yang	
D464,449 S	10/2002	Yang	
D469,194 S	1/2003	Horowitz	
D473,665 S	4/2003	Tanabe	
D476,430 S	6/2003	Ikuma et al.	
D476,432 S	6/2003	Lin	
D481,144 S	10/2003	Takei	
D482,810 S	11/2003	Wy	
D485,381 S	1/2004	Lung	
D486,595 S	2/2004	Lin	
D489,835 S	* 5/2004	Lin	D26/28
D492,429 S	6/2004	Ueno	
D496,114 S	* 9/2004	Hsu	D26/28
D497,018 S	* 10/2004	Lin	D26/28

**OTHER PUBLICATIONS**

Brochure of HILUX SURF, Oct. 2002, Mfg. Toyota Jidosha Kabushiki Kaisha (3 pages).

IMPORTED CARS GUIDE BOOK, Oct. 29, 2002, Mfg. BMW, Model BMW 330, 318, p. 59.

\* cited by examiner

*Primary Examiner*—Marcus A. Jackson

(74) *Attorney, Agent, or Firm*—Finnegan, Henderson, Farabow, Garrett & Dunner, LLP

(57) **CLAIM**

The ornamental design for a front combination lamp for automobile, as shown and described.

**DESCRIPTION**

FIG. 1 is a right-front, perspective view of a front combination lamp for automobile of my new design;

FIG. 2 is a front view of my new design;

FIG. 3 is a rear view of my new design;

FIG. 4 is a top view of my new design;

FIG. 5 is a bottom view of my new design;

FIG. 6 is a left-side view of my new design;

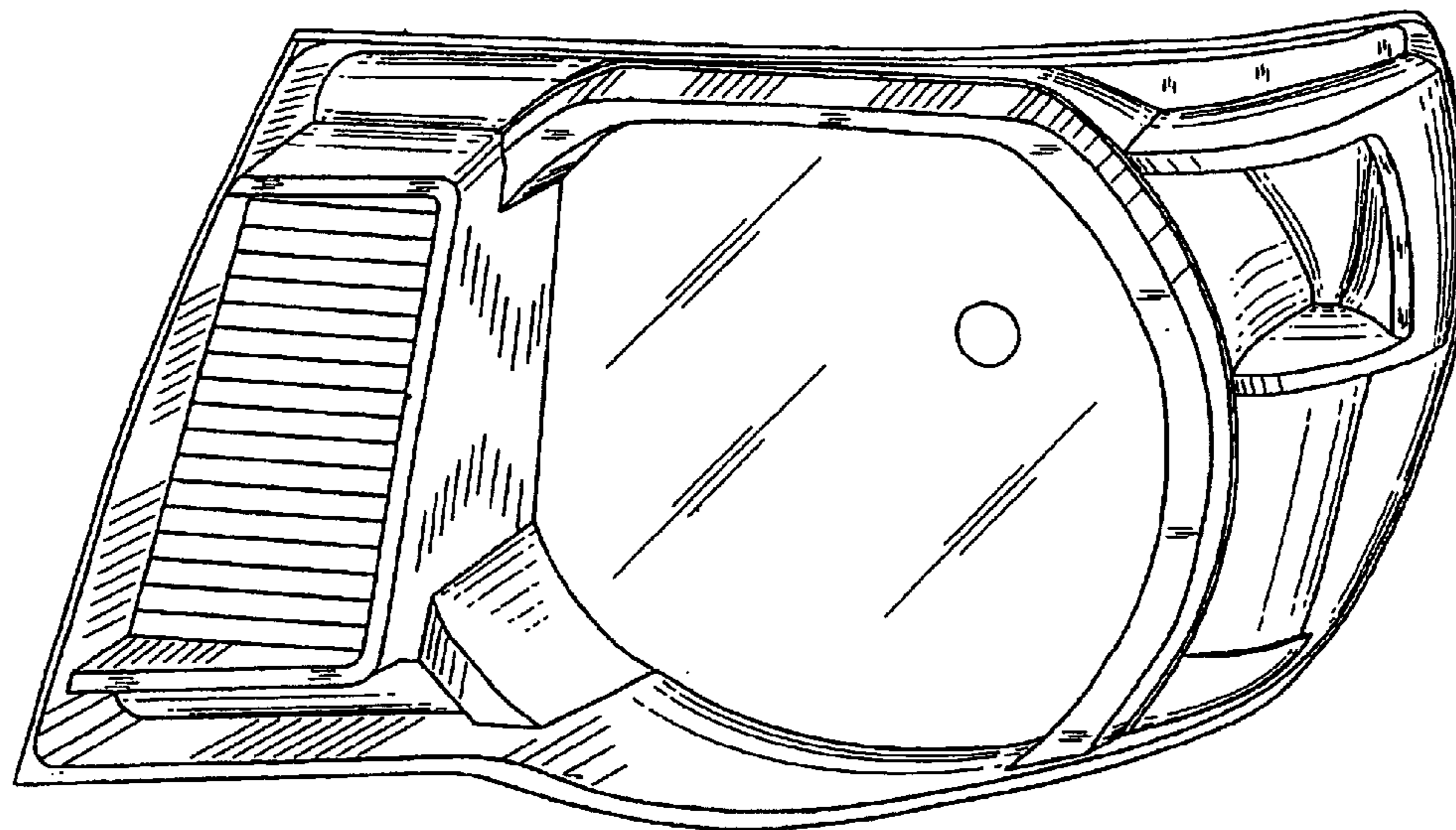
FIG. 7 is a right-side view of my new design;

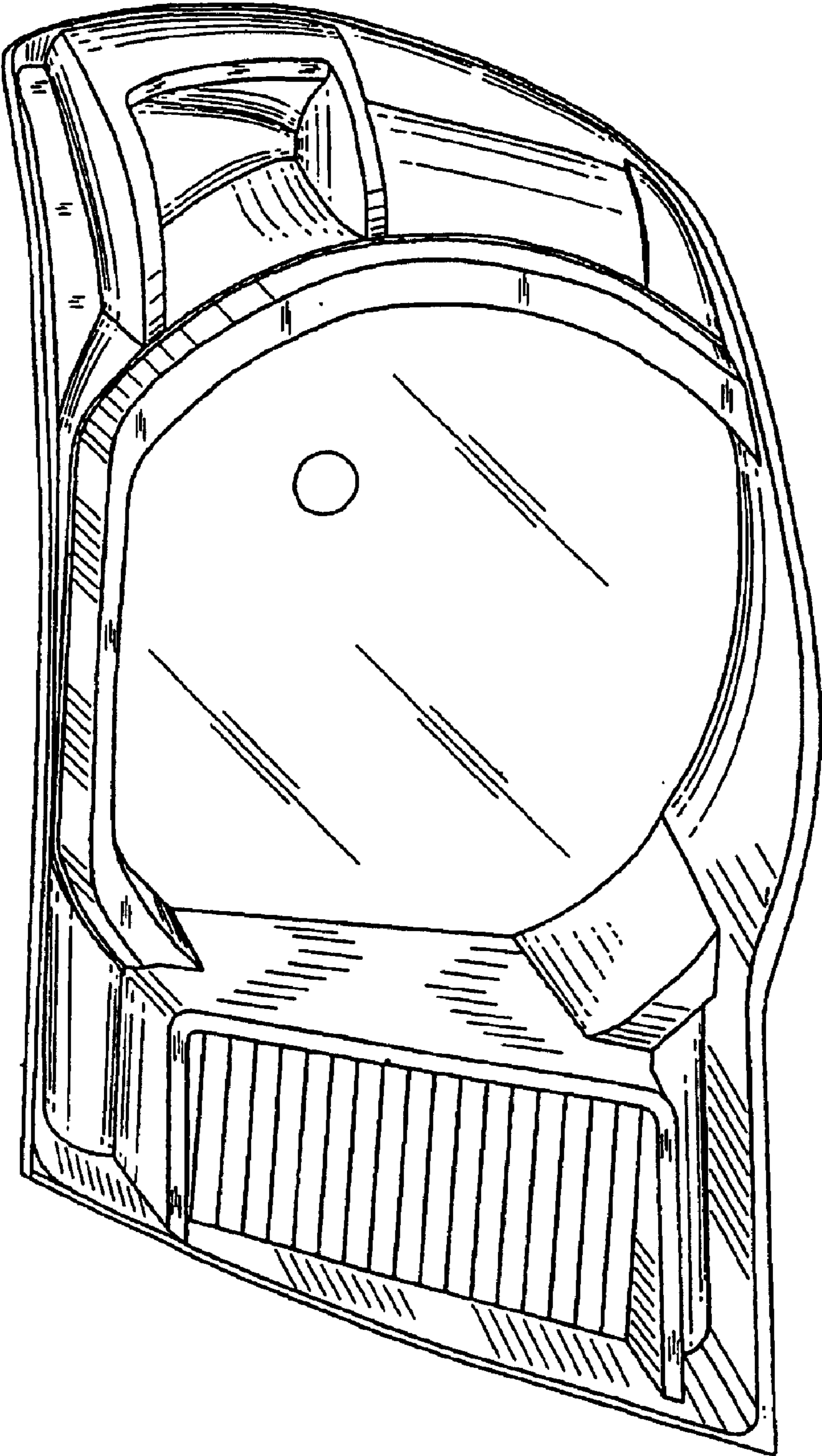
FIG. 8 is a cross-sectional view of my new design taken along the line 8—8 in FIG. 2, showing the profile of that portion of the design; and,

FIG. 9 is a cross-sectional view of my new design taken along the line 9—9 in FIG. 2, showing the profile of that portion of the design.

My design includes the mirror image of the embodiment depicted.

**1 Claim, 9 Drawing Sheets**





**FIG. 1**

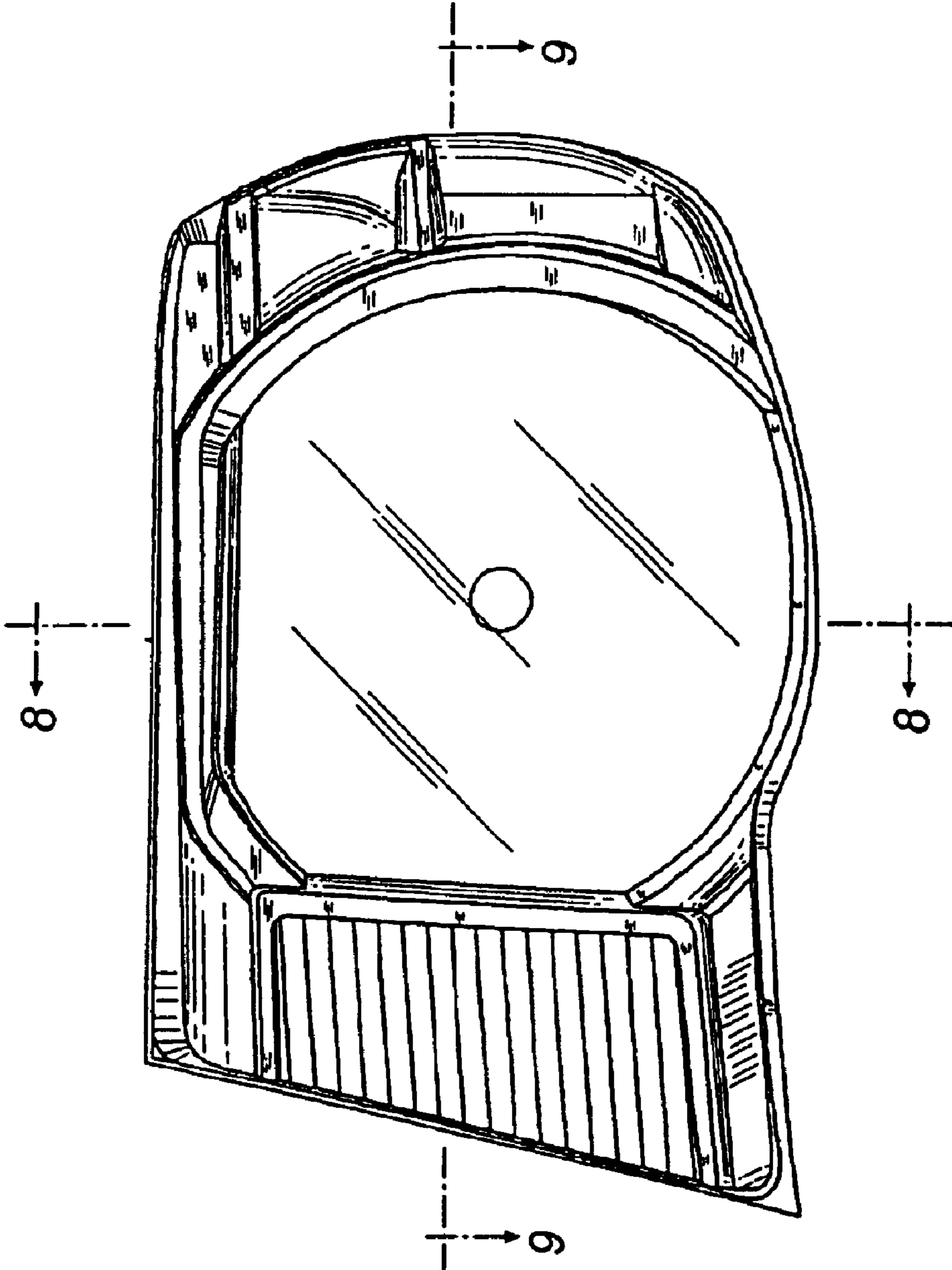
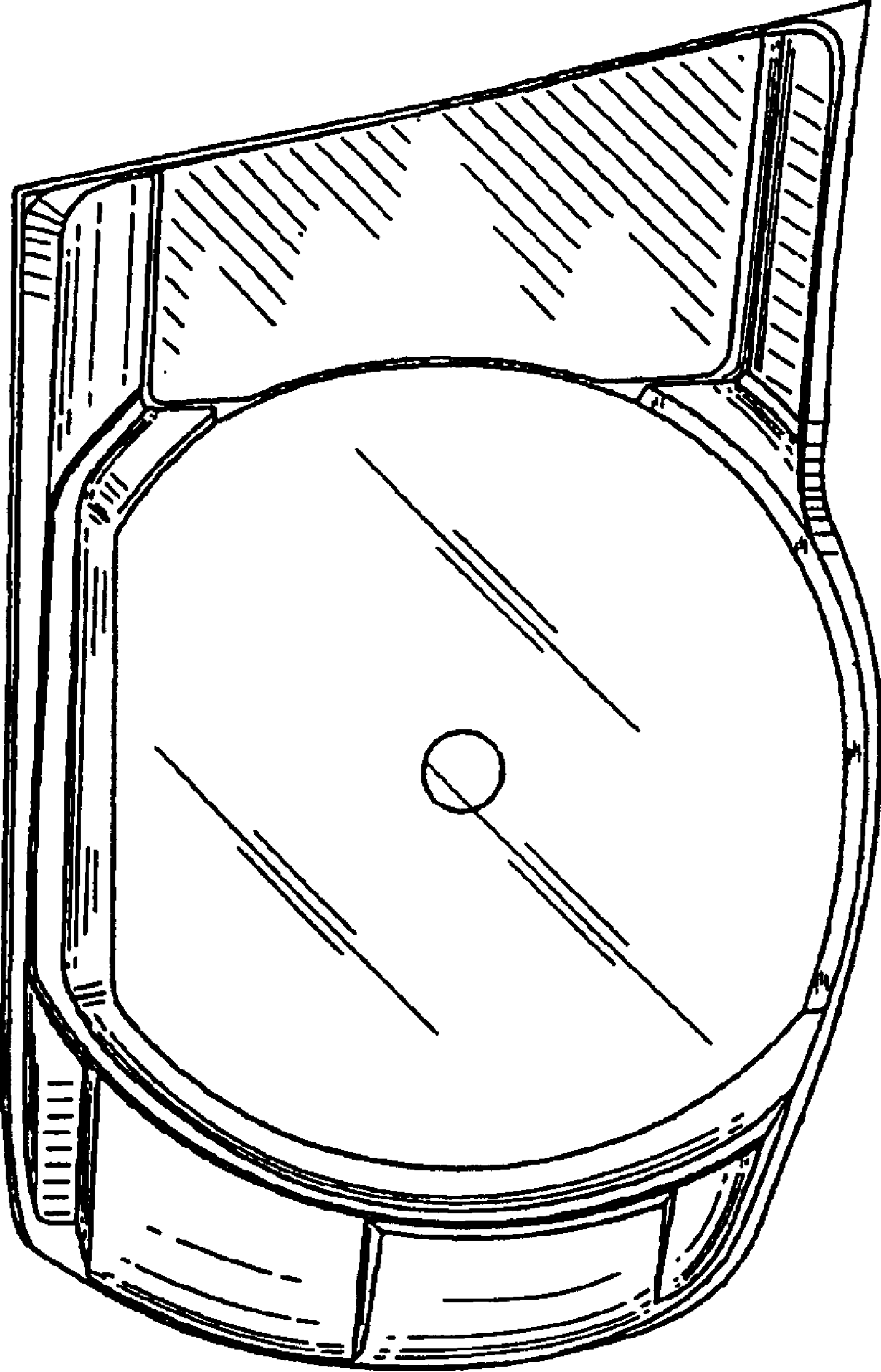
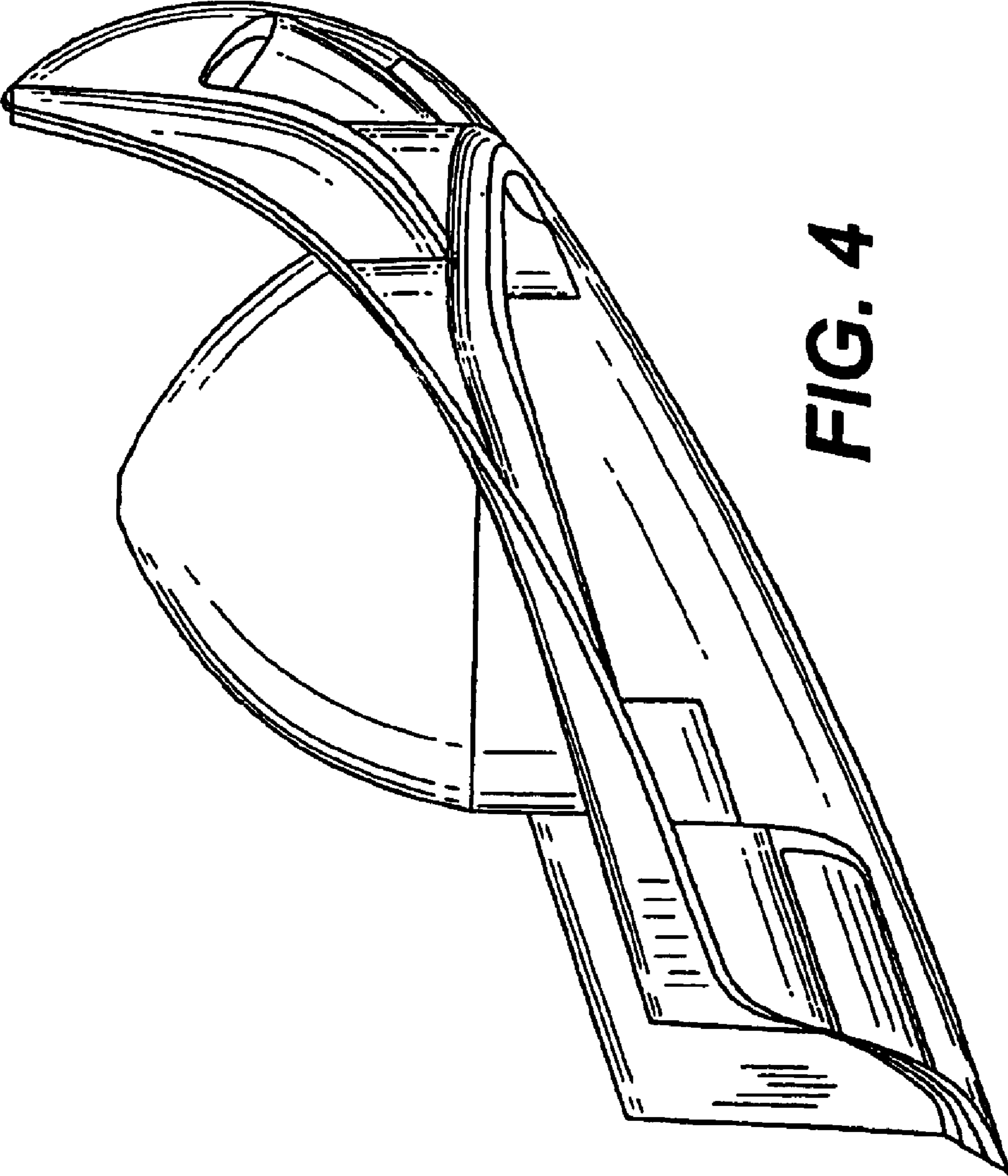


FIG. 2

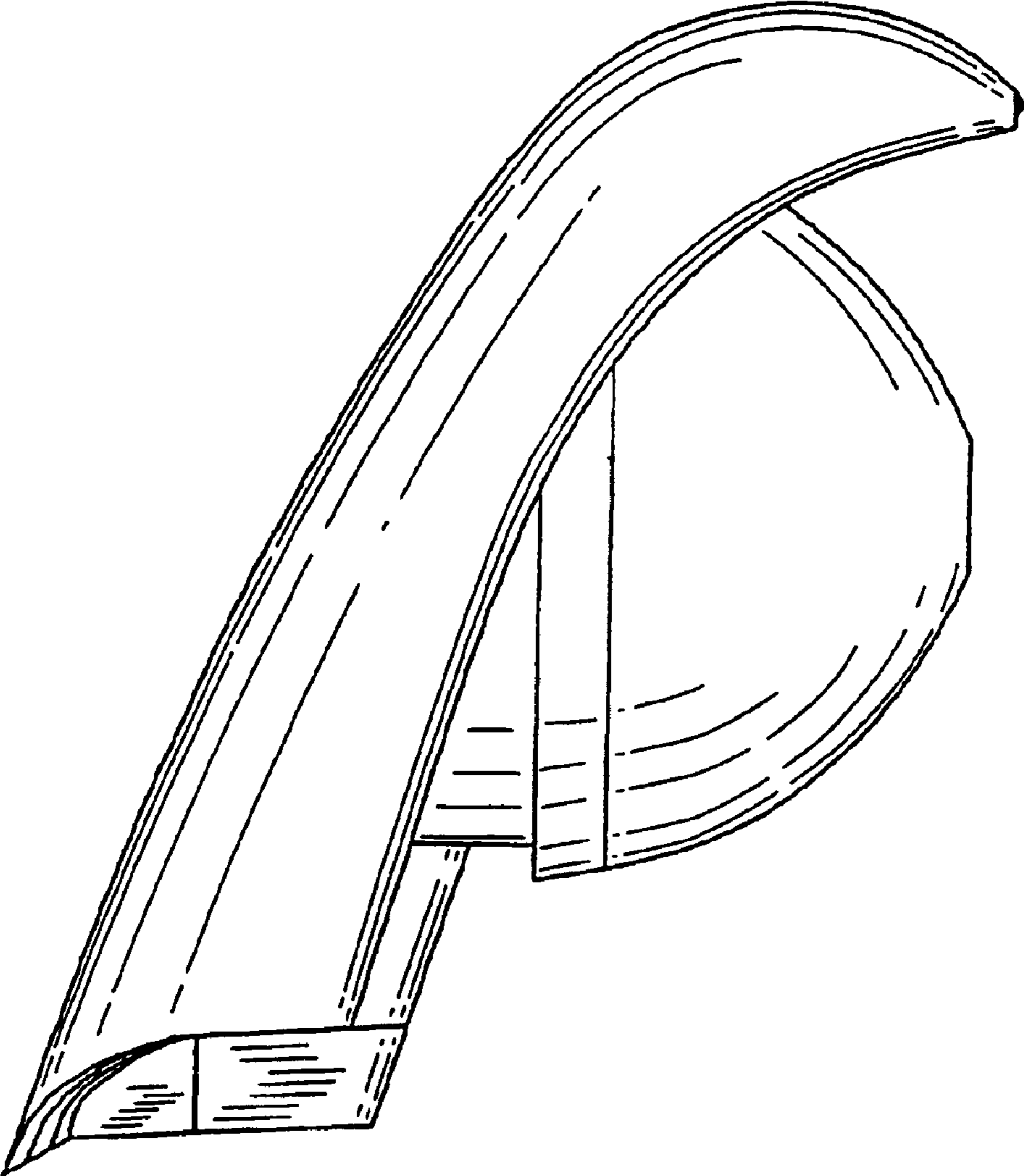


**FIG. 3**

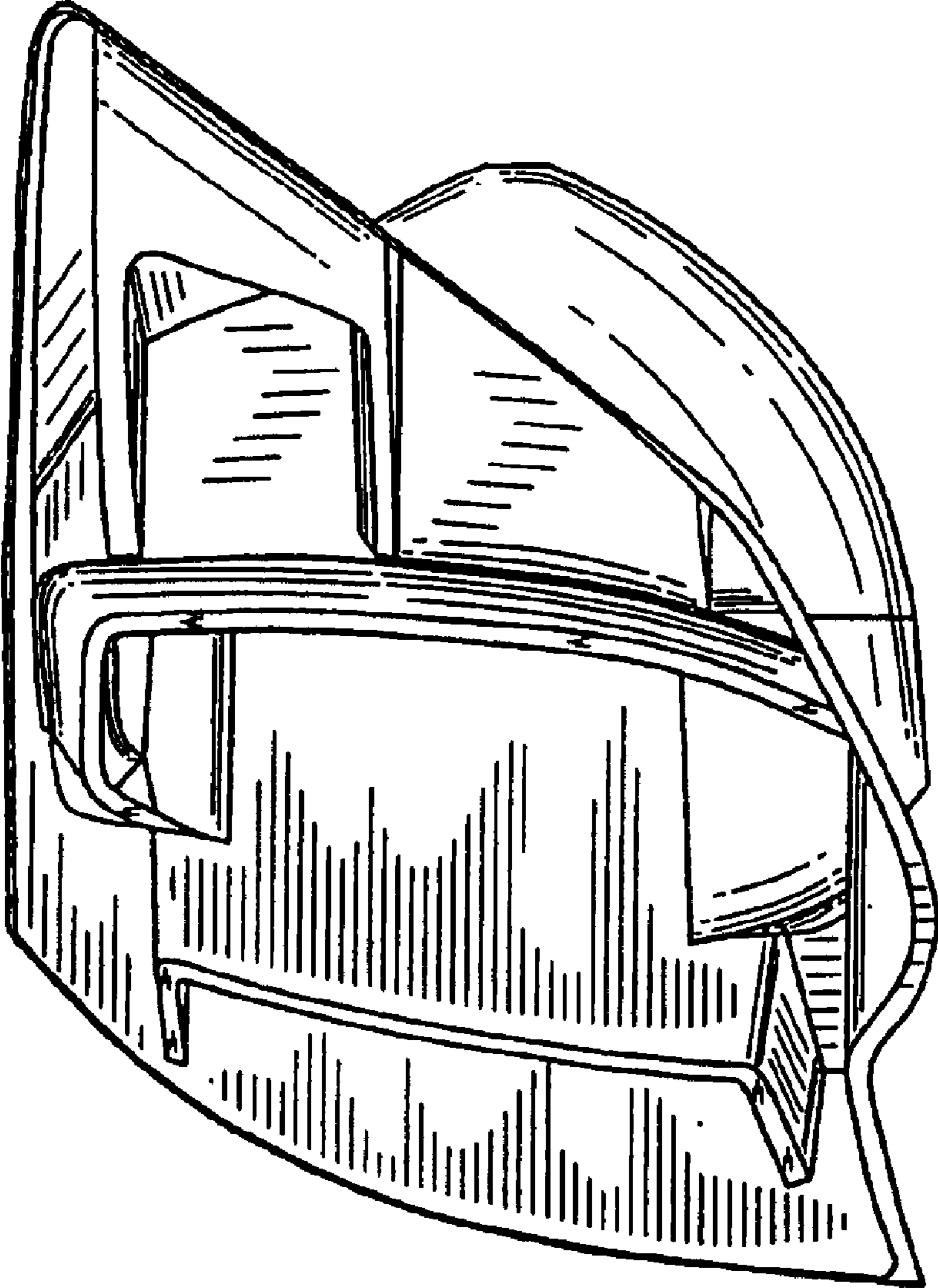




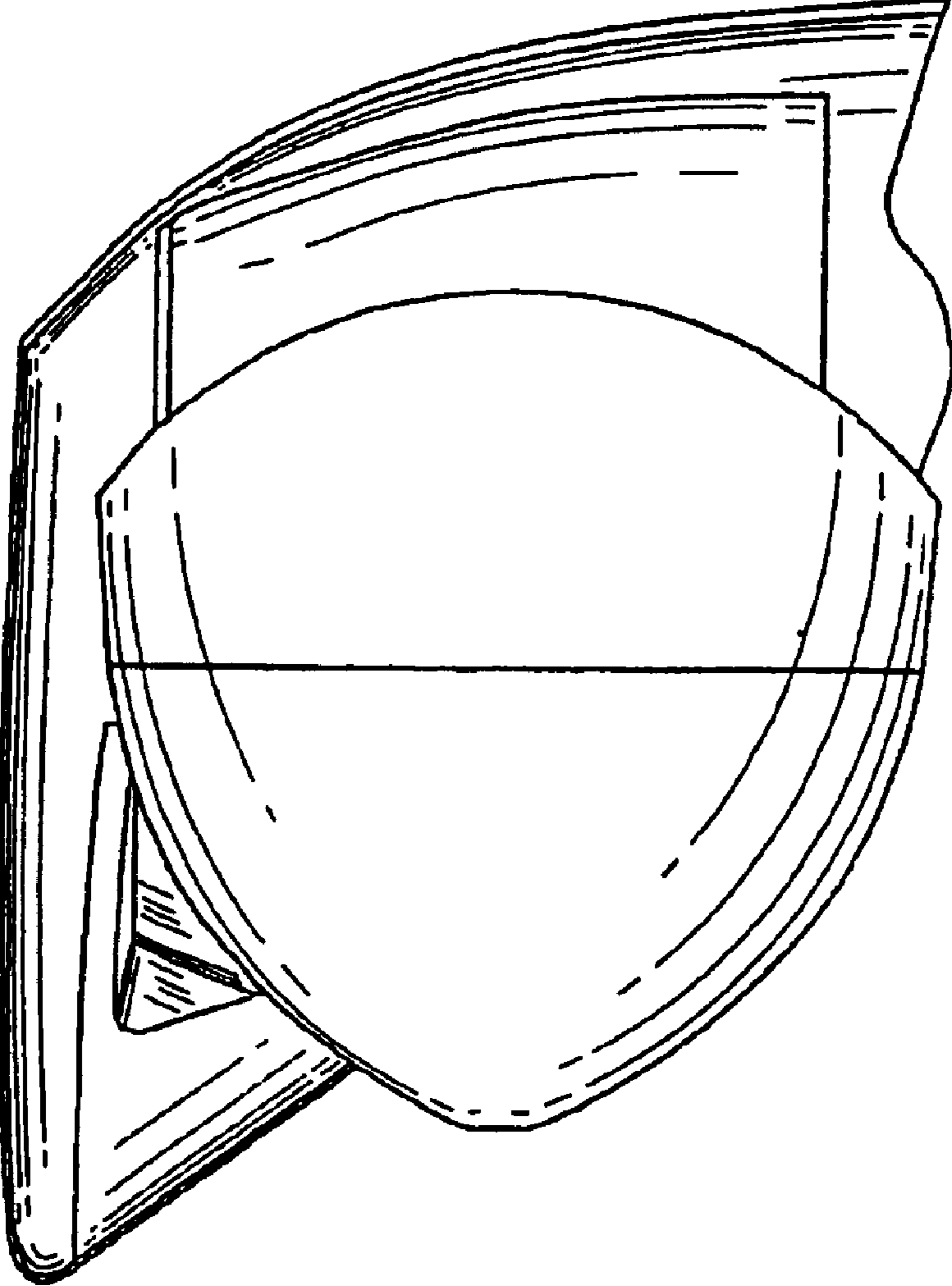
**FIG. 4**



**FIG. 5**

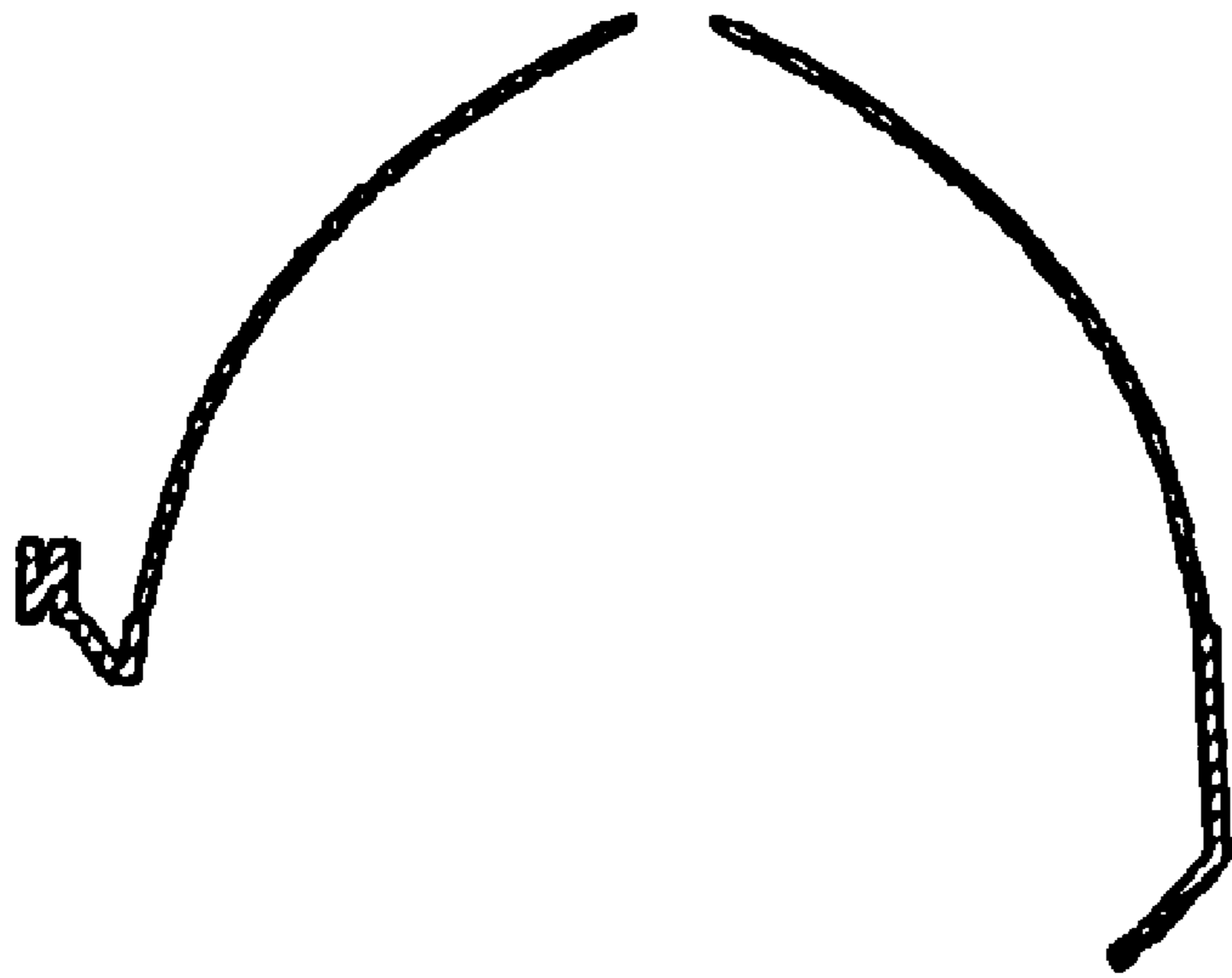


**FIG. 6**

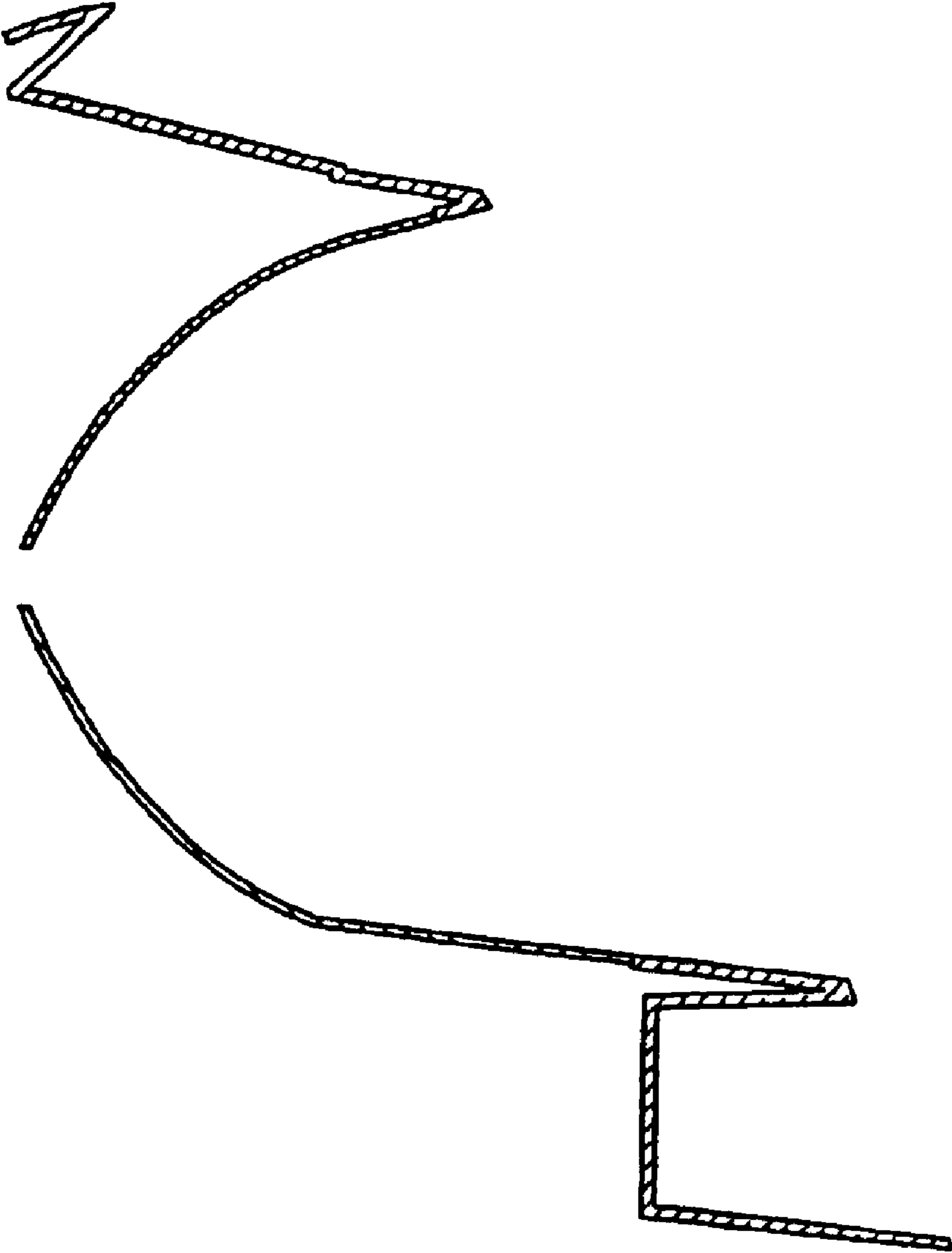


**FIG. 7**





**FIG. 8**



**FIG. 9**