

US00D508072S

(12) **United States Design Patent** (10) **Patent No.:** **US D508,072 S**
Kida et al. (45) **Date of Patent:** **** Aug. 2, 2005**

(54) **STAMP**

(75) Inventors: **Masaki Kida**, Setagaya-ku (JP);
Motohide Imaizumi, Setagaya-ku (JP)

(73) Assignee: **Shachihata Inc.**, Aichi (JP)

(**) Term: **14 Years**

(21) Appl. No.: **29/209,581**

(22) Filed: **Jul. 19, 2004**

(30) **Foreign Application Priority Data**

Jan. 22, 2004 (JP) D2004-001400

(51) **LOC (8) Cl.** **19-02**

(52) **U.S. Cl.** **D18/15**

(58) **Field of Search** D18/15-18, 50;
101/333-334, 327, 405, 406, 328, 352.07;
118/264, 268

(56) **References Cited**

U.S. PATENT DOCUMENTS

- D231,028 S * 3/1974 Funahshi D18/15
- D326,276 S * 5/1992 Mehaffey et al. D18/15
- D378,597 S * 3/1997 Harden D18/15
- D391,983 S * 3/1998 Yamaguchi D18/15
- D412,181 S * 7/1999 Harden D18/15
- D422,017 S * 3/2000 Harden D18/15
- D446,805 S * 8/2001 Suto D18/15
- D477,628 S * 7/2003 Zambelli et al. D18/15
- D478,930 S * 8/2003 Zambelli et al. D18/15
- D493,192 S * 7/2004 Sculler et al. D18/15
- D495,732 S * 9/2004 Treml D18/15
- D495,733 S * 9/2004 Sculler D18/18
- D497,936 S * 11/2004 Kida et al. D18/15

FOREIGN PATENT DOCUMENTS

GB 2034926 * 2/1994

GB 2067449 * 11/1997

* cited by examiner

Primary Examiner—Charles A. Rademaker

(74) *Attorney, Agent, or Firm*—Jacobson Holman PLLC

(57) **CLAIM**

The ornamental design for a stamp, as shown and described.

DESCRIPTION

FIG. 1 is a front elevation of a stamp showing our new design;

FIG. 2 is a rear elevation thereof;

FIG. 3 is a right side elevation thereof;

FIG. 4 is a left side elevation thereof;

FIG. 5 is a top plan elevation thereof;

FIG. 6 is a bottom plan view thereof;

FIG. 7 is a cross-sectional view taken along line A—A in FIG. 1;

FIG. 8 is a cross-sectional view taken along line B—B in FIG. 3;

FIG. 9 is a front elevation of the stamp body with the cap omitted for ease of illustration;

FIG. 10 is a rear elevation thereof;

FIG. 11 is a right side elevation thereof;

FIG. 12 is a left side elevation thereof;

FIG. 13 is a top plan view thereof;

FIG. 14 is a bottom plan view thereof;

FIG. 15 is a front elevation of the cap member with the stamp body omitted for ease of illustration;

FIG. 16 is a rear elevation thereof;

FIG. 17 is a right side elevation thereof;

FIG. 18 is a left side elevation thereof;

FIG. 19 is a top plan view thereof; and,

FIG. 20 is a bottom plan view thereof.

1 Claim, 5 Drawing Sheets

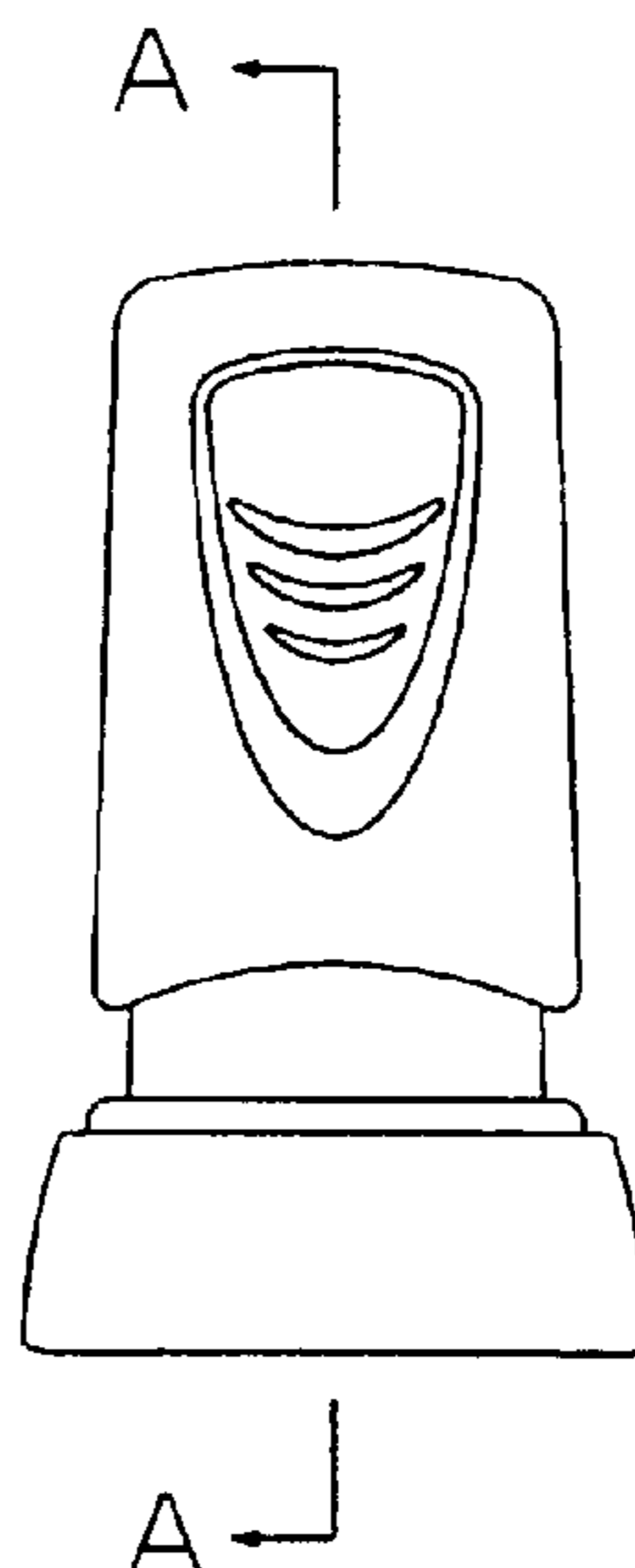

FIG.1

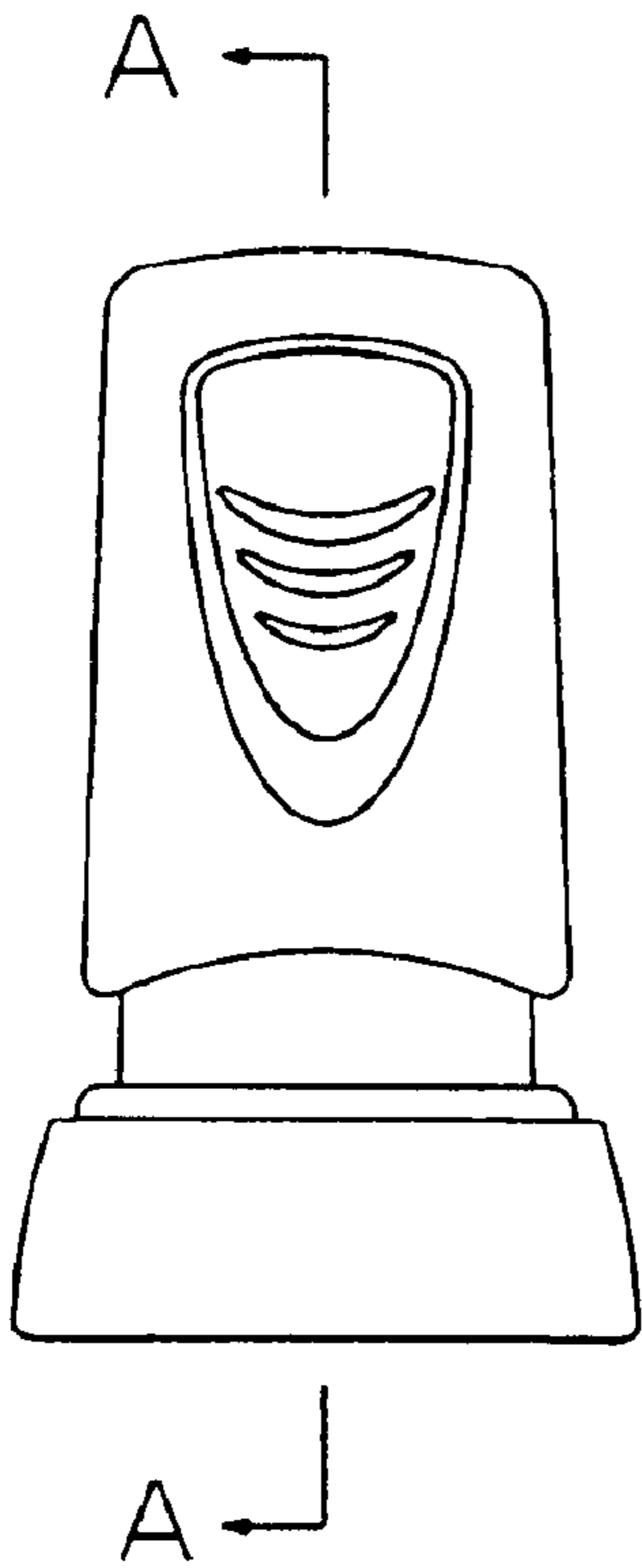

FIG.3

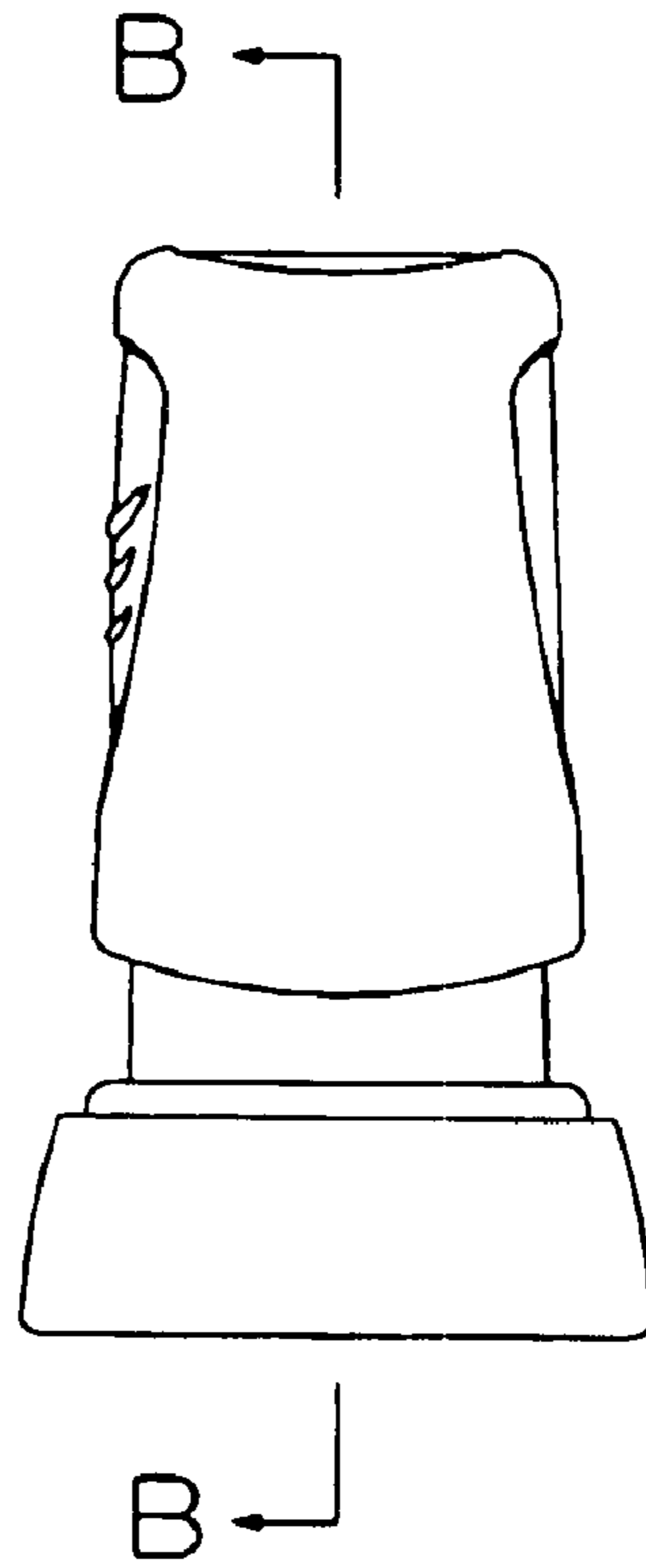

FIG.2

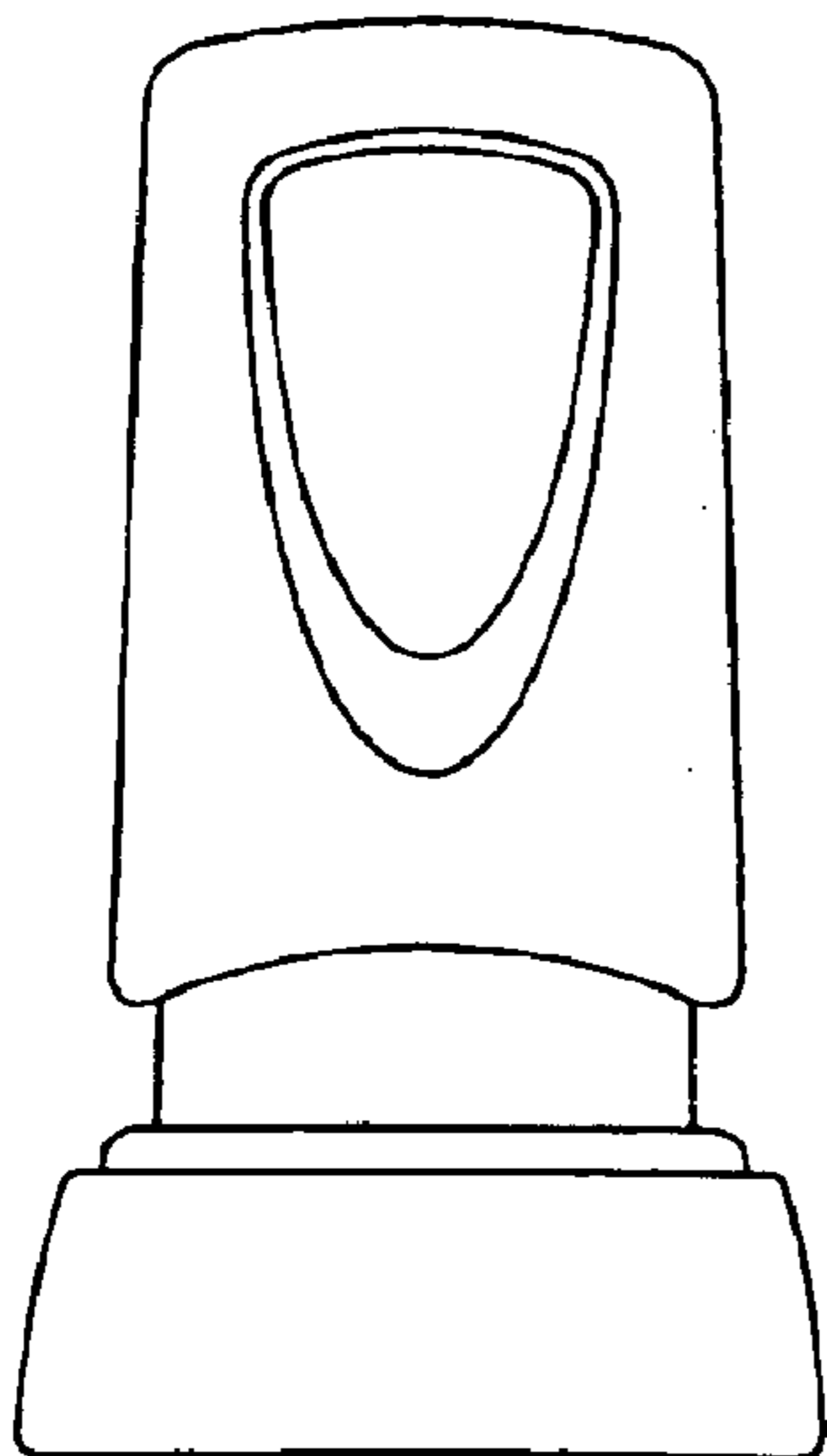

FIG.4

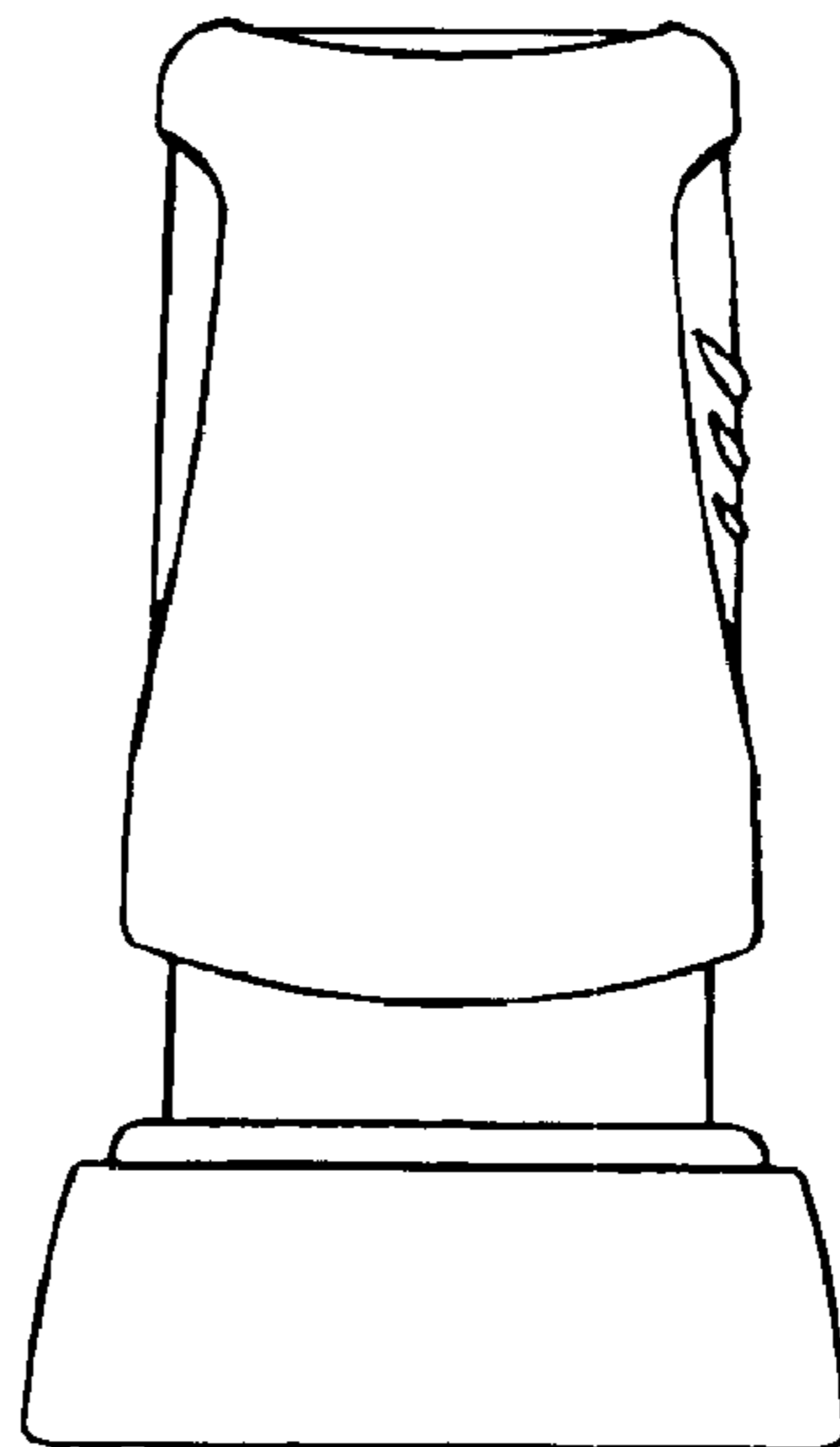

FIG.5

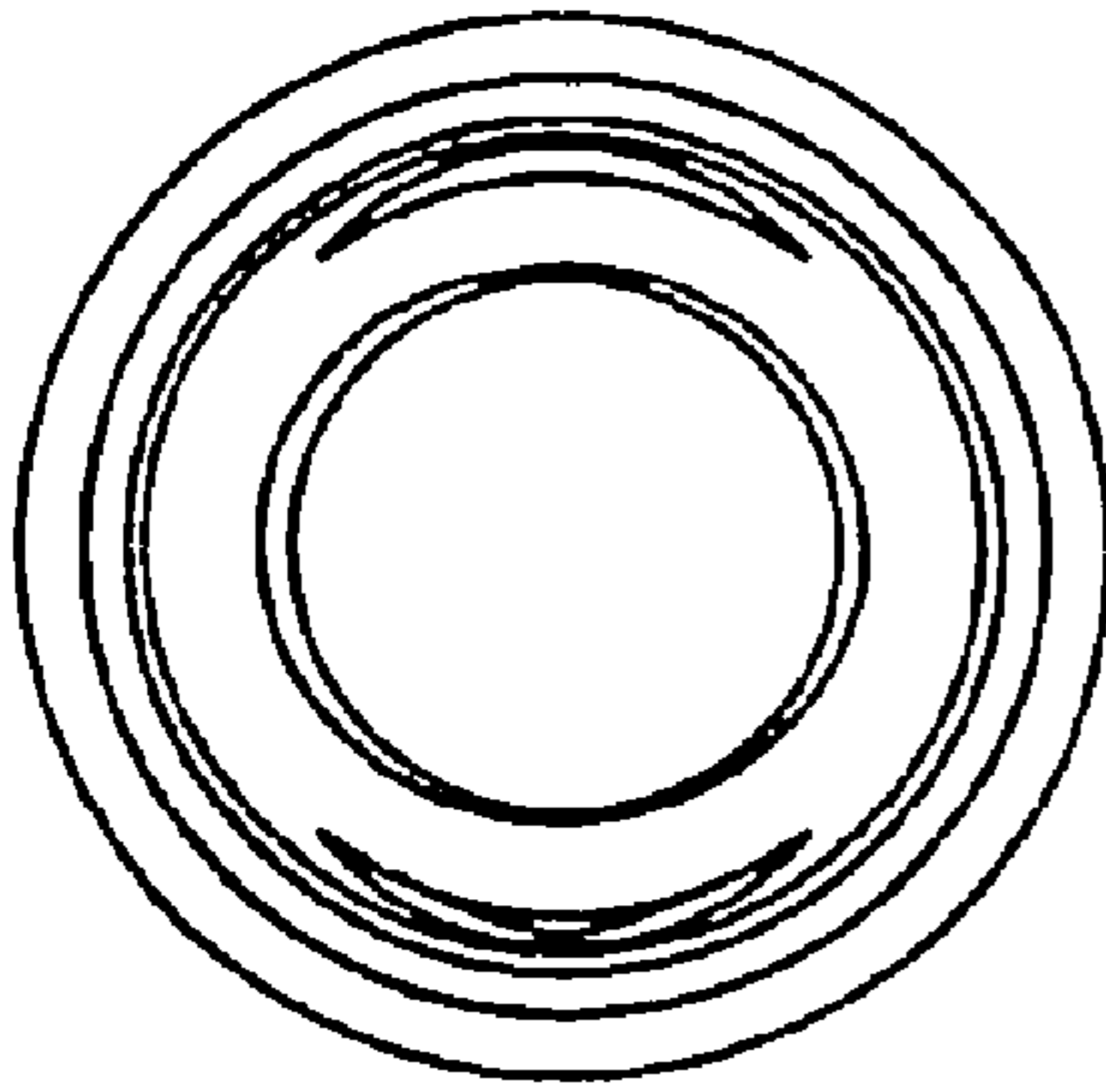

FIG.6

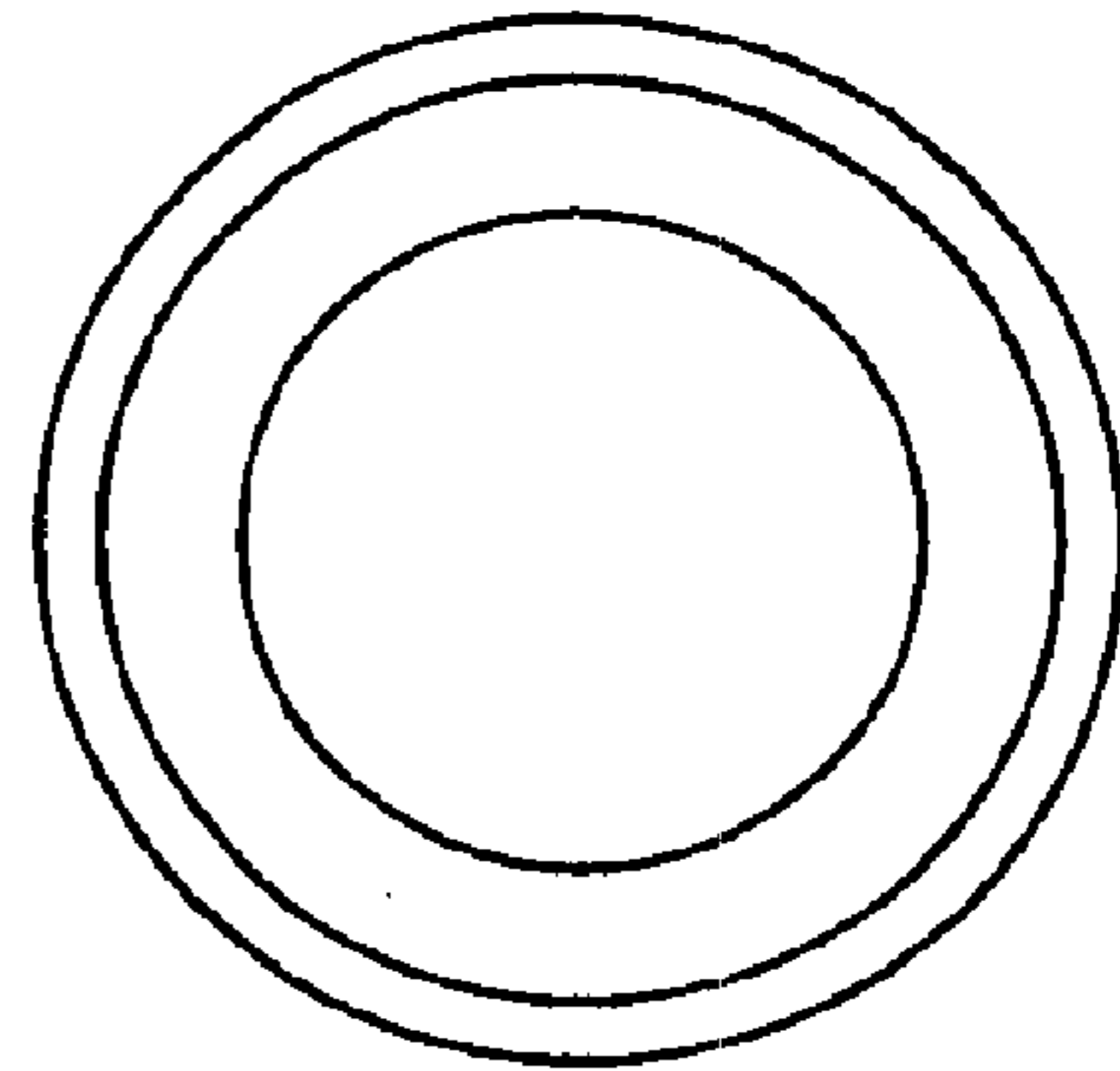

FIG.7

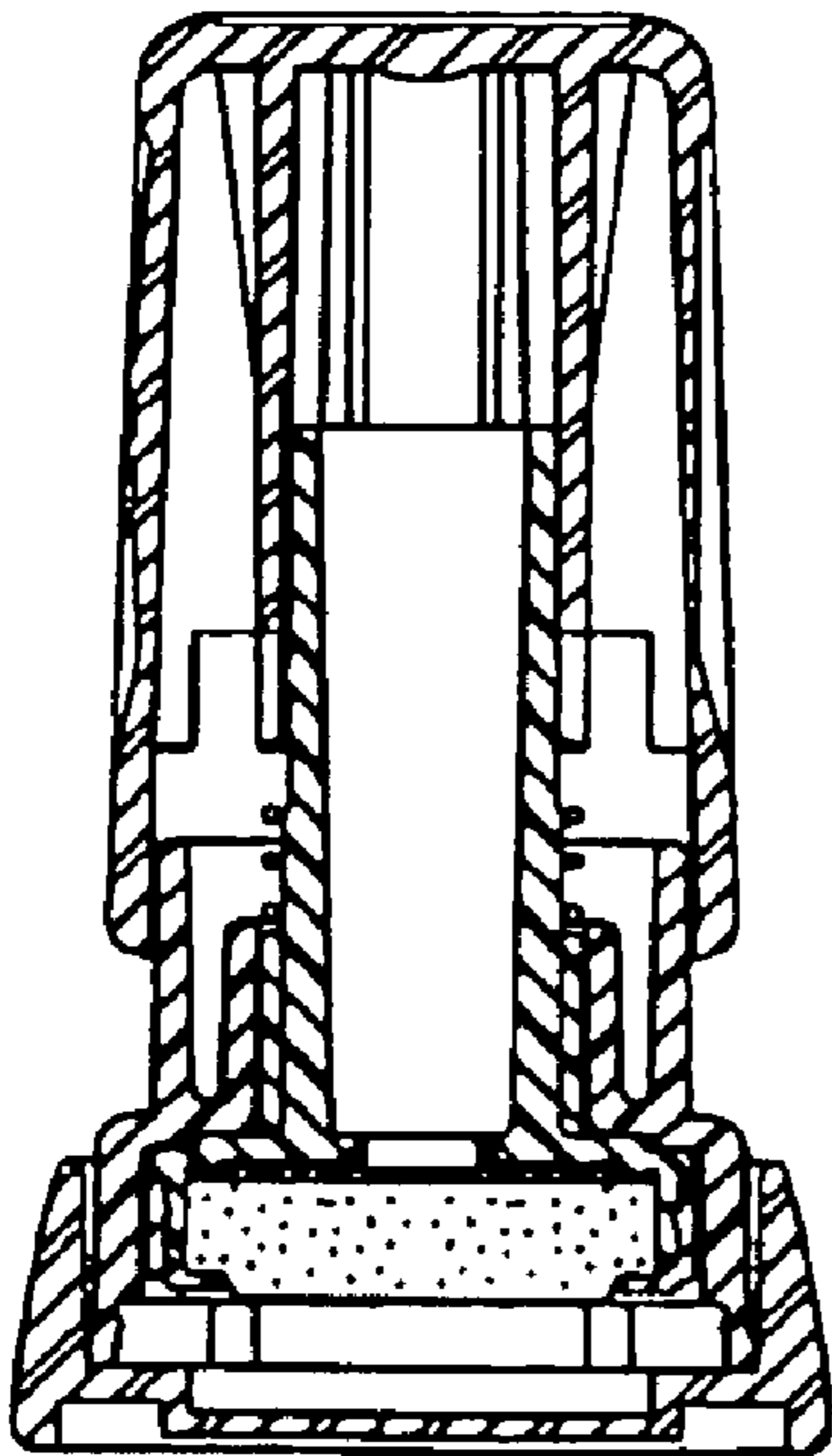

FIG.8

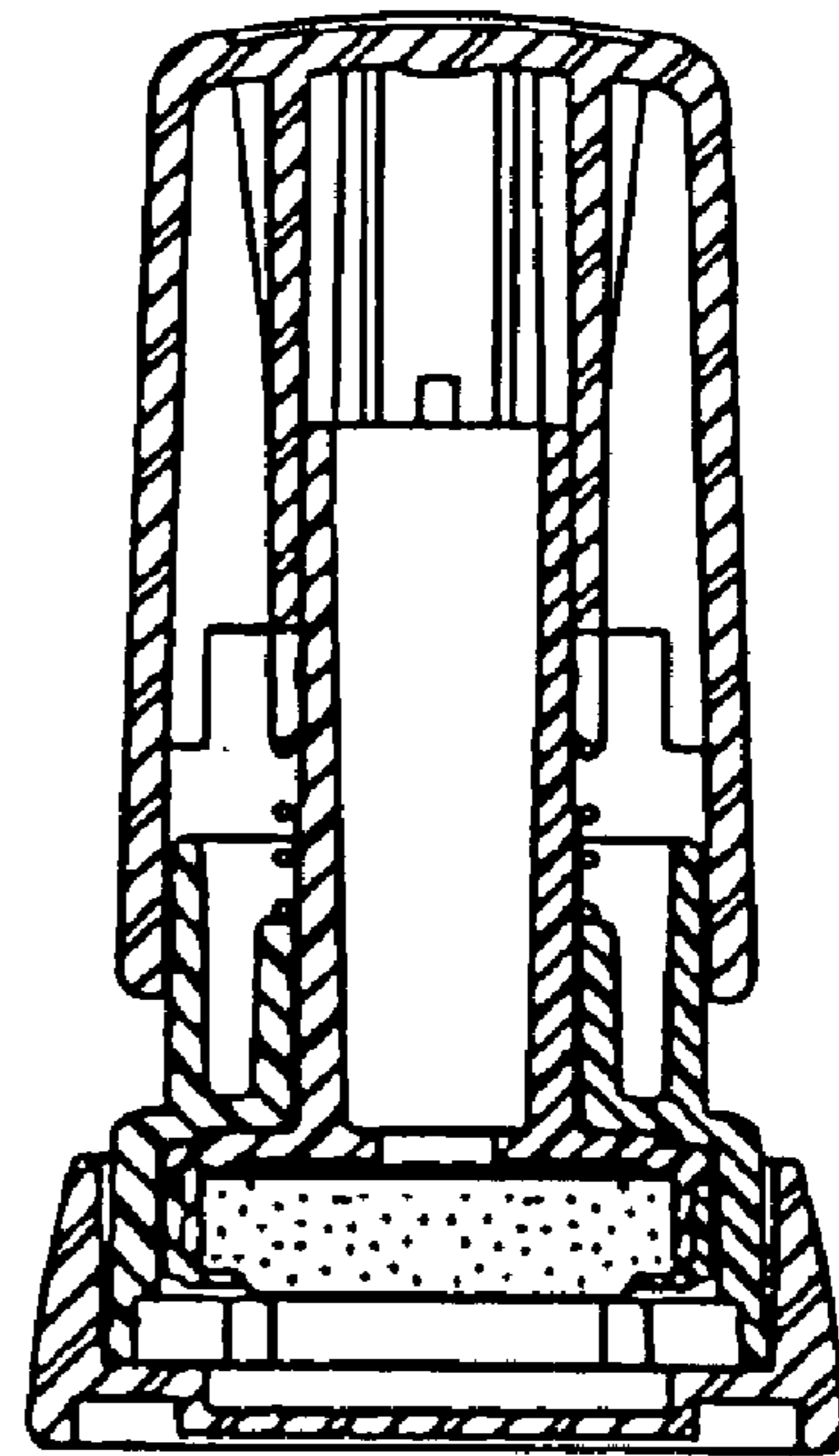

FIG.9

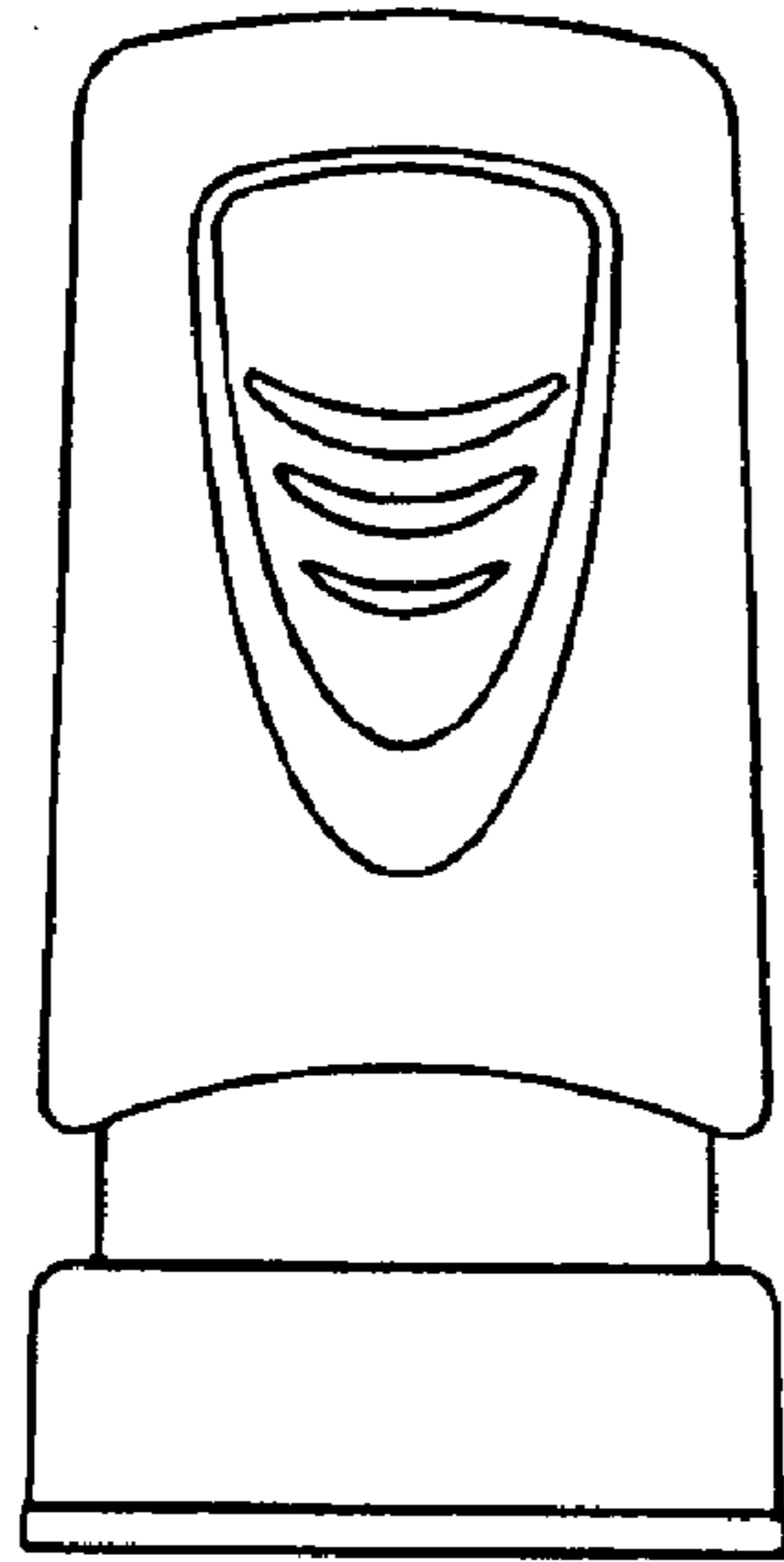

FIG.11

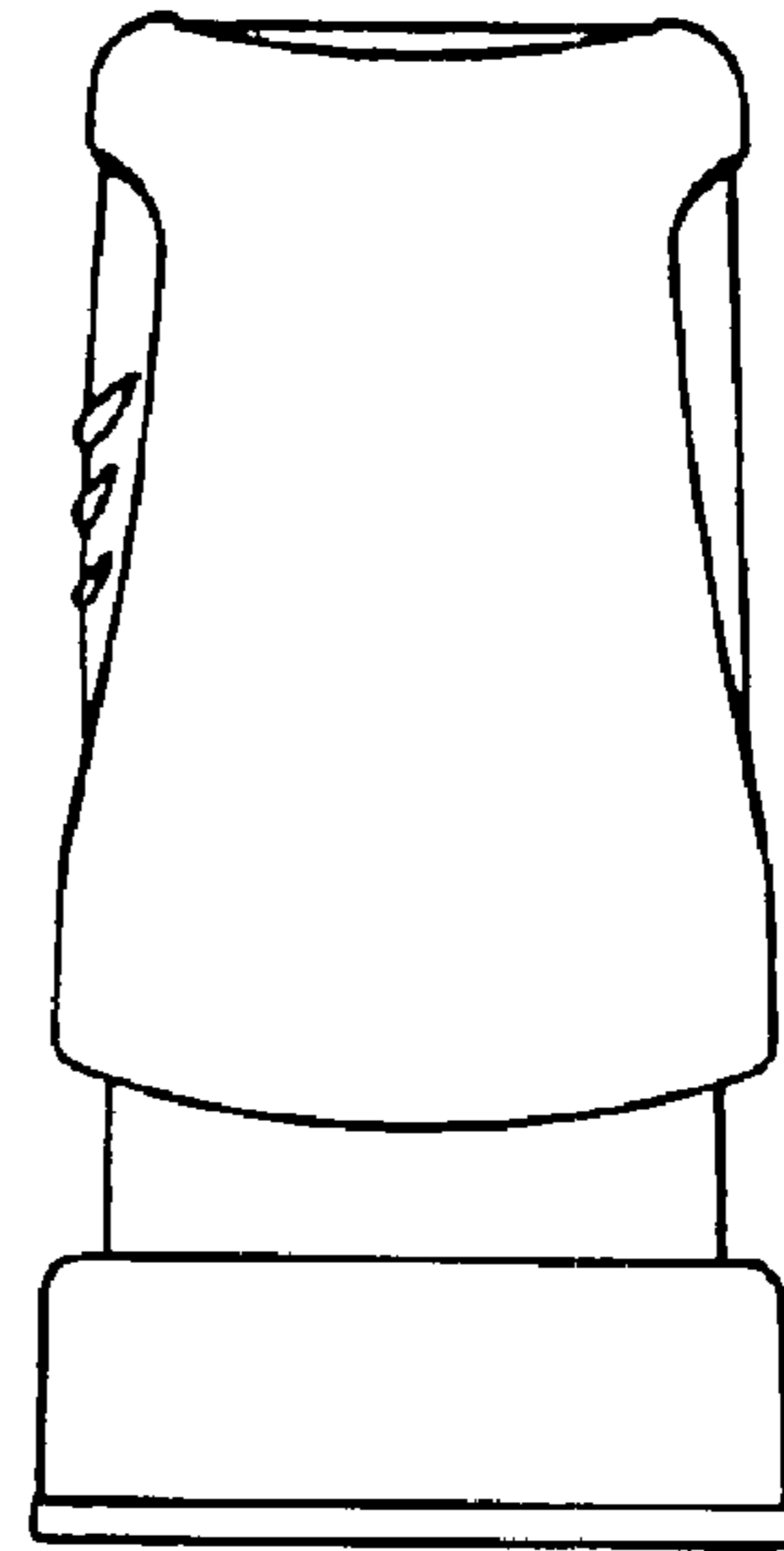

FIG.10

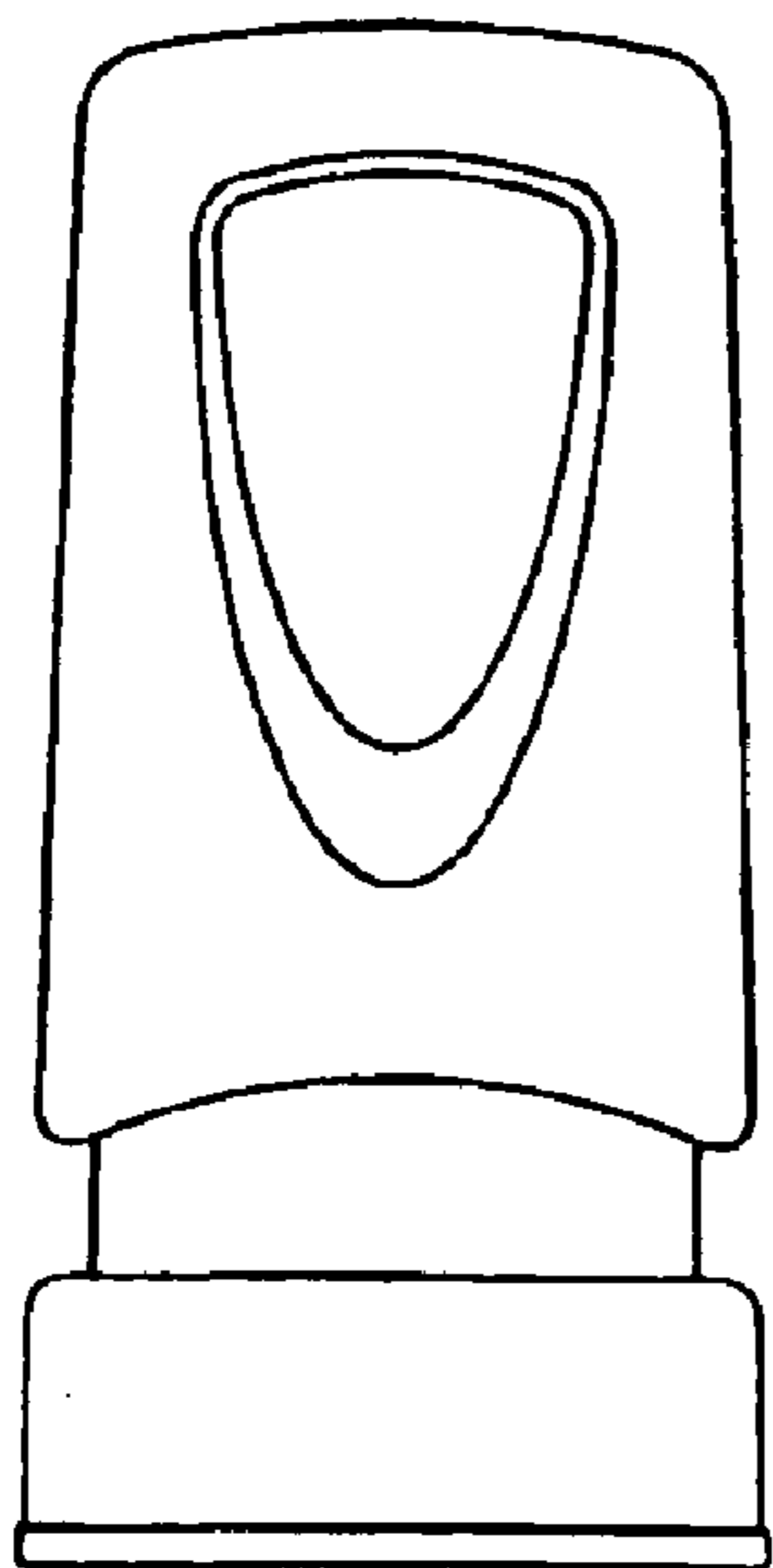

FIG.12

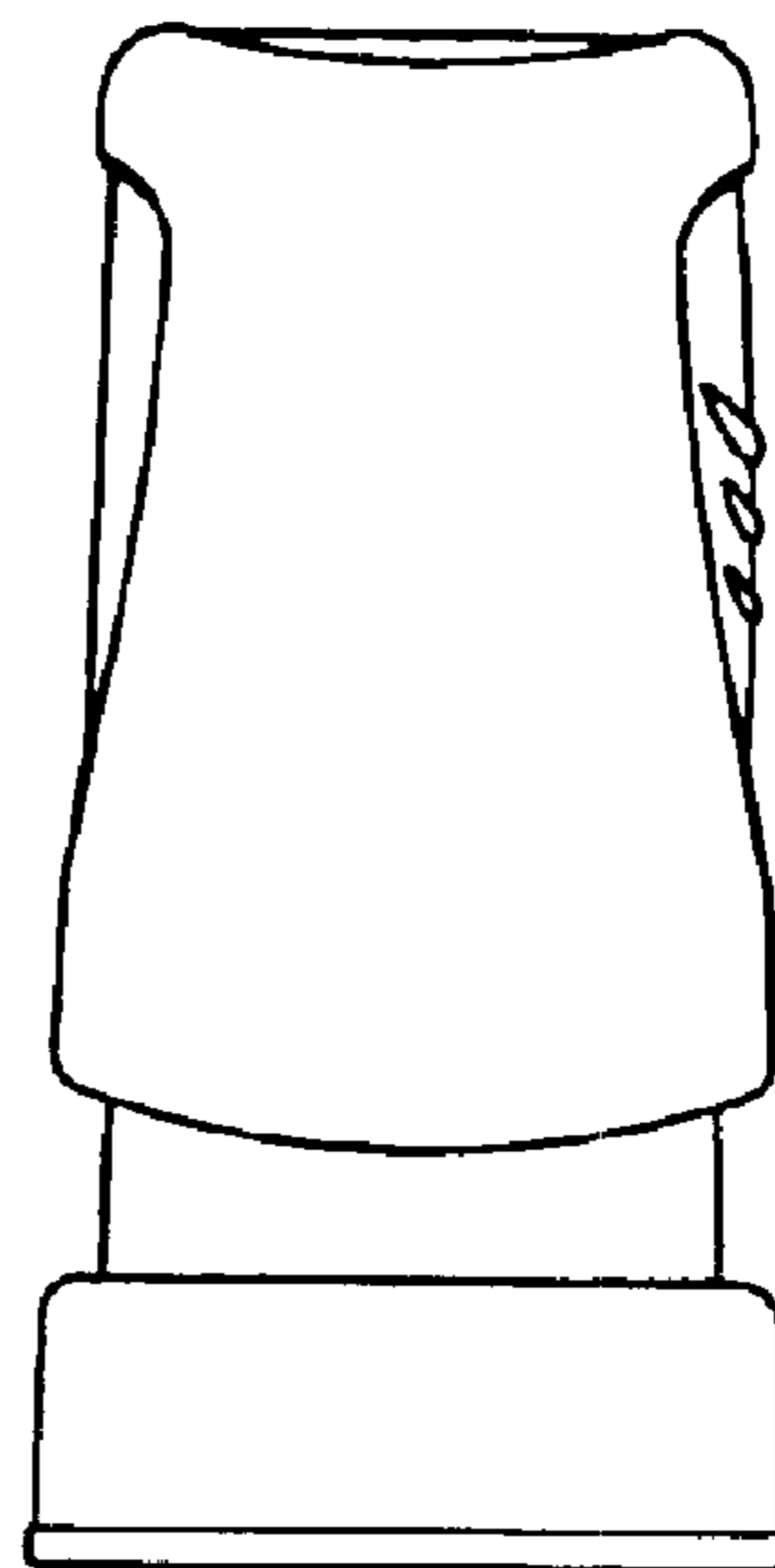

FIG.13

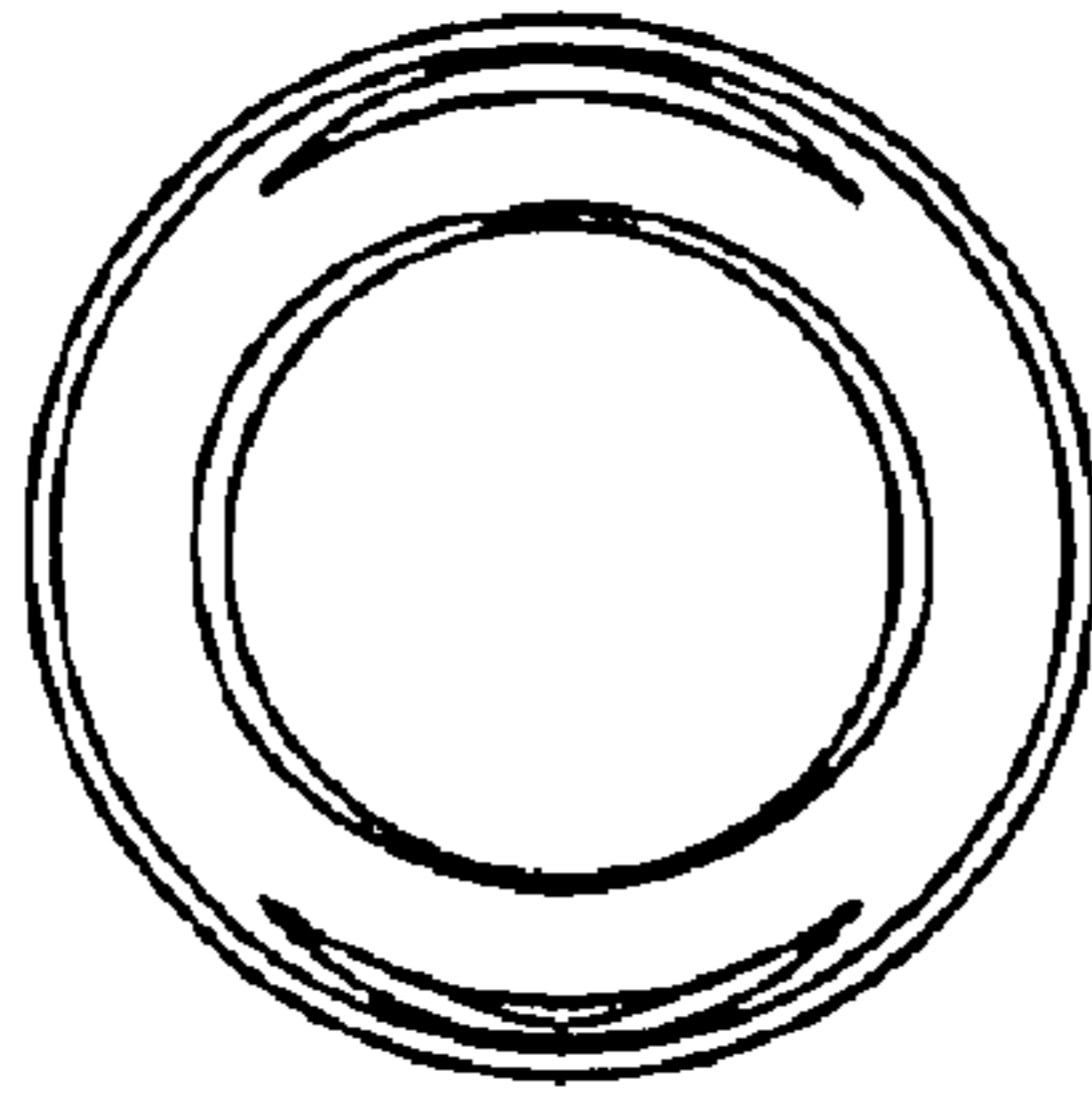

FIG.14

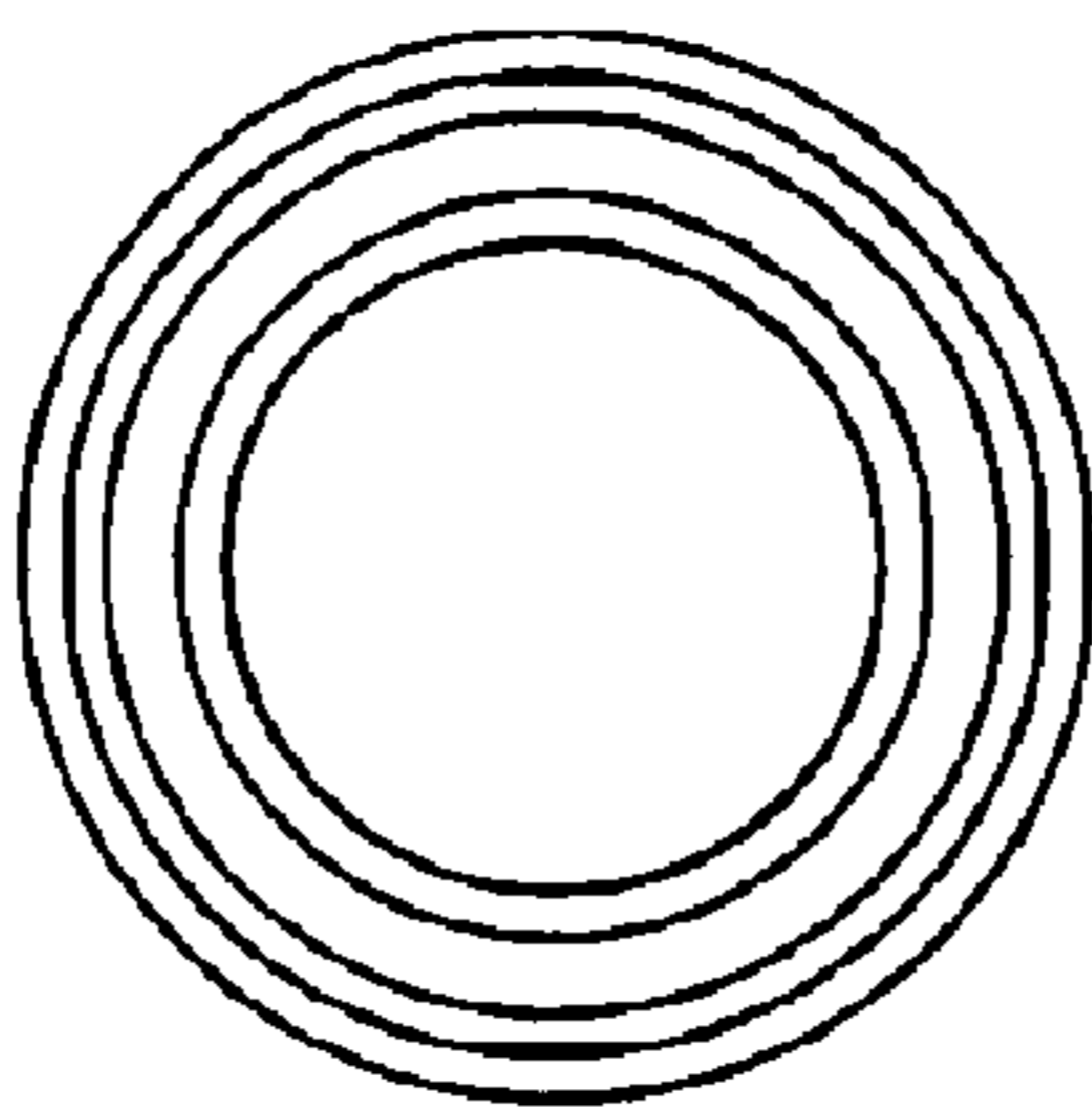

FIG.15



FIG.16

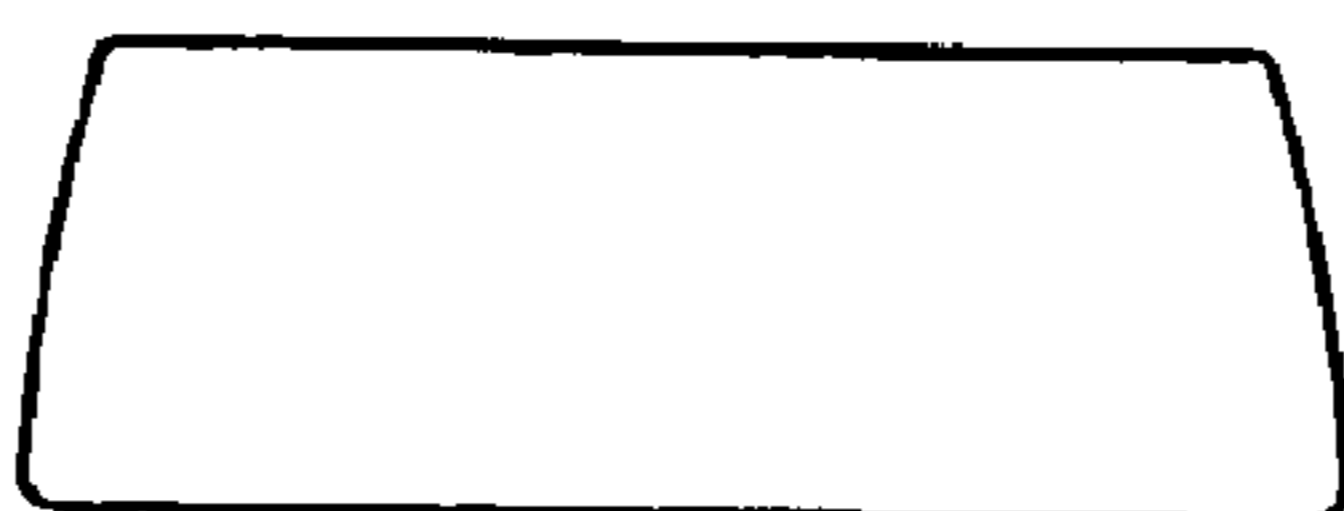

FIG.17

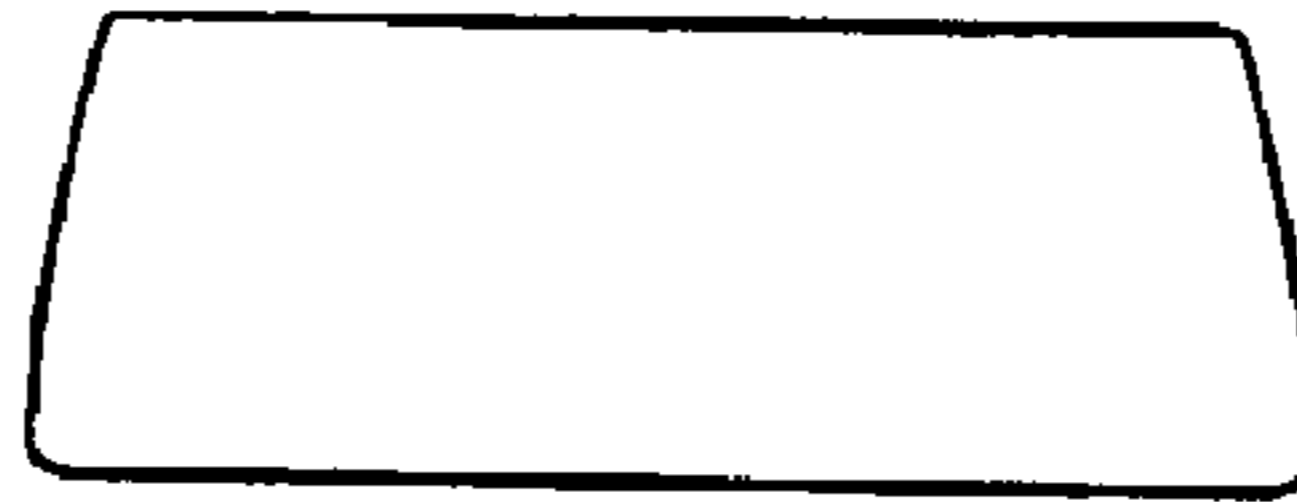

FIG.18



FIG.19

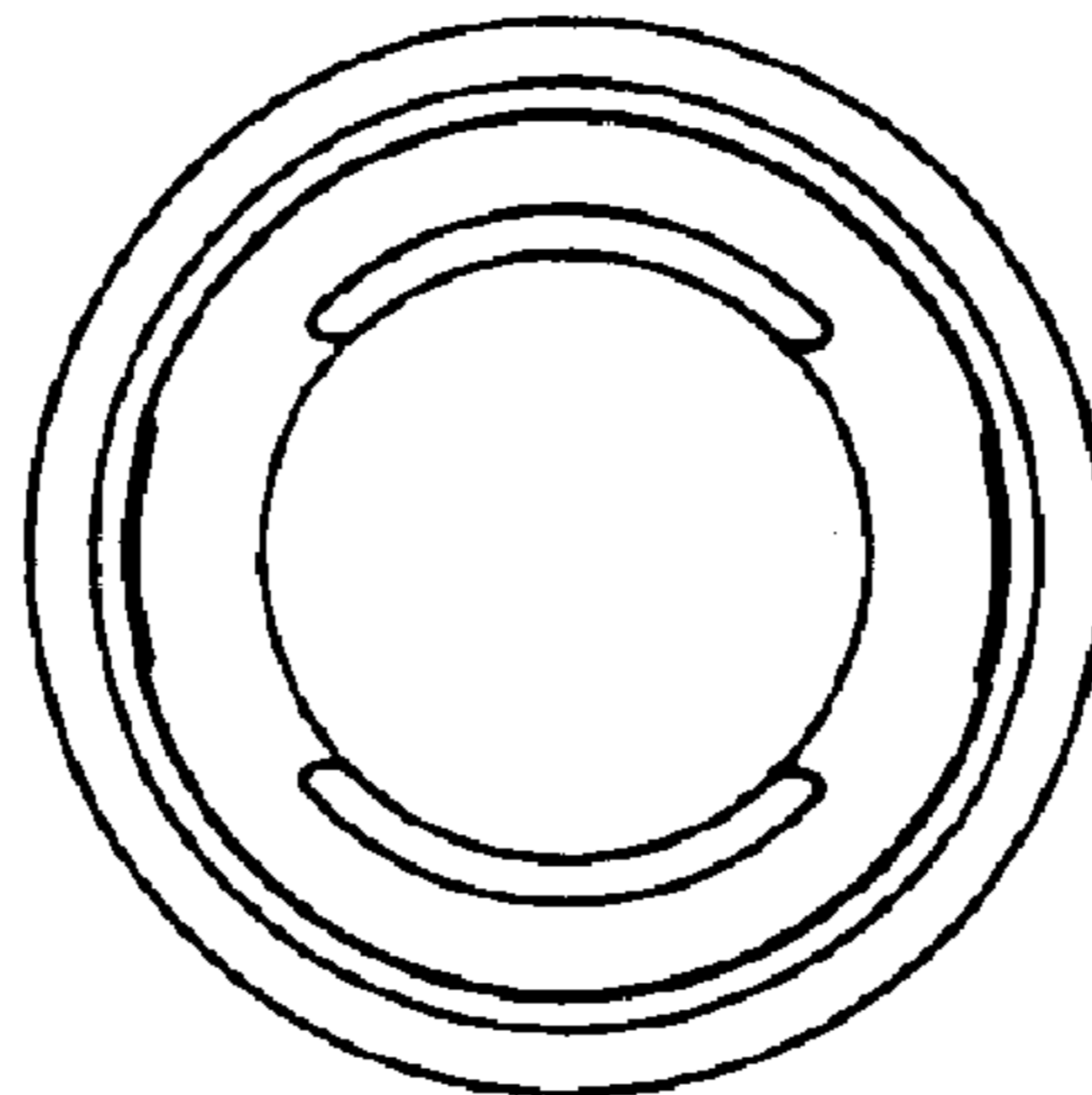

FIG.20

