

US00D508003S

(12) **United States Design Patent**
Kushima et al.

(10) **Patent No.:** **US D508,003 S**
(45) **Date of Patent:** **** Aug. 2, 2005**

(54) **OUTER MIRROR FOR AN AUTOMOBILE**

D490,351 S * 5/2004 Wang D12/187

(75) Inventors: **Yukio Kushima**, Aichi-ken (JP);
Shunsaku Kodama, Aichi-ken (JP)

(73) Assignee: **Toyota Jidosha Kabushiki Kaisha** (JP)

(**) Term: **14 Years**

(21) Appl. No.: **29/200,414**

(22) Filed: **Feb. 26, 2004**

(30) **Foreign Application Priority Data**

Nov. 21, 2003 (JP) 2003-034823

(51) **LOC (8) Cl.** **12-16**

(52) **U.S. Cl.** **D12/187**

(58) **Field of Search** D12/187-189;
359/830-856, 864-881; 248/475.1, 476

(56) **References Cited**

U.S. PATENT DOCUMENTS

D372,450 S * 8/1996 Santo D12/187
D427,127 S * 6/2000 Horowitz D12/187
D478,853 S * 8/2003 Boyer D12/187

OTHER PUBLICATIONS

Mitsubishi Motors GRANDIS, Automotive Guidebook of Japan, Oct. 22, 2003, pp. 116 and 117.

* cited by examiner

Primary Examiner—Melody N. Brown

(74) *Attorney, Agent, or Firm*—Saidman DesignLaw Group

(57) **CLAIM**

The ornamental design for an outer mirror for an automobile, as shown and described.

DESCRIPTION

FIG. 1 is a perspective view of an outer mirror for an automobile showing our new design;
FIG. 2 is a front view thereof;
FIG. 3 is a rear view thereof;
FIG. 4 is a top view thereof;
FIG. 5 is a bottom view;
FIG. 6 is a right-side view thereof; and,
FIG. 7 is a left-side view thereof.

1 Claim, 3 Drawing Sheets

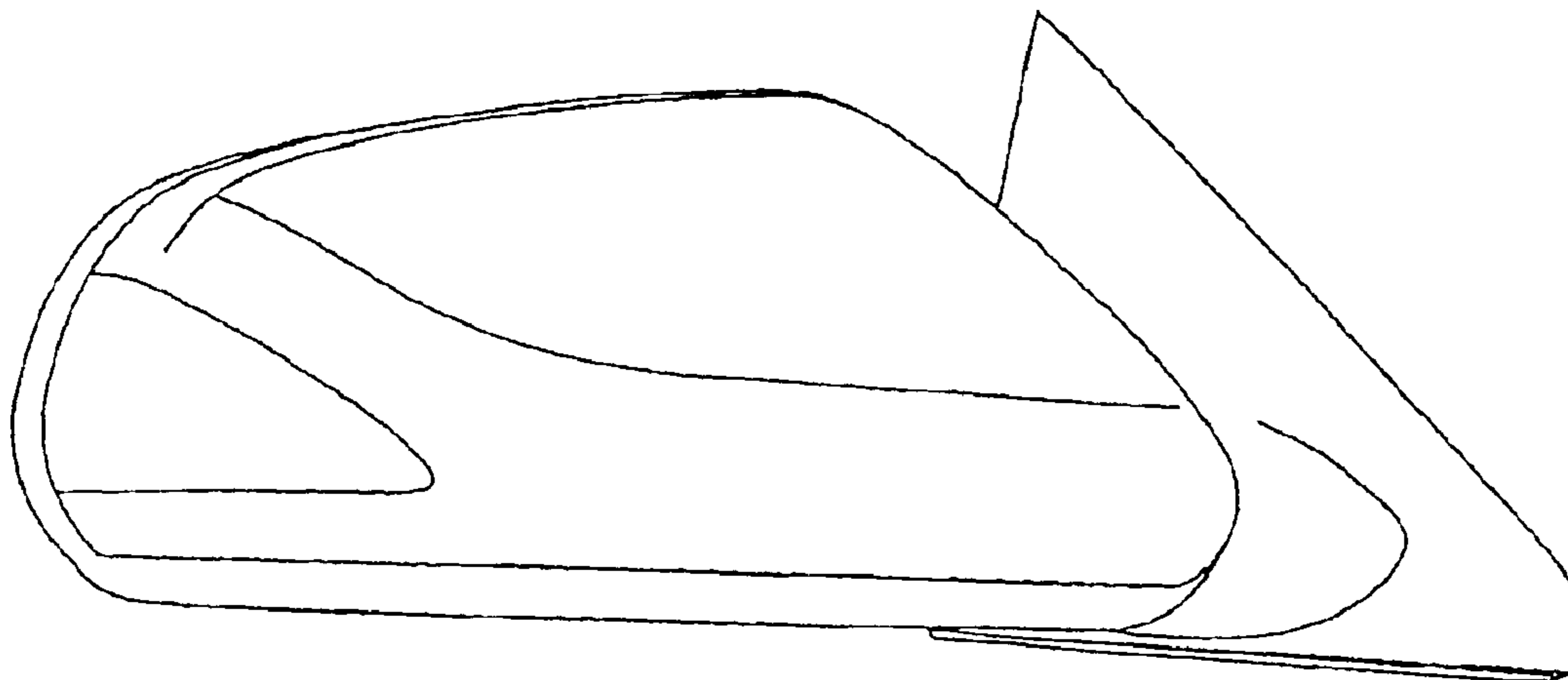

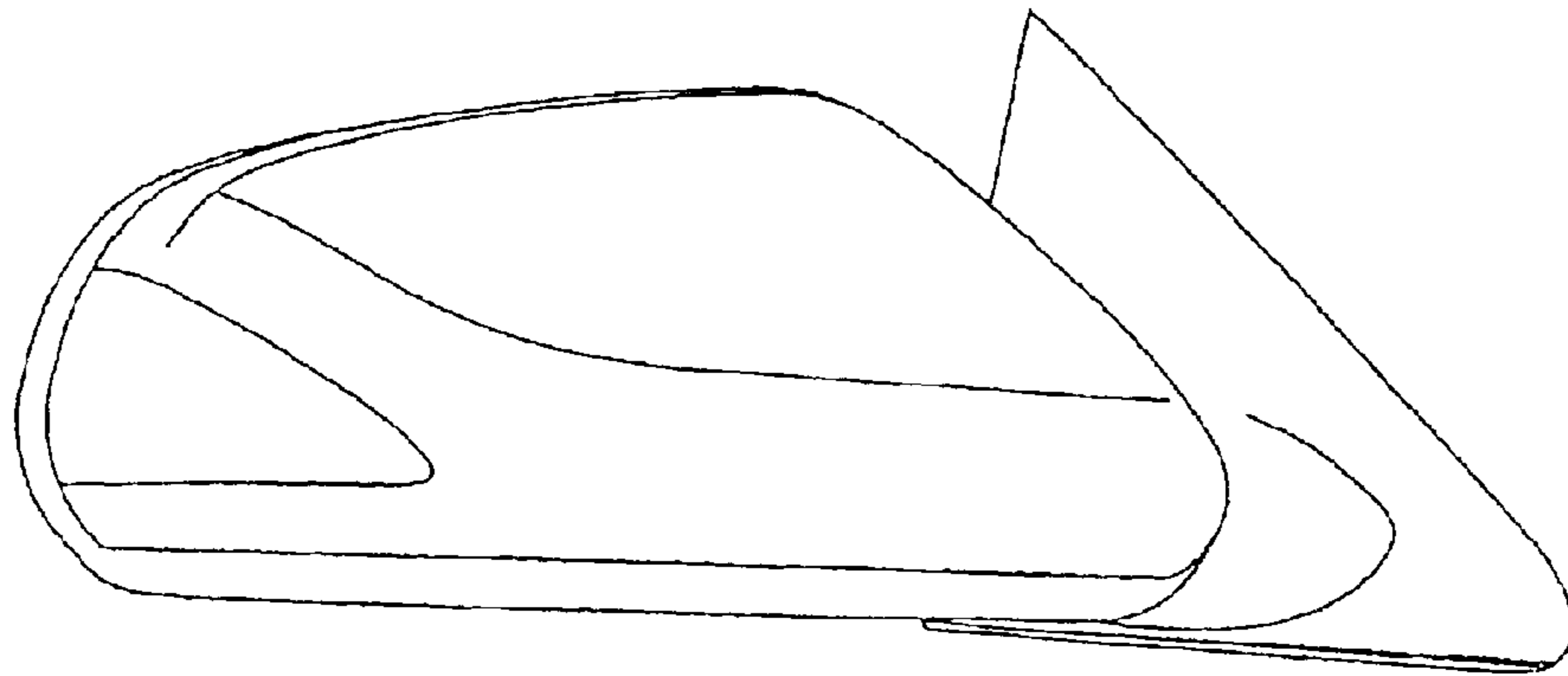

FIG. 1

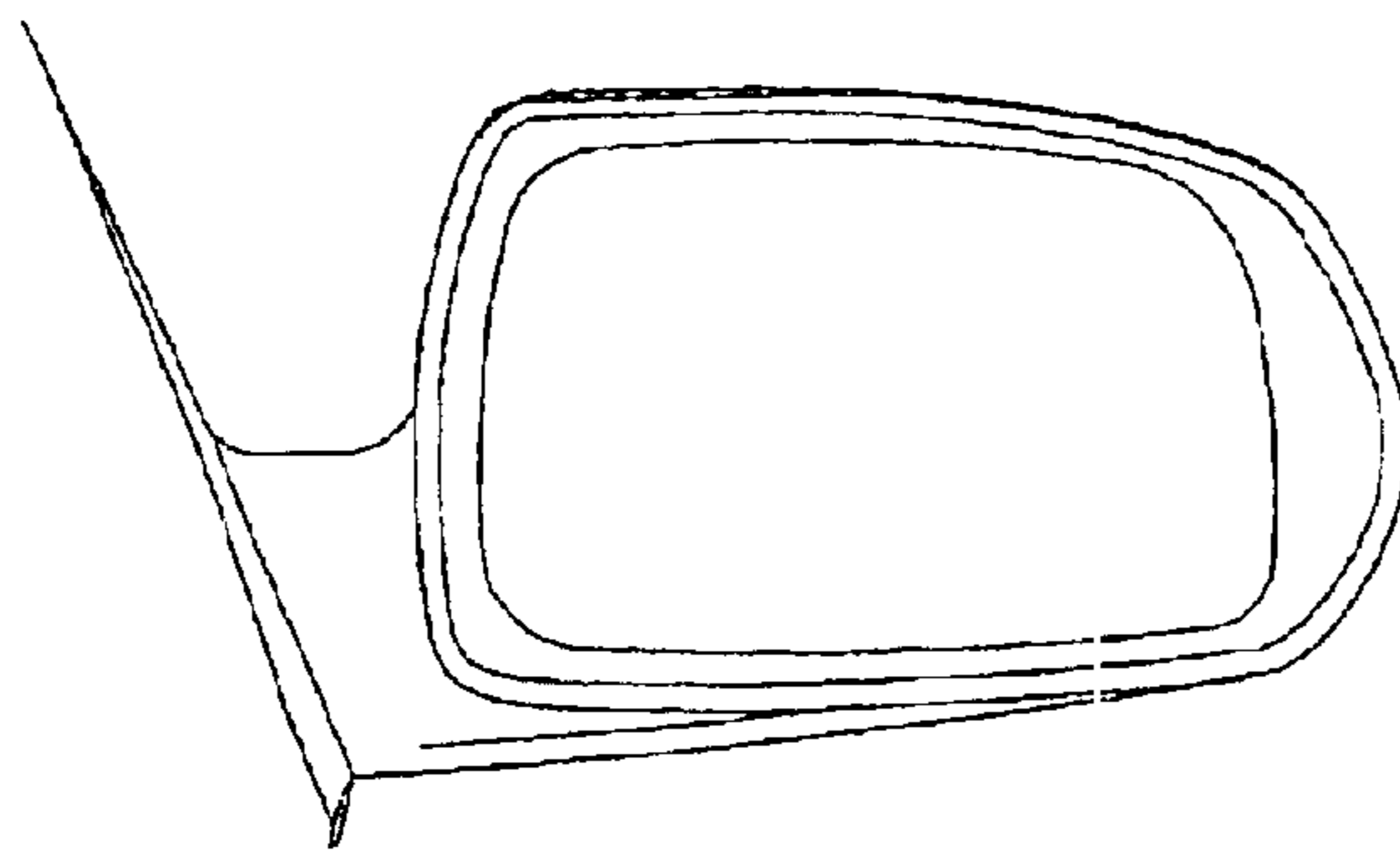

FIG. 2

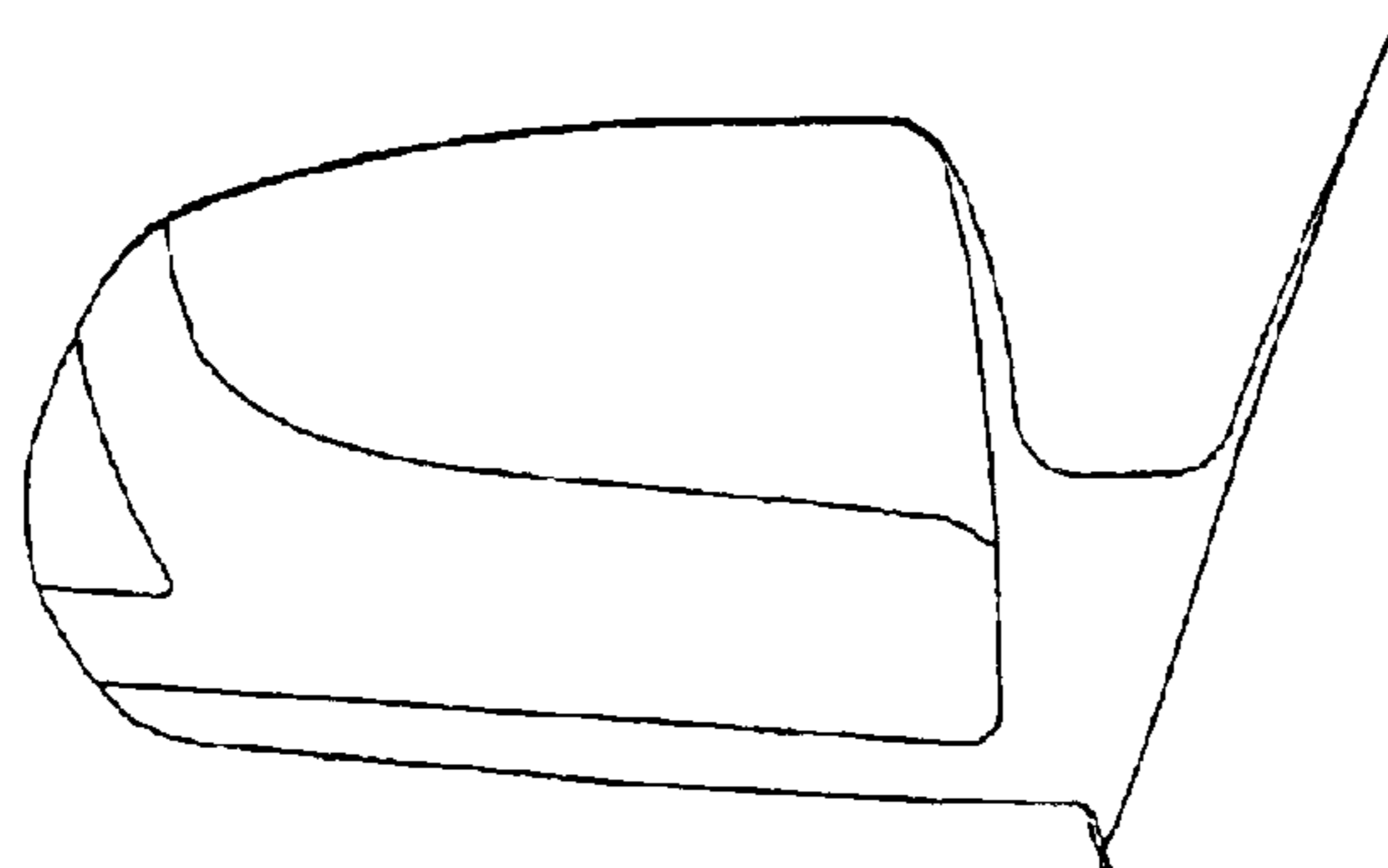

FIG. 3

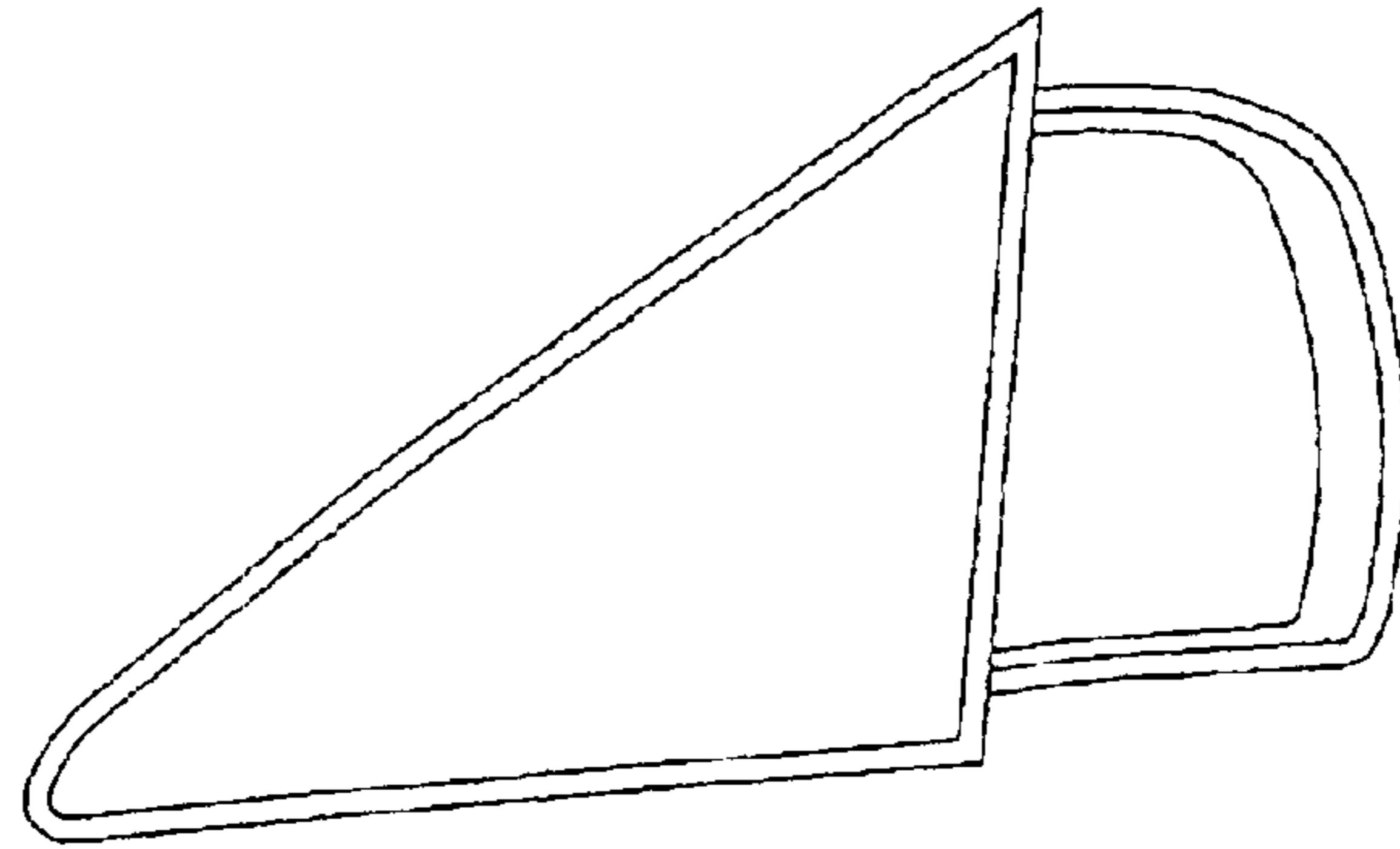

FIG. 7

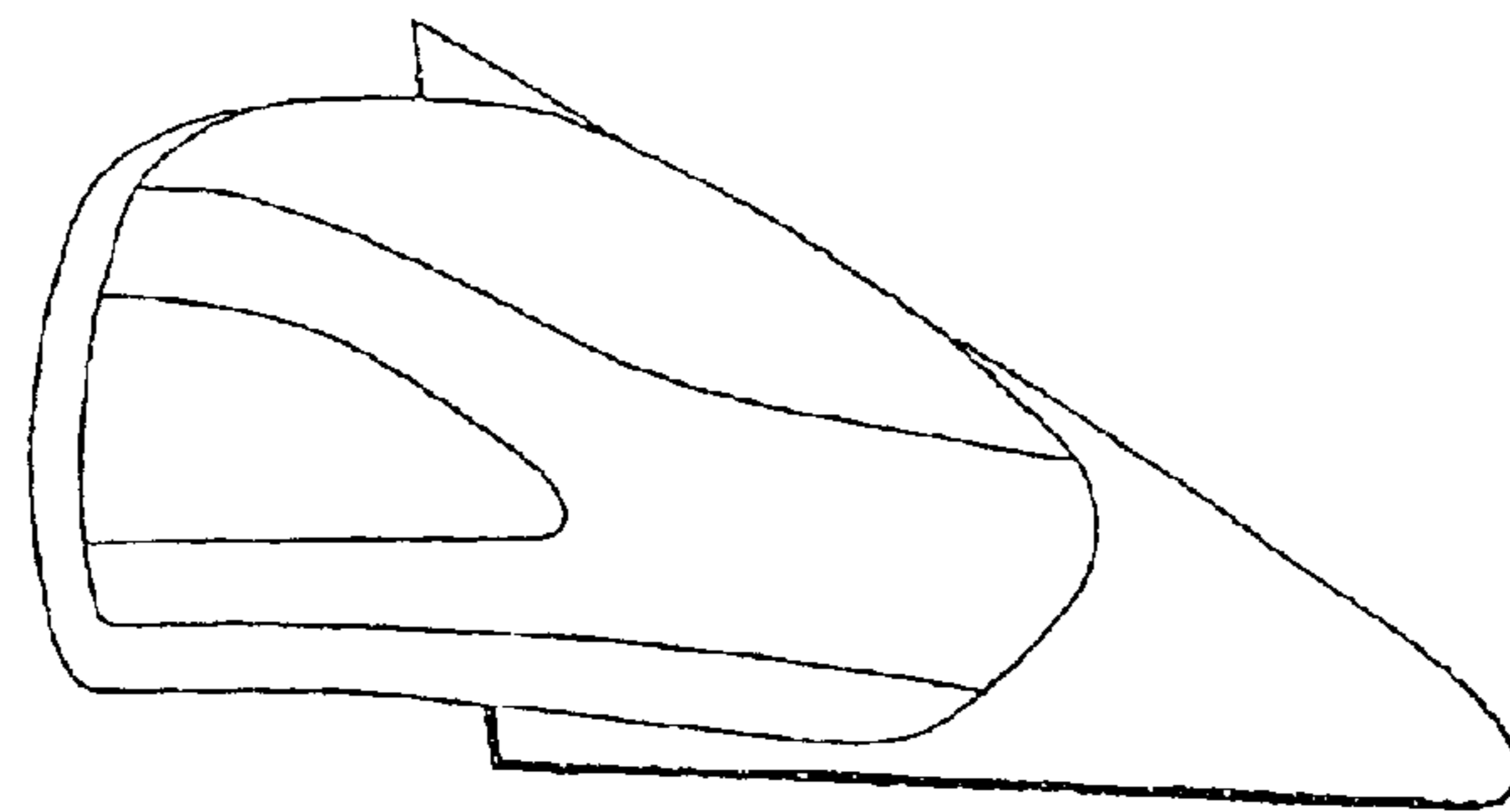

FIG. 6

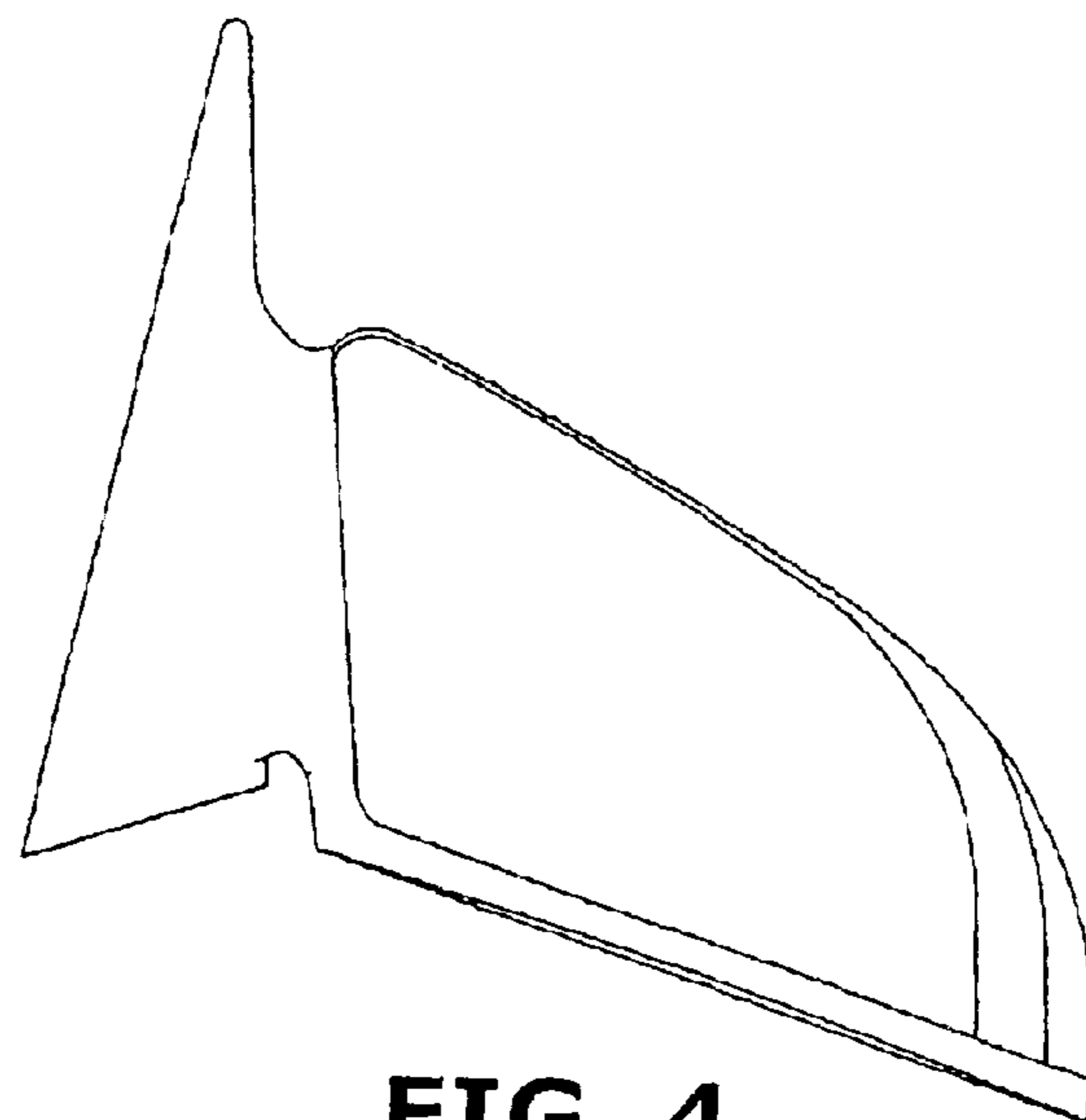

FIG. 4

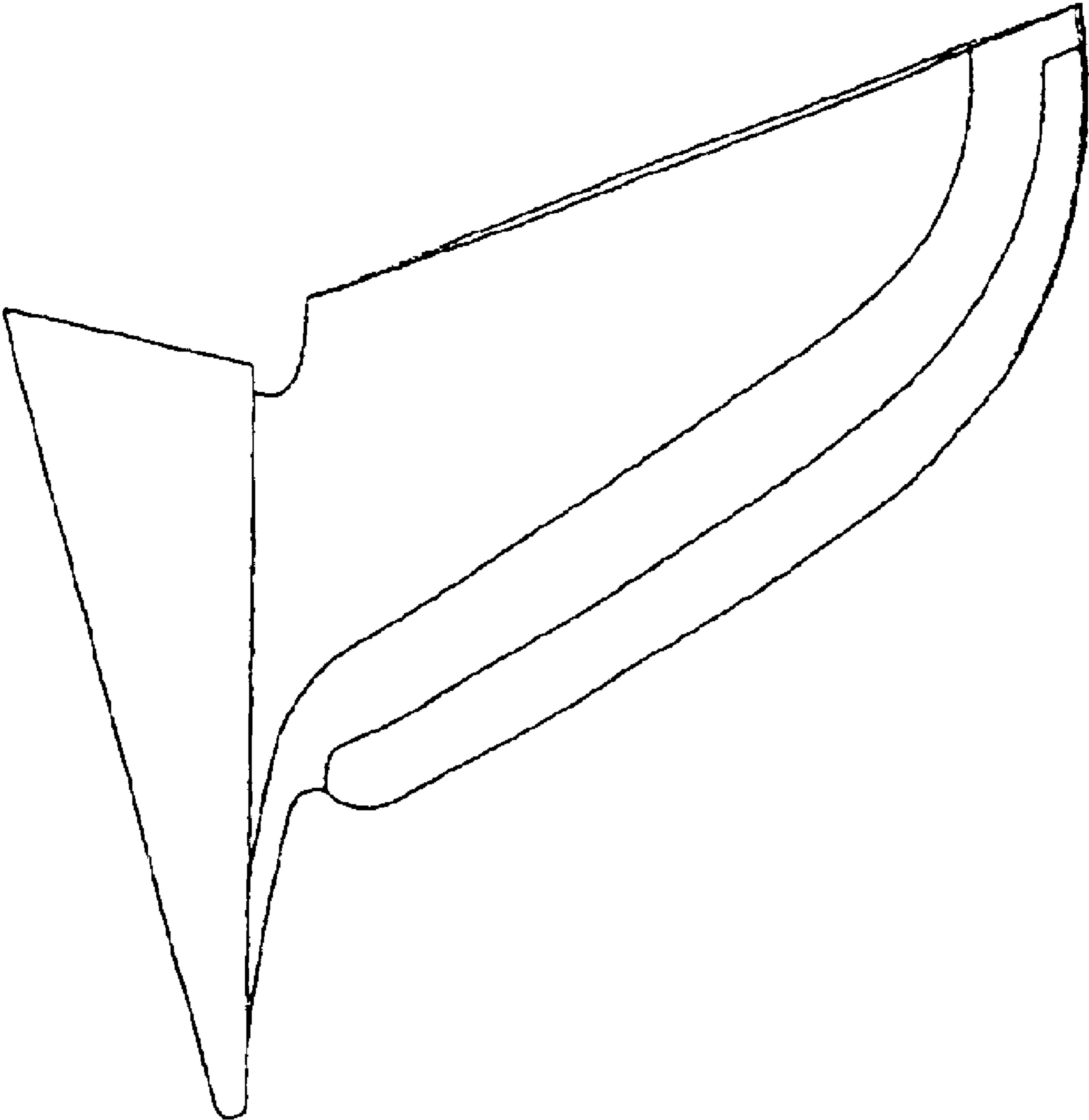

FIG. 5