



US00D507992S

(12) **United States Design Patent**
Stephenson

(10) **Patent No.:** **US D507,992 S**
(45) **Date of Patent:** **** Aug. 2, 2005**

(54) **CAR INCLUDING TOY-CAR, MOTOR-CAR, REPLICAR CAR AND SCALE-MODEL CAR**

D418,088 S * 12/1999 Fioravanti D12/92
D469,387 S * 1/2003 Ramaciotti D12/92
D478,843 S * 8/2003 Pardo D12/92
D500,263 S * 12/2004 Donckerwolke D12/92

(75) Inventor: **Frank Stephenson, Modena (IT)**

* cited by examiner

(73) Assignee: **Maserati S.p.A., Modena (IT)**

Primary Examiner—Melody N. Brown

(**) Term: **14 Years**

(74) *Attorney, Agent, or Firm*—Cowan, Liebowitz & Latman, P.C.

(21) Appl. No.: **29/211,893**

(22) Filed: **May 3, 2004**

(57) **CLAIM**

(30) **Foreign Application Priority Data**

The ornamental design for a car including toy-car, motor-car, replica car and scale-model car, as shown and described.

Nov. 7, 2003 (EM) 98777
Nov. 7, 2003 (EM) 105622

DESCRIPTION

(51) **LOC (8) Cl.** **12-08**

FIG. 1 is a perspective view of the car including toy-car, motor-car, replica car and scale-model car showing my design thereof;

(52) **U.S. Cl.** **D12/92**

FIG. 2 is a front view thereof;

(58) **Field of Search** D12/90-92, 86,

FIG. 3 is a left side view thereof;

D12/88; D21/424, 433; 296/185

FIG. 4 is a right side view thereof;

(56) **References Cited**

FIG. 5 is a rear view thereof;

U.S. PATENT DOCUMENTS

FIG. 6 is a top view thereof; and,

D392,596 S * 3/1998 Jungst D12/92

FIG. 7 is a bottom view thereof.

D398,561 S * 9/1998 Aufrecht D12/92

D402,922 S * 12/1998 Singer et al. D12/92

1 Claim, 7 Drawing Sheets

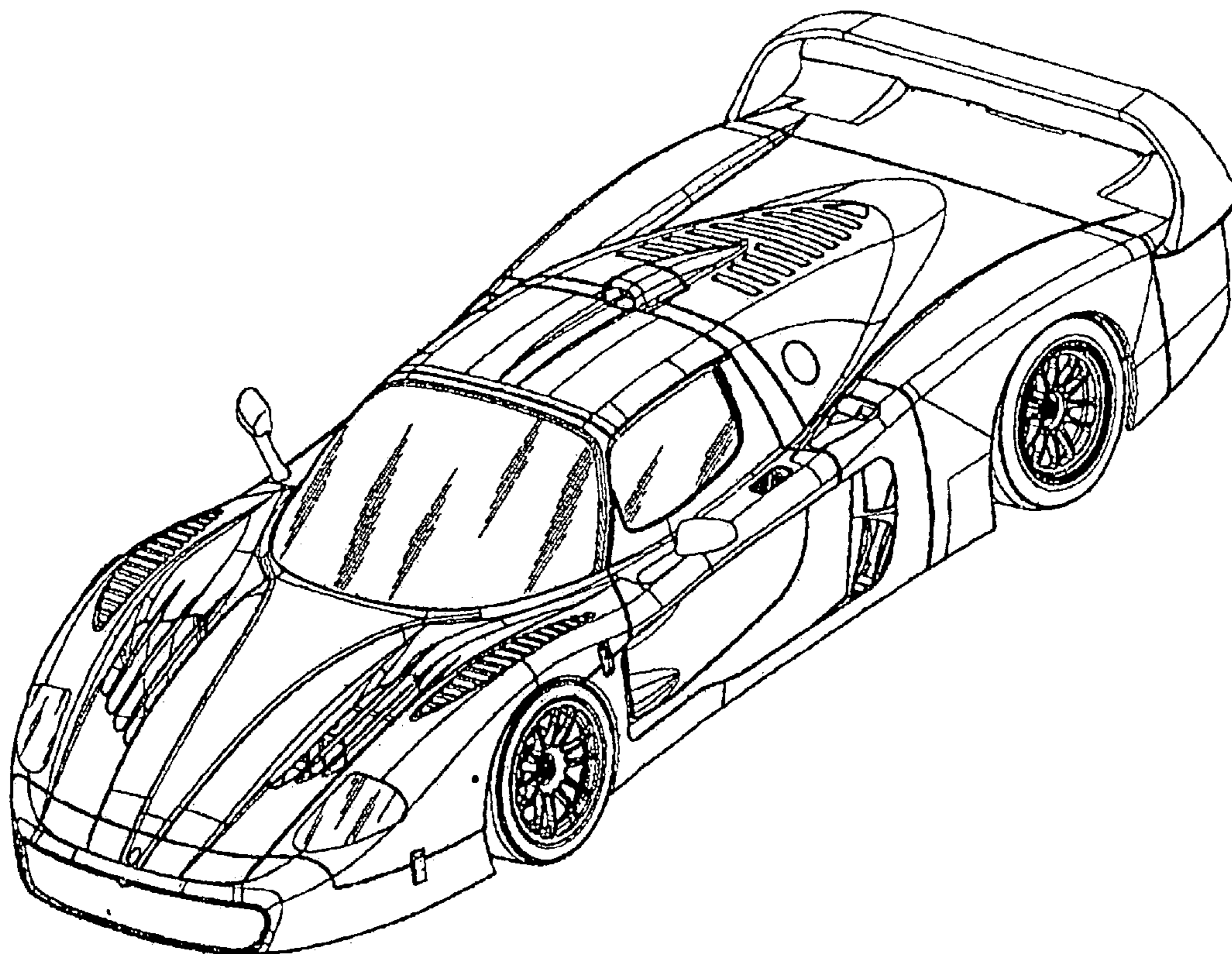

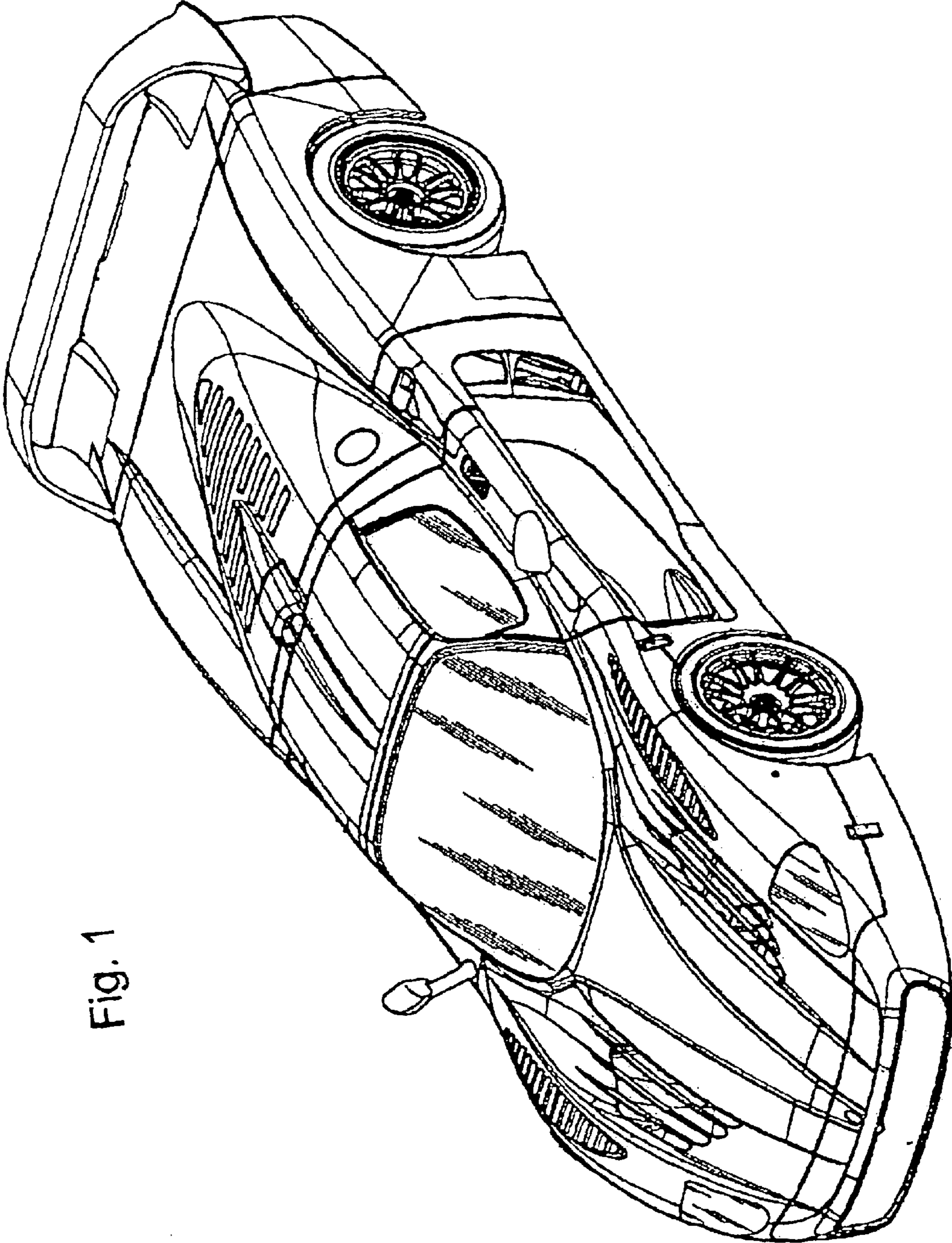

Fig. 1

Fig. 2

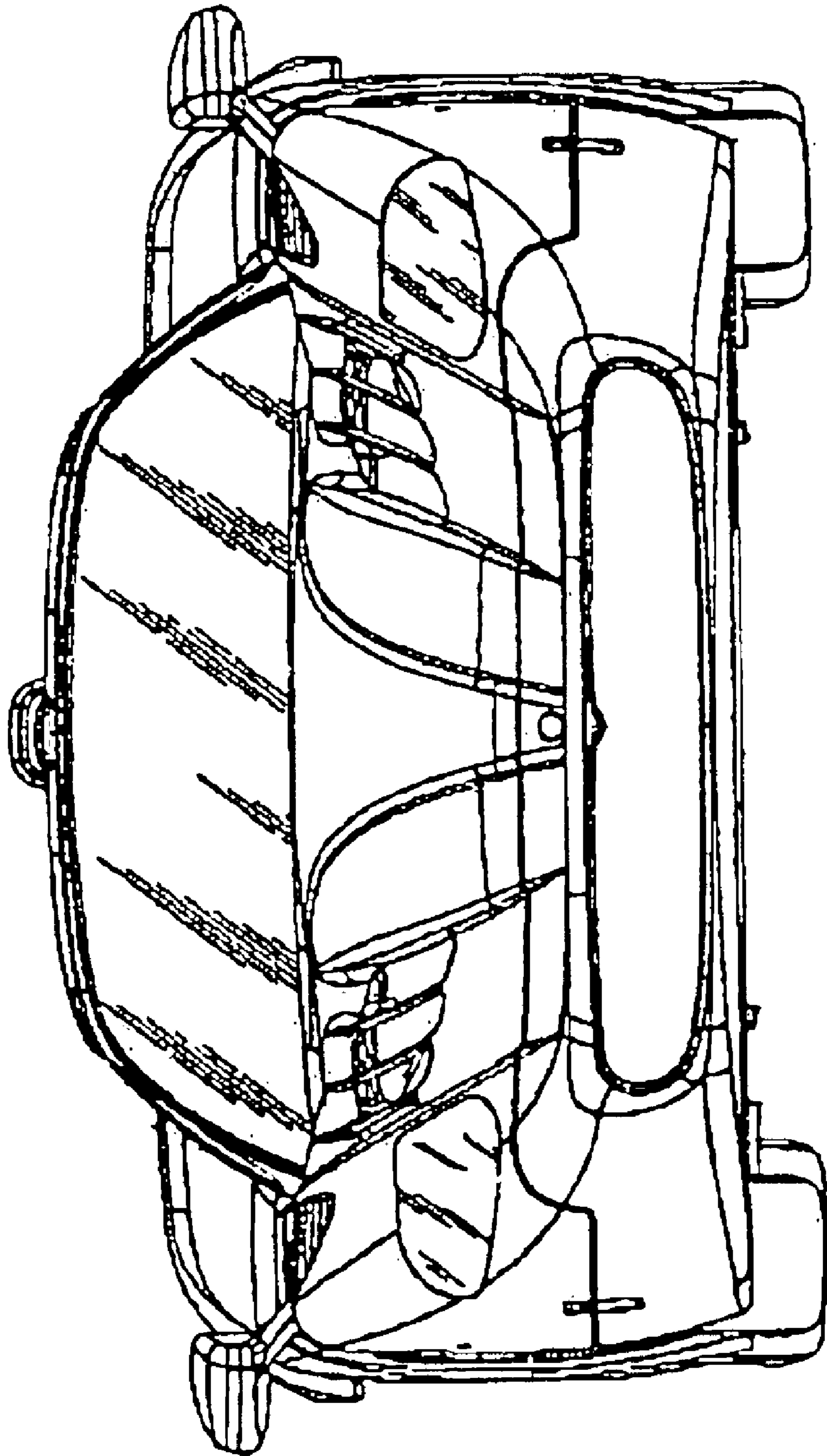

Fig. 3

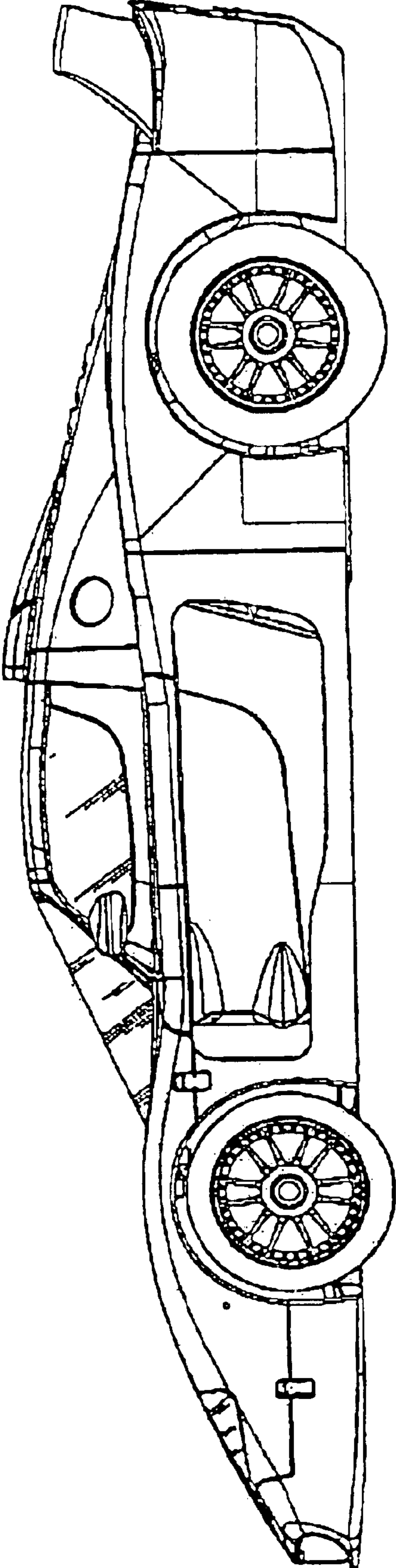

Fig. 4

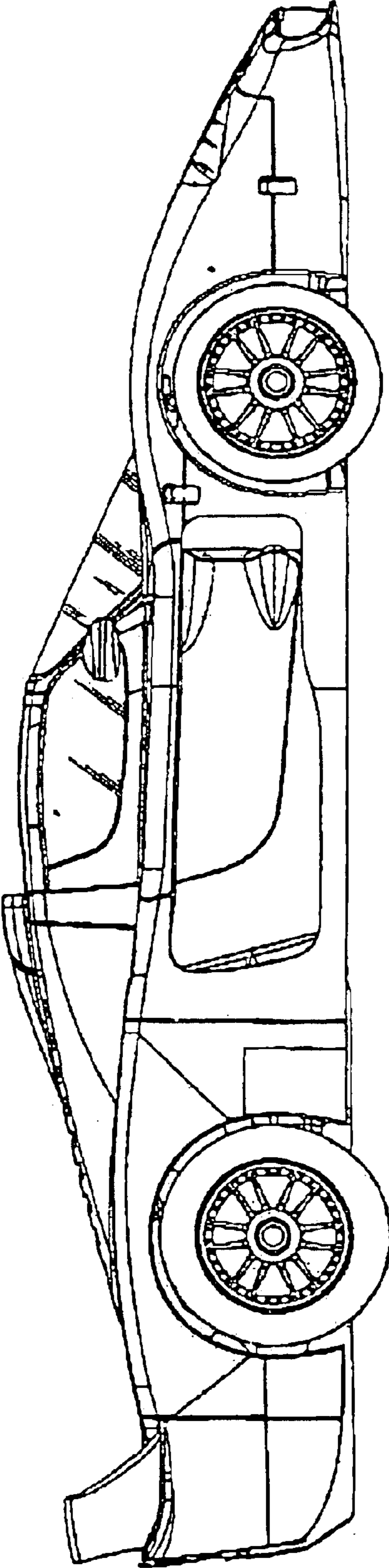

Fig. 5

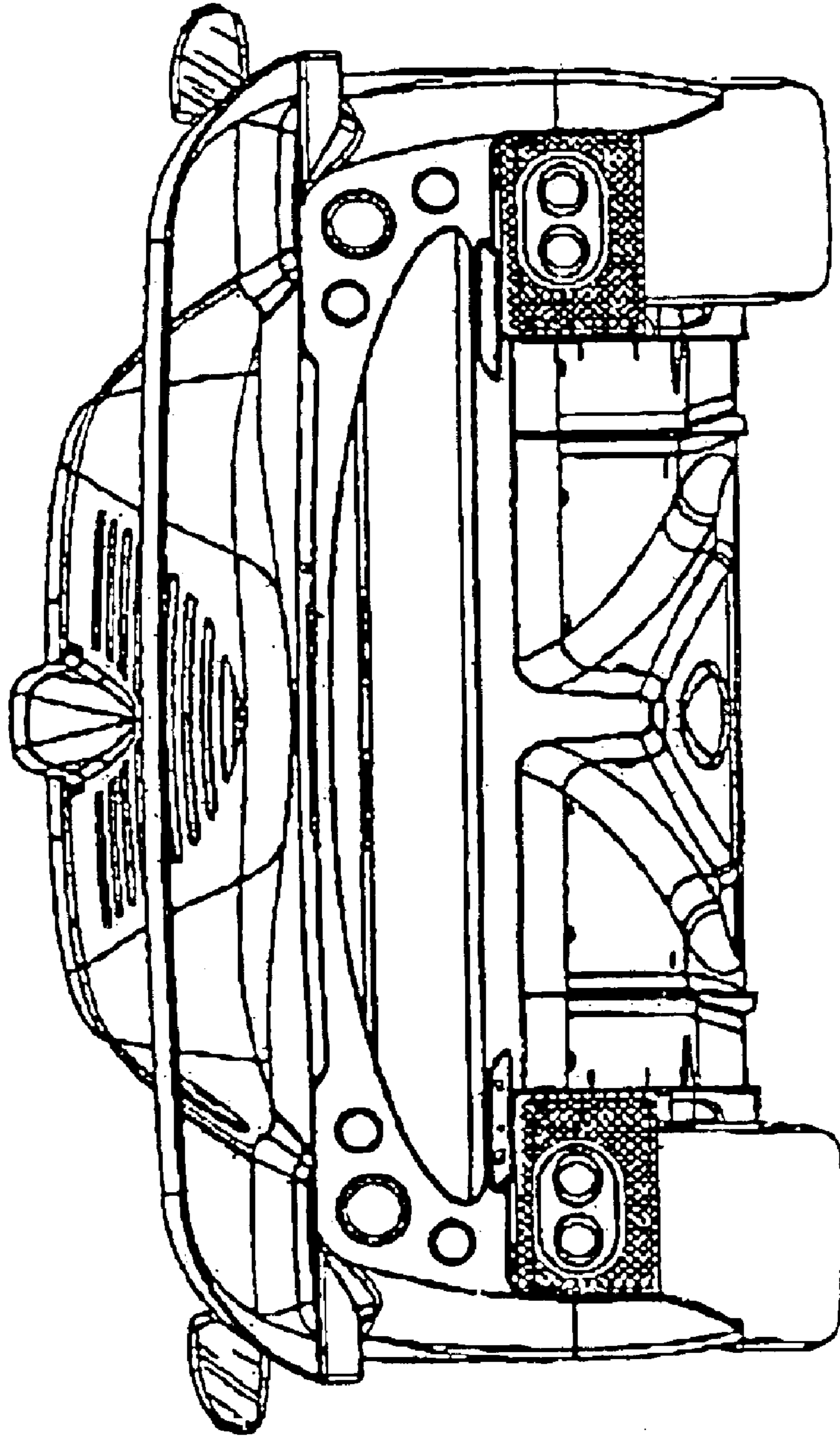

Fig. 6

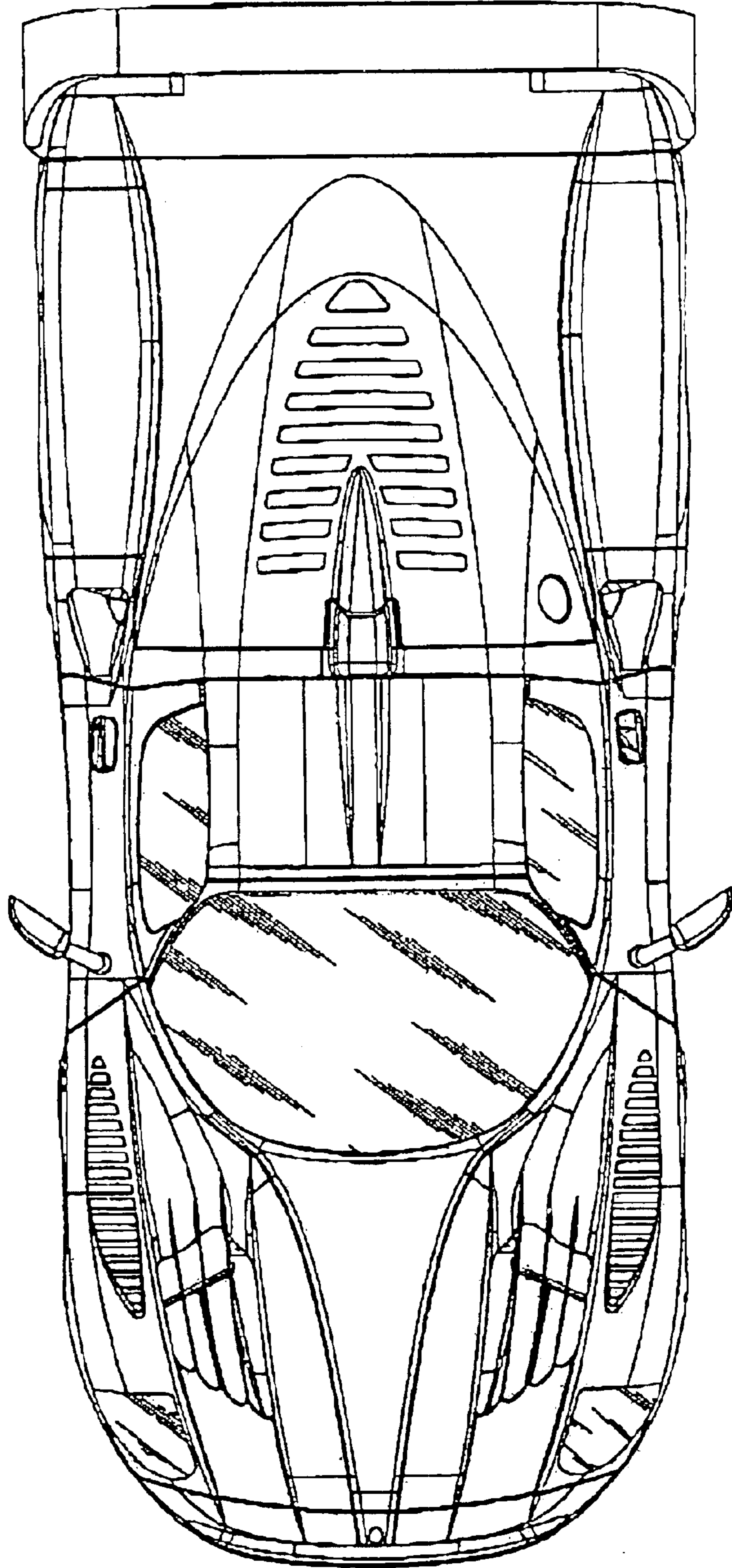

Fig. 7

