

US00D507911S

(12) **United States Design Patent** (10) **Patent No.:** **US D507,911 S**  
**Schweikarth et al.** (45) **Date of Patent:** **\*\* Aug. 2, 2005**

(54) **CHAIR BACKREST AND ARMREST ASSEMBLY**

D460,870 S 7/2002 Van De Riet et al. .... D6/366  
D461,327 S 8/2002 Pearce et al. .... D6/368  
D463,174 S 9/2002 Chu ..... D6/500

(75) Inventors: **Derek R. Schweikarth**, Jasper, IN (US); **Chad M. Kieffner**, Jasper, IN (US)

(Continued)

(73) Assignee: **Kimball International, Inc.**, Jasper, IN (US)

**OTHER PUBLICATIONS**

Images of Herman Miller, Hon, Teknion, Steelcase and Vecta prior art chairs.

(\*\*) Term: **14 Years**

*Primary Examiner*—Mimosa De  
(74) *Attorney, Agent, or Firm*—Baker & Daniels

(21) Appl. No.: **29/201,436**

(57) **CLAIM**

(22) Filed: **Mar. 16, 2004**

The ornamental design for a chair backrest and armrest assembly, as shown and described.

(51) **LOC (8) Cl.** ..... **06-06**

(52) **U.S. Cl.** ..... **D6/502; D6/366**

(58) **Field of Search** ..... D6/334, 335, 364, D6/365, 366, 367, 500, 501, 502; 297/411.2, 411.28, 411.29, 452.29

**DESCRIPTION**

(56) **References Cited**

**U.S. PATENT DOCUMENTS**

766,484 A	8/1904	Armstrong	
2,602,489 A	7/1952	Holten	155/161
4,828,320 A	5/1989	Saiger	297/229
D327,782 S	7/1992	Citterio	D6/366
5,667,274 A	9/1997	Blackman	297/338
D400,018 S	10/1998	James et al.	D6/366
D401,453 S	11/1998	Holt	D6/502
D408,161 S	4/1999	Caruso	D6/366
D411,928 S	7/1999	Ritch et al.	D6/500
6,099,076 A	8/2000	Nagel et al.	297/337
D446,954 S	8/2001	Sottsass	D6/366
D449,172 S	10/2001	Van De Riet et al.	D6/366
D449,938 S	11/2001	Van De Riet et al.	D6/380
D451,693 S	12/2001	Pearce et al.	D6/368
D455,571 S	4/2002	Van De Riet et al.	D6/374
D456,160 S	4/2002	Van De Riet et al.	D6/366
D456,164 S	4/2002	Van De Riet et al.	D6/374
D456,627 S	5/2002	Pearce et al.	D6/366
D457,007 S	5/2002	Pearce et al.	D6/368
D457,739 S	5/2002	Pearce et al.	D6/366
6,386,636 B2	5/2002	Caruso et al.	297/353

FIG. 1 is a front perspective view of a chair backrest and armrest assembly according to a first embodiment of our design;  
FIG. 2 is a front view thereof;  
FIG. 3 is a rear view thereof;  
FIG. 4 is a left side view thereof;  
FIG. 5 is a right side view thereof;  
FIG. 6 is a top view of thereof;  
FIG. 7 is a front perspective view of a chair backrest and armrest assembly according to a second embodiment of our new design, the second embodiment identical to the first embodiment except that the second embodiment lacks a hole in the upper portion of the backrest;  
FIG. 8 is a front perspective view of a chair backrest and armrest assembly according to a third embodiment of our design, the backrest including a cushion cover;  
FIG. 9 is a front view thereof;  
FIG. 10 is a rear view thereof;  
FIG. 11 is a left side view thereof;  
FIG. 12 is a right side view thereof; and,  
FIG. 13 is a top view of thereof.  
The features shown in dashed lines form no part of the claimed designs.

**1 Claim, 13 Drawing Sheets**

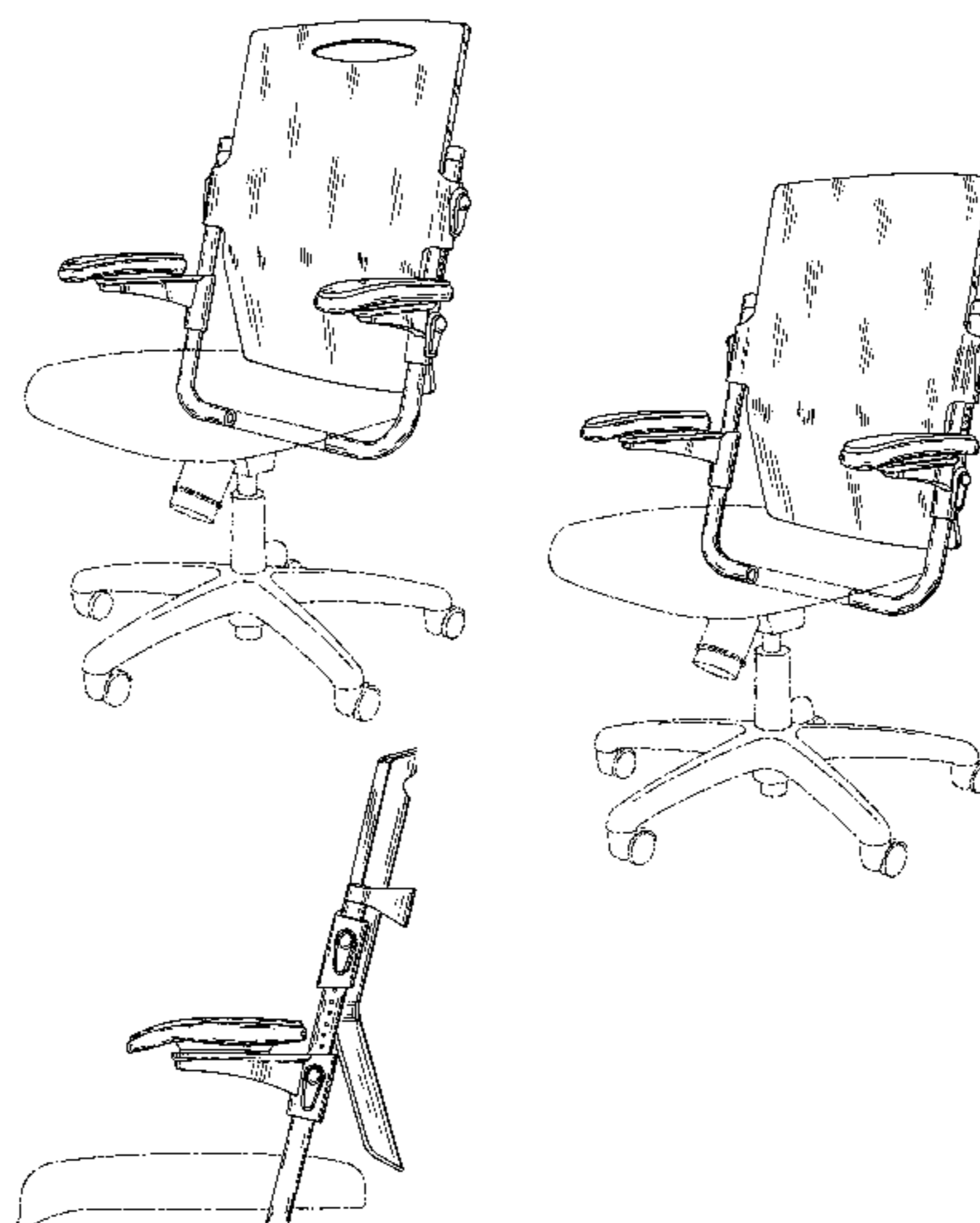

# US D507,911 S

Page 2

---

## U.S. PATENT DOCUMENTS

D463,920 S	10/2002	Pearce et al. ....	D6/366	D487,197 S	*	3/2004	Edwards et al. ....	D6/366
D465,938 S	11/2002	Huang .....	D6/366	D487,641 S	*	3/2004	James .....	D6/366
D479,416 S	*	9/2003	Raftery .....	D490,621 S	*	6/2004	Newhouse .....	D6/366
D484,710 S	*	1/2004	Getzel .....	D493,626 S	*	8/2004	James .....	D6/366
D485,097 S	*	1/2004	Raftery .....	2002/0158500 A1		10/2002	Chu et al. ....	297/411.36
D486,315 S	*	2/2004	Beaulieu et al. ....					

\* cited by examiner

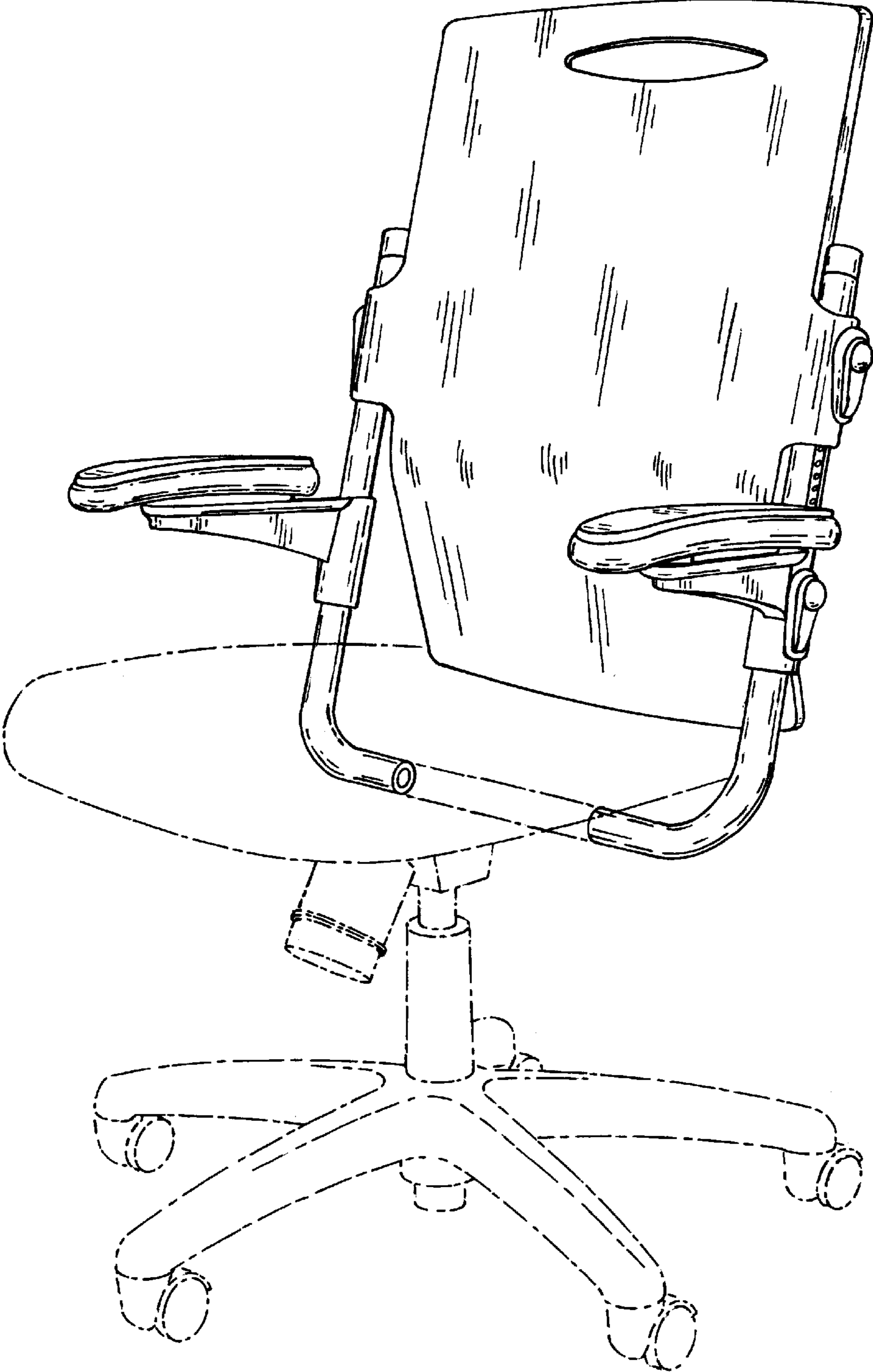

FIG. 1

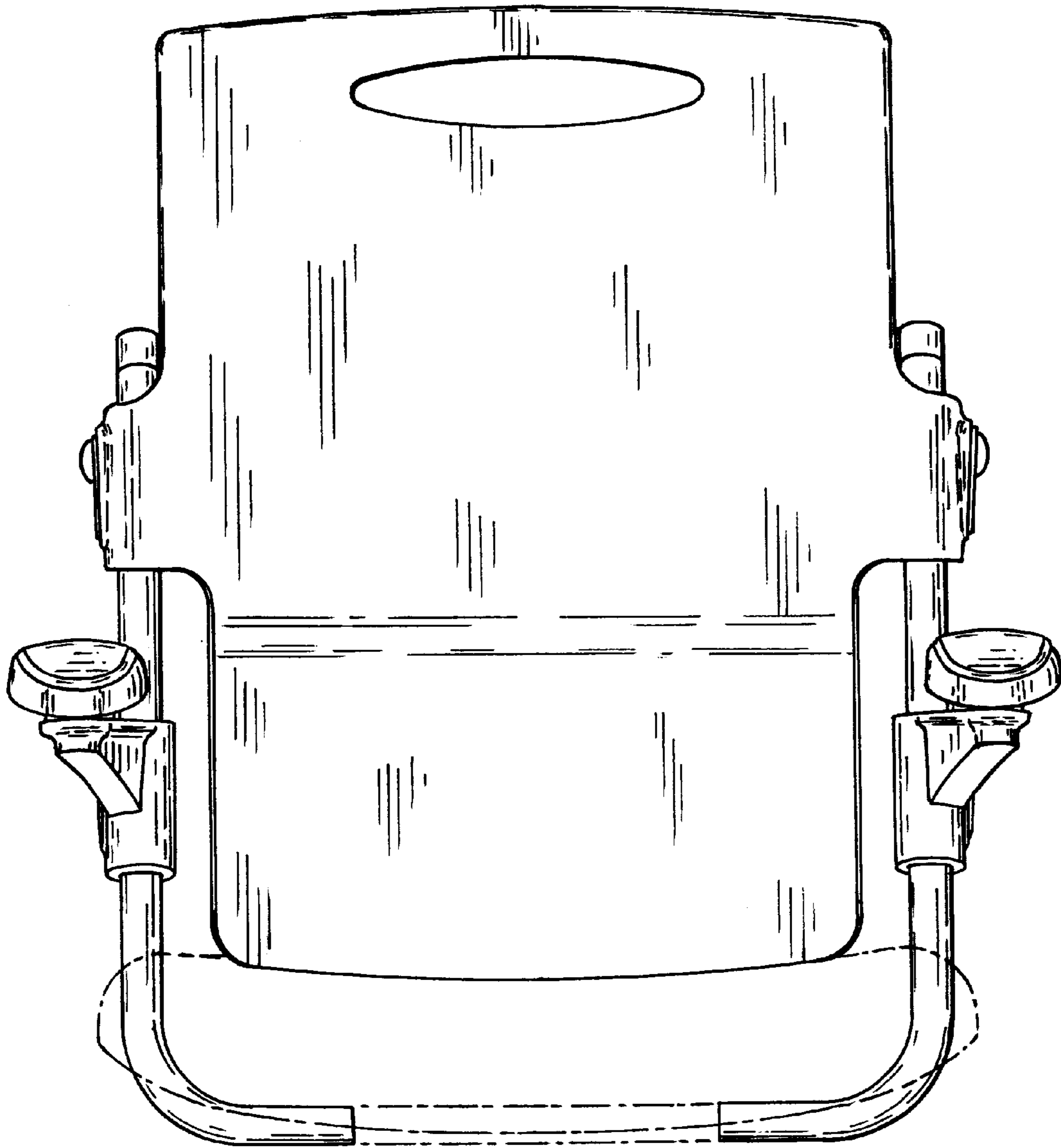

FIG. 2

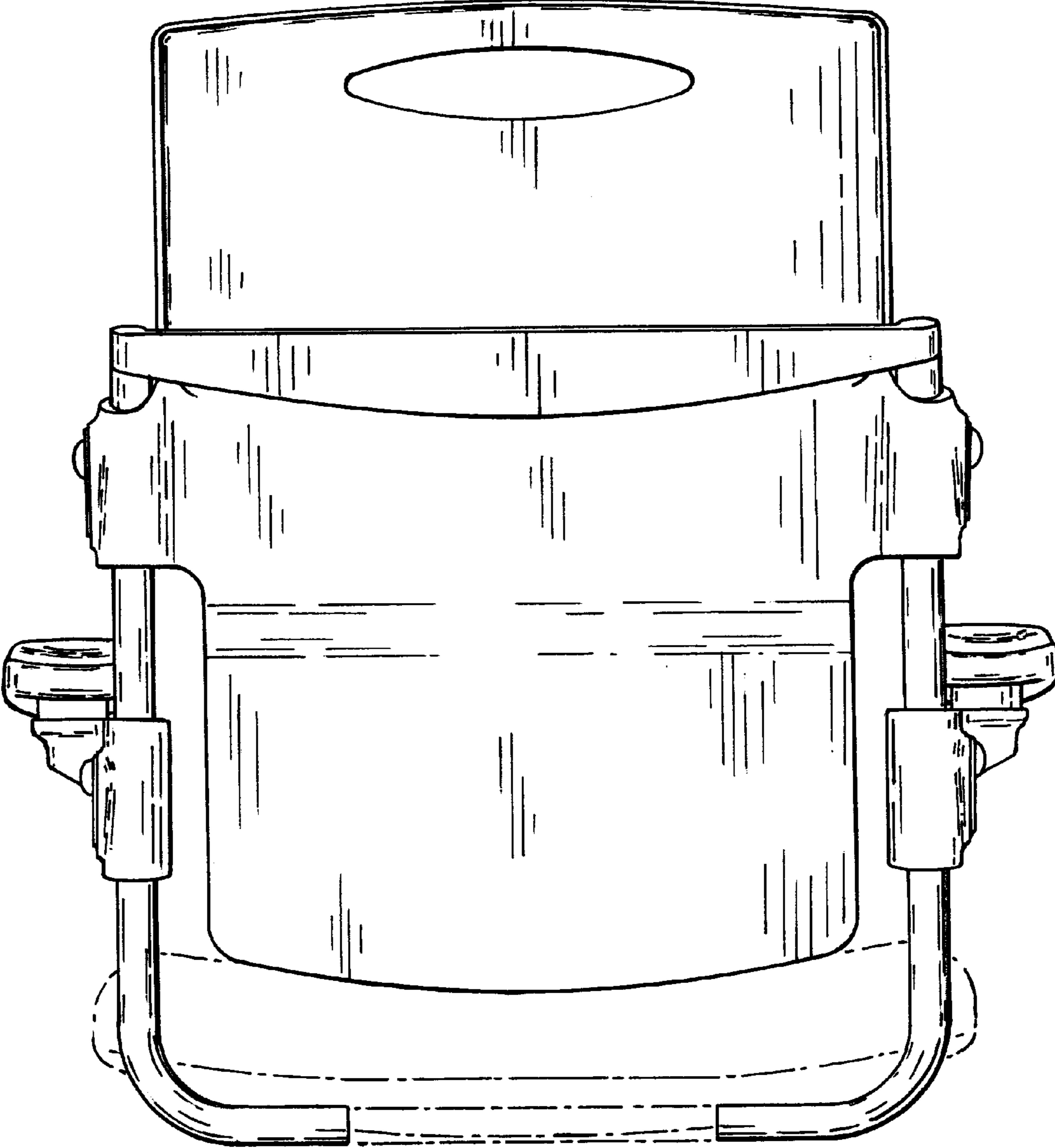

FIG. 3

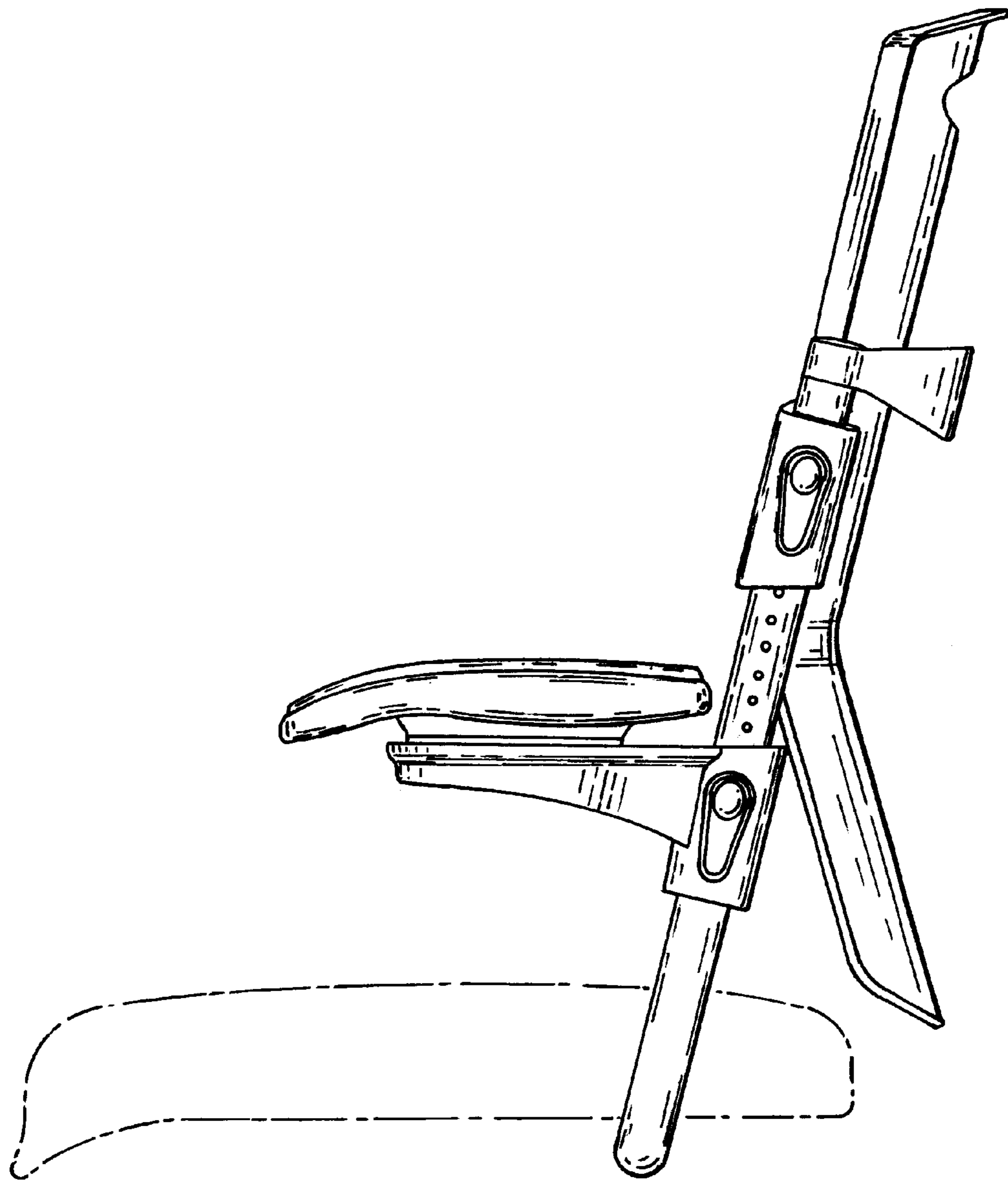

FIG. 4

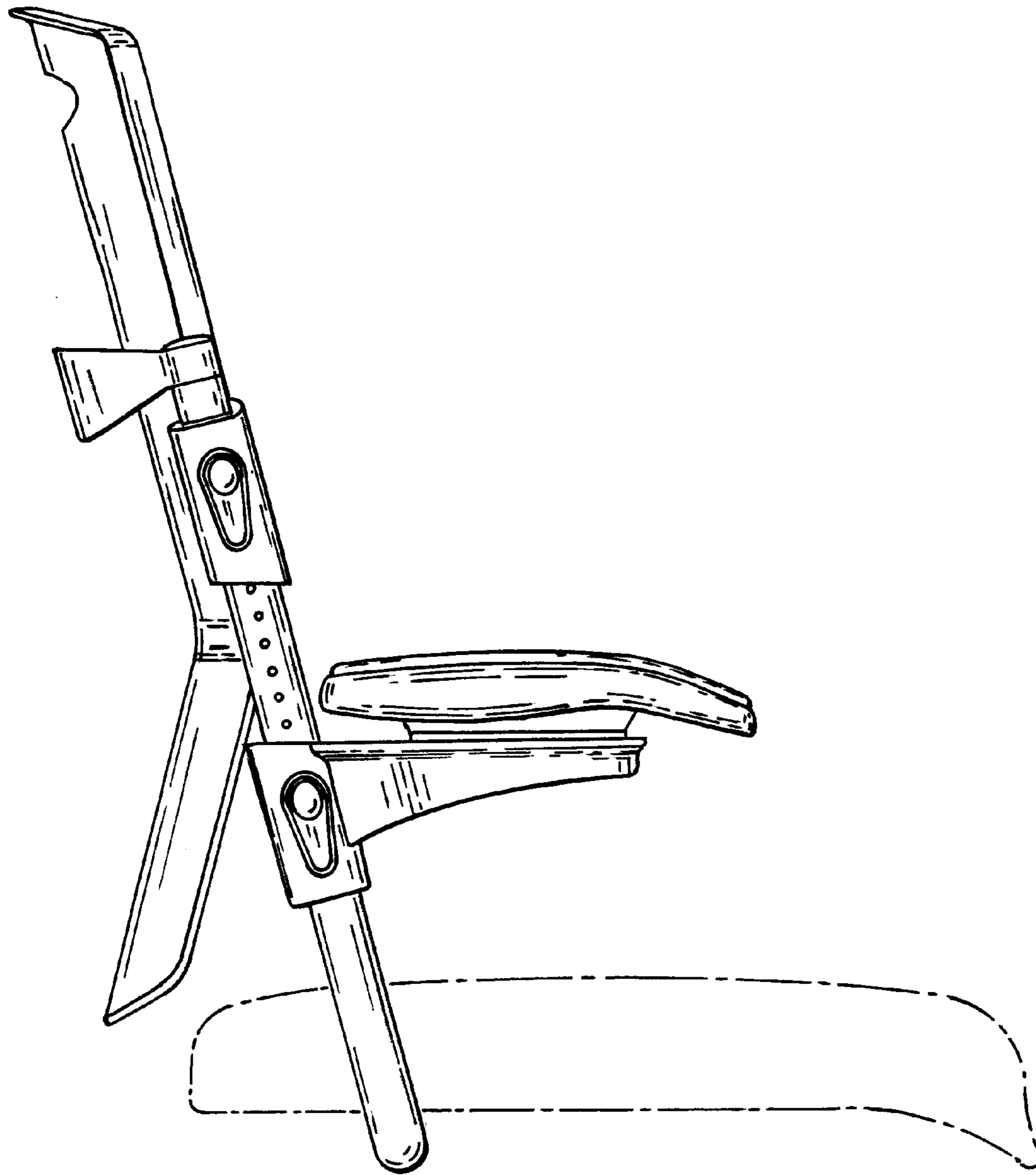

FIG. 5

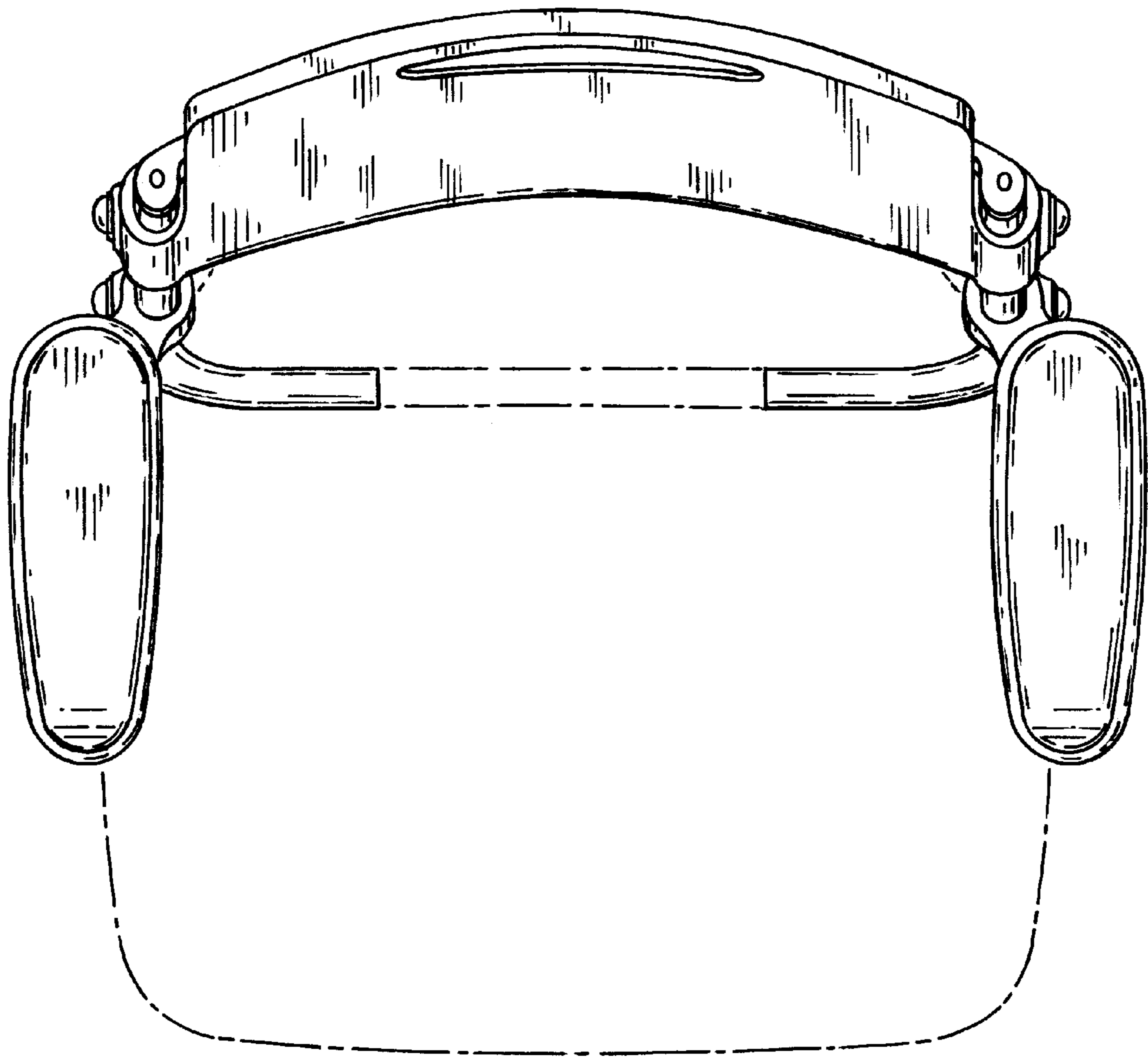

FIG. 6



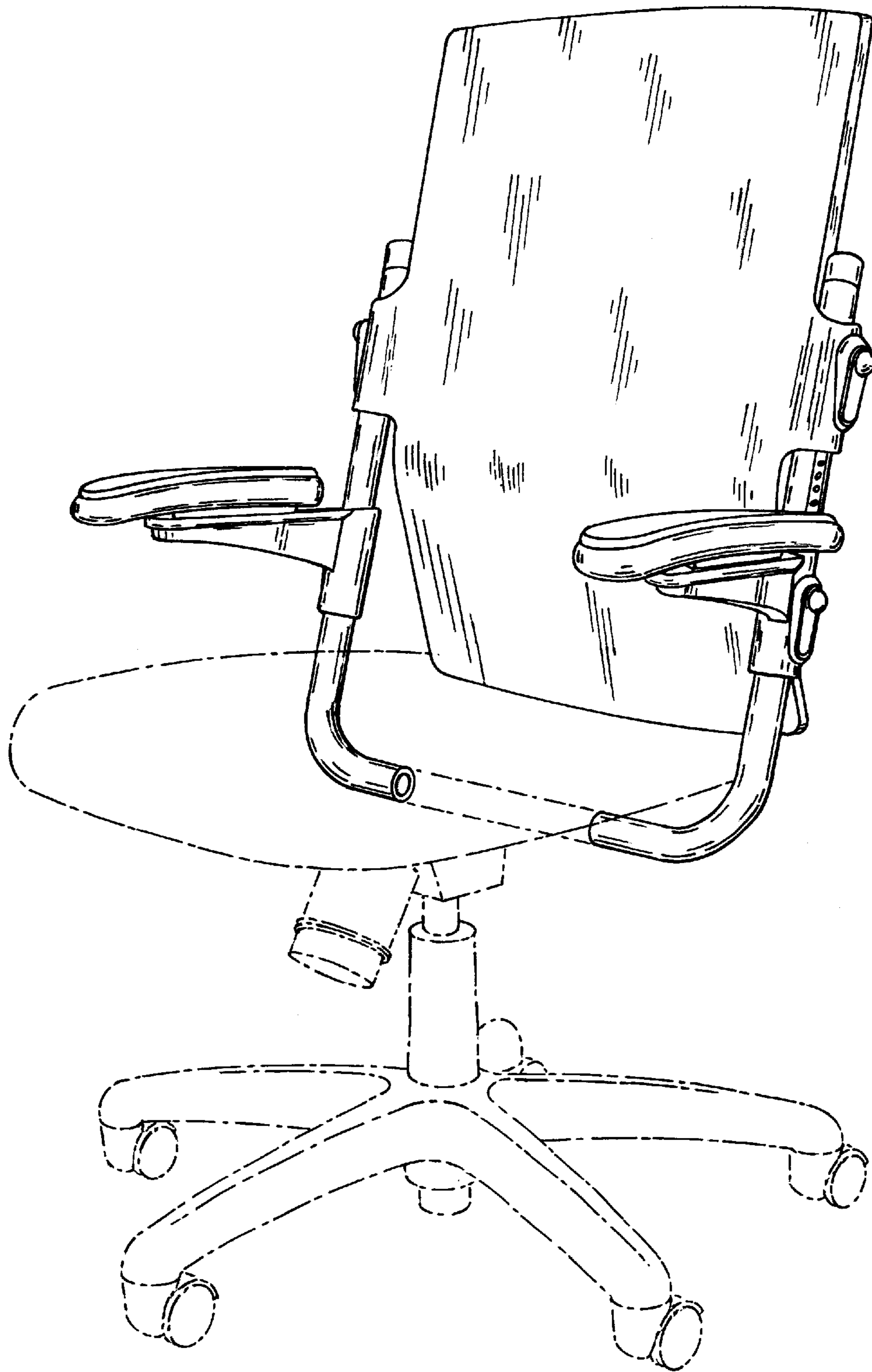

FIG. 7

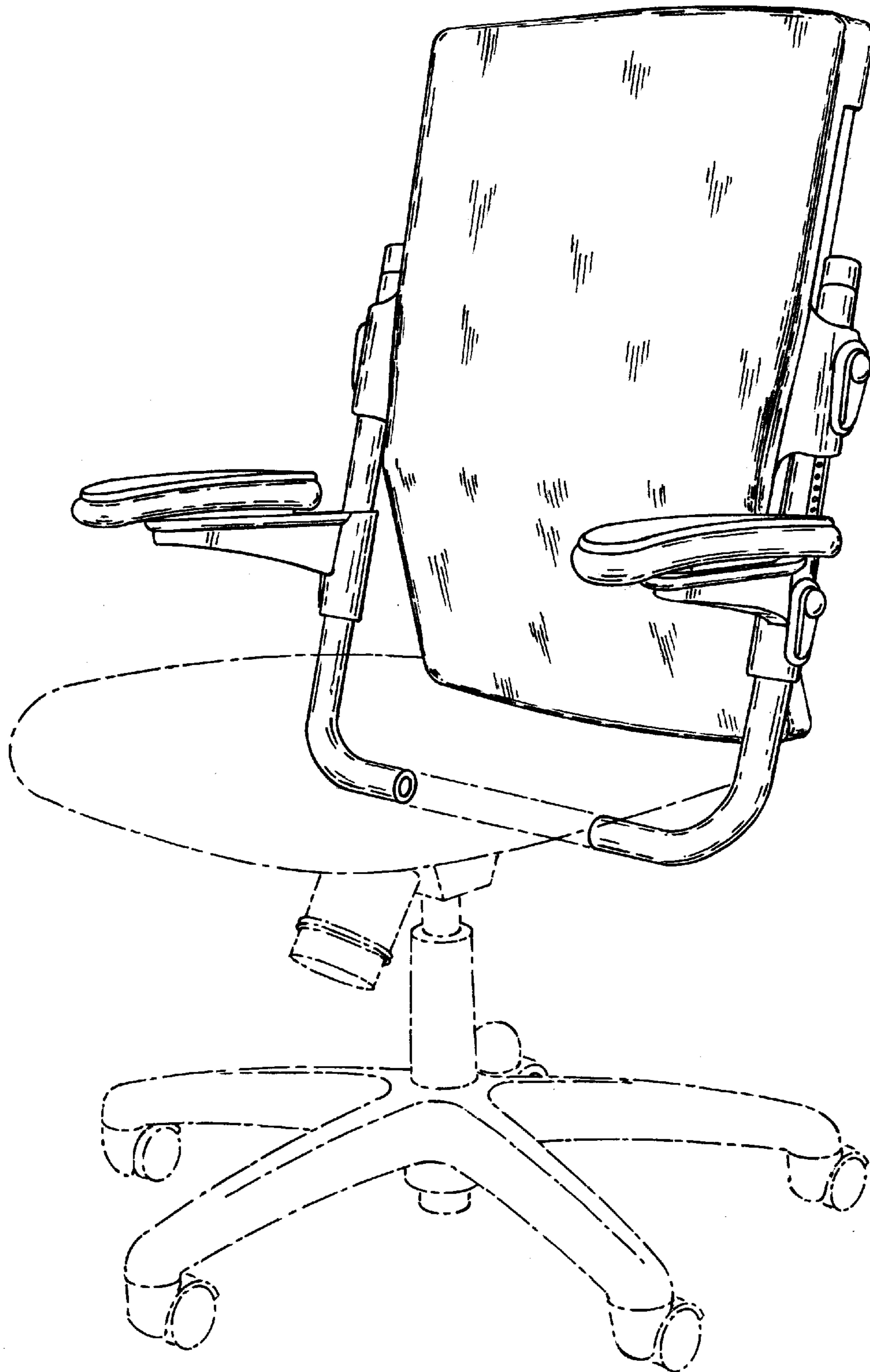

FIG. 8

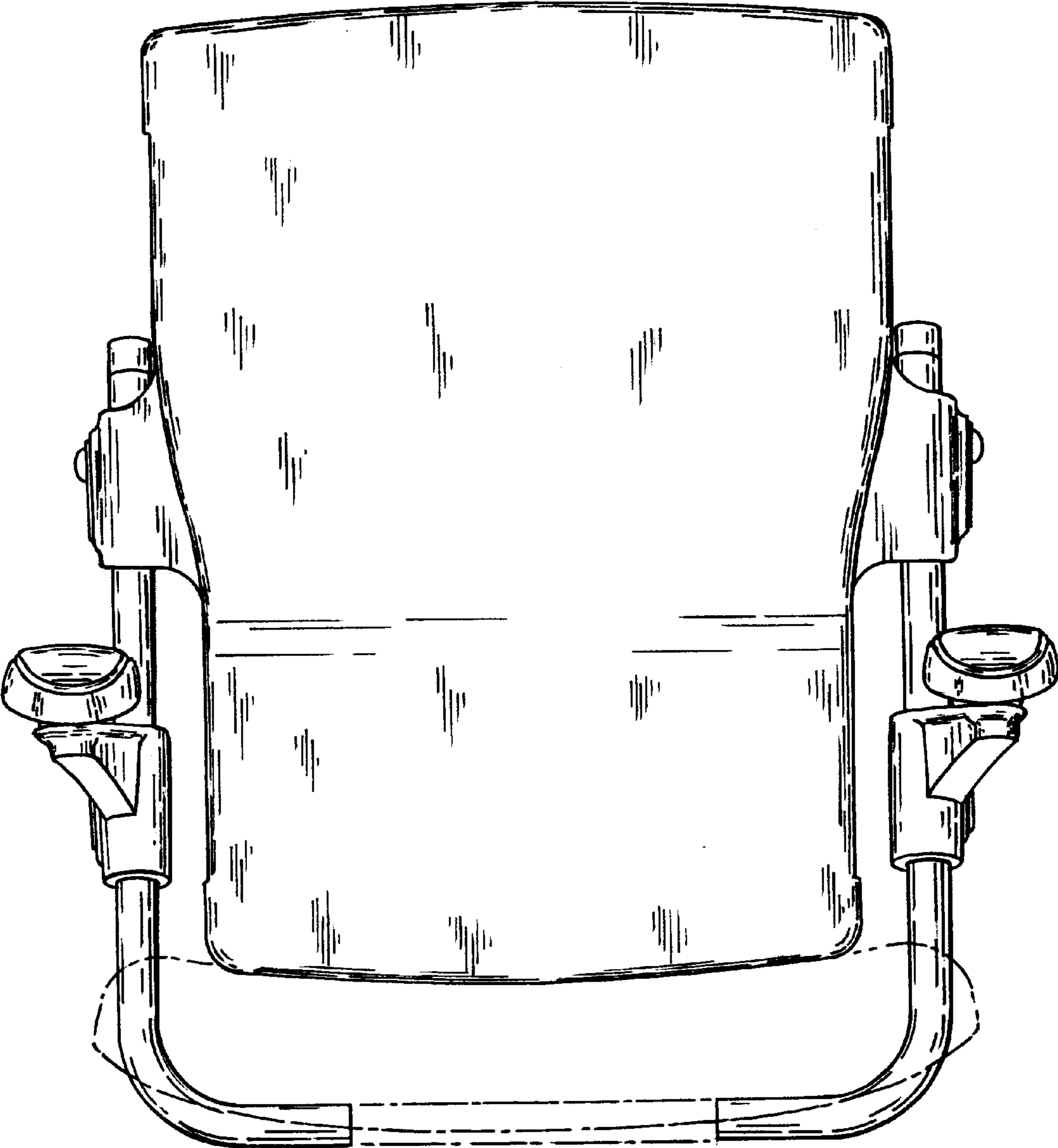

FIG. 9

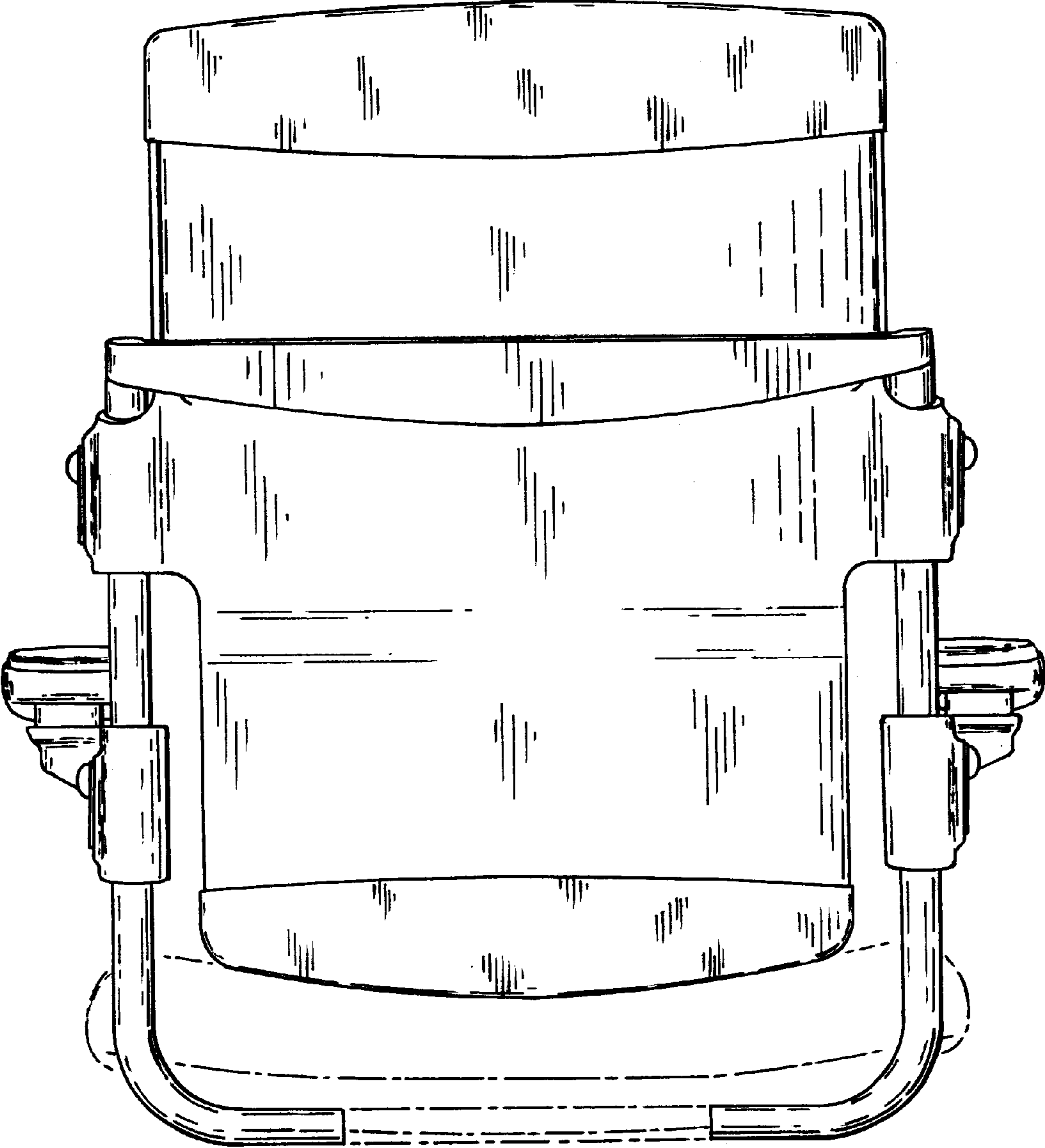

FIG. 10

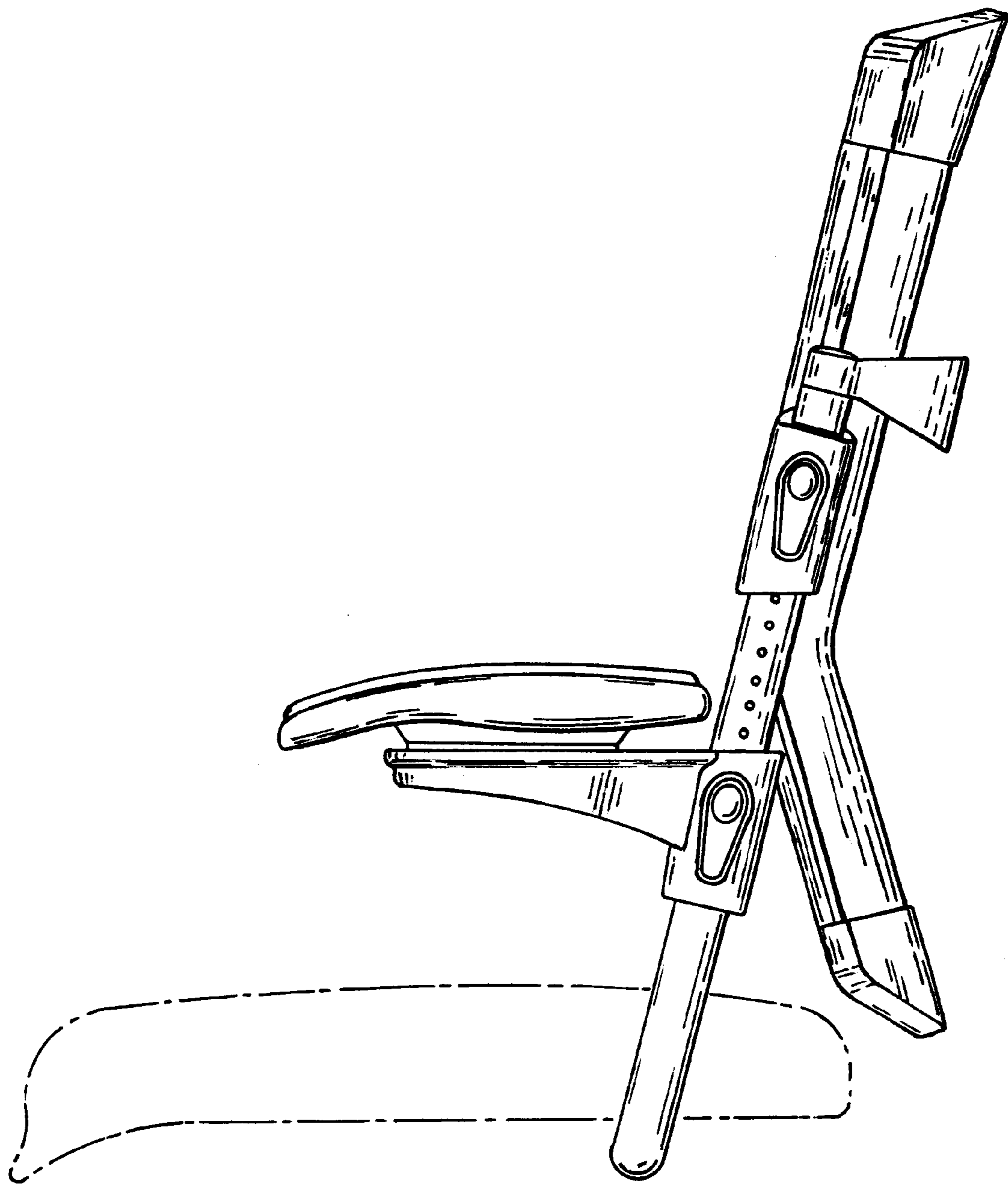

FIG. 11

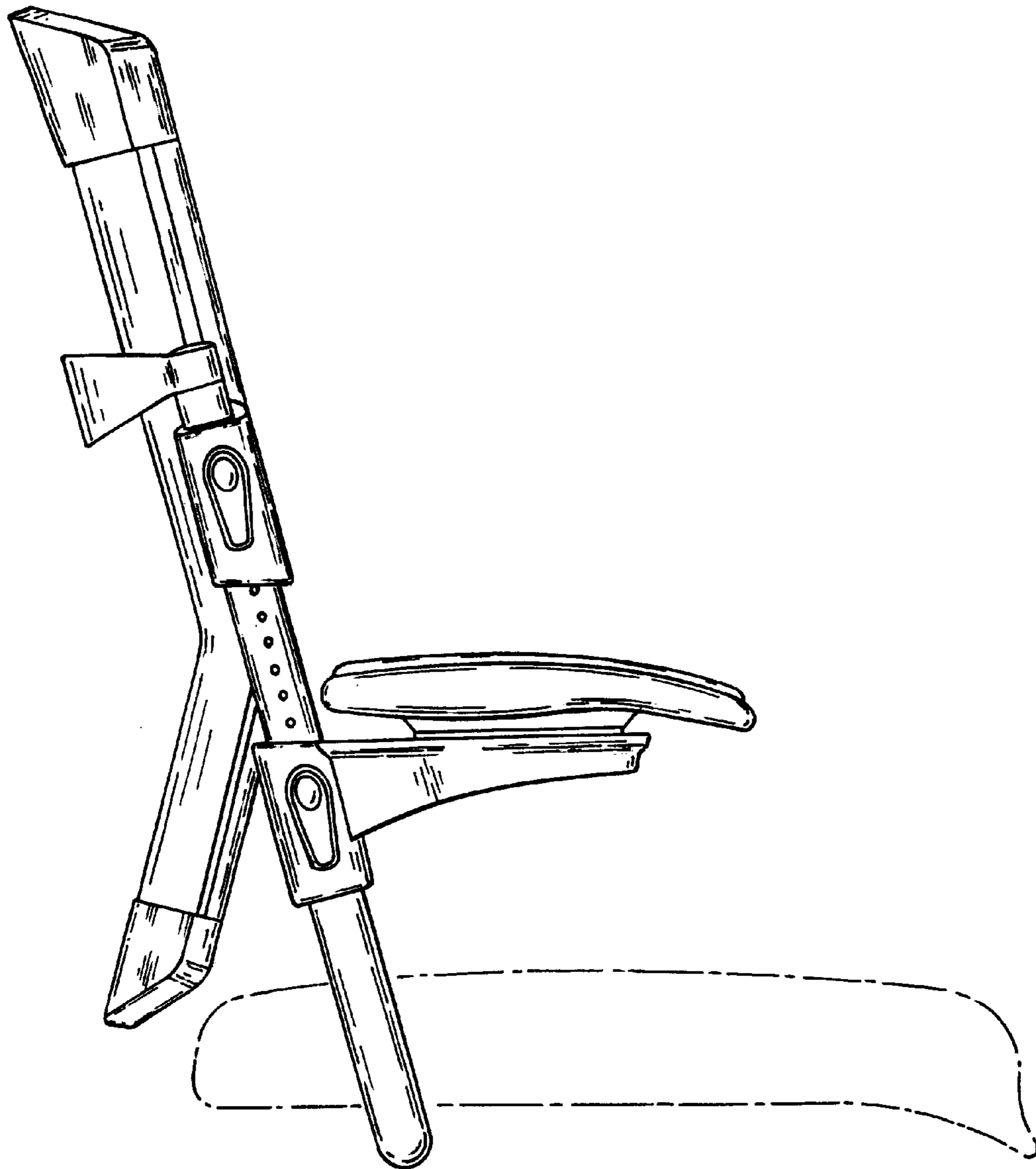

FIG.12

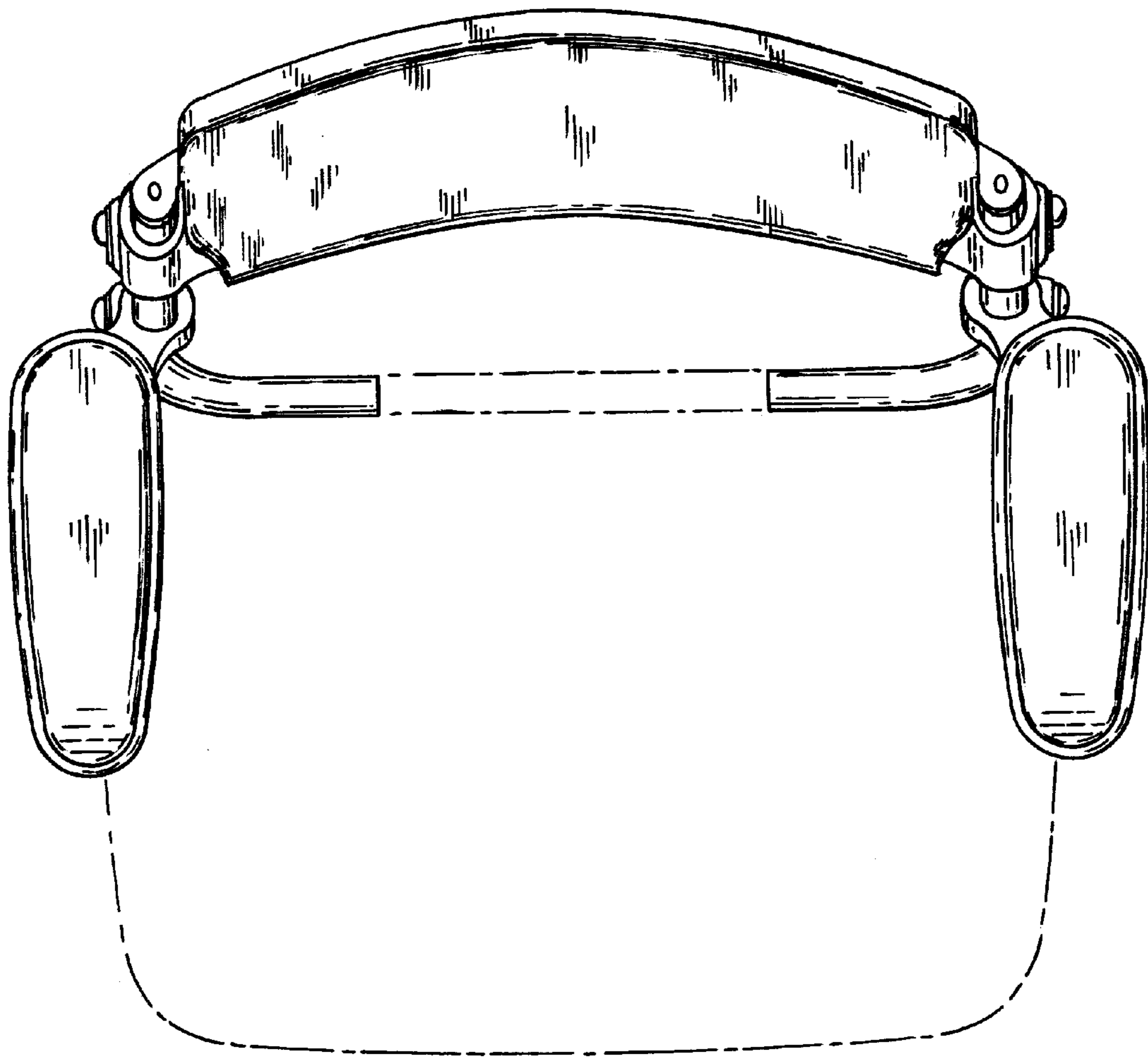

FIG. 13