

US00D507833S

(12) **United States Design Patent** (10) **Patent No.:** **US D507,833 S**  
**Coss** (45) **Date of Patent:** **\*\* Jul. 26, 2005**

(54) **NEEDLE STICK SHIELD**

(76) Inventor: **Ronald G. Coss**, 3 Overlook Dr.,  
Newport Coast, CA (US) 92657

(\*\*) Term: **14 Years**

(21) Appl. No.: **29/199,481**

(22) Filed: **Feb. 13, 2004**

(51) **LOC (8) Cl.** ..... **24-02**

(52) **U.S. Cl.** ..... **D24/130**

(58) **Field of Search** ..... D24/140, 130,  
D24/114; 604/194, 197, 198, 263, 187,  
192, 193; 128/919; D7/700; 206/363-365,  
367

(56) **References Cited**

**U.S. PATENT DOCUMENTS**

4,573,975	A	*	3/1986	Frist et al.	.....	604/192
D297,365	S	*	8/1988	Barnett	.....	D24/130
4,919,656	A	*	4/1990	Bracker et al.	.....	604/192
5,000,742	A	*	3/1991	Morrison	.....	604/192
D323,392	S	*	1/1992	Byrne	.....	D24/130
5,797,885	A	*	8/1998	Rubin	.....	604/192

**OTHER PUBLICATIONS**

ProTector™ Needle Puncture Guard/Sheath Prop, Certol®  
International, LLC.

ProTector™ Needle Sheath Prop, Disposable One-Handed  
Recapper, Mar. 2003, Certol® International, LLC.

Anaesthetic Syringes, [www.anthogy.com/instrument/contentu\\_seringue\\_qb.htm](http://www.anthogy.com/instrument/contentu_seringue_qb.htm); pp. 1-3.

\* cited by examiner

*Primary Examiner*—Ian Simmons

*Assistant Examiner*—Daniel Yu

(74) *Attorney, Agent, or Firm*—Knobbe, Martens Olson &  
Bear, LLP

(57) **CLAIM**

The ornamental design for a needle stick shield, as shown  
and described herein.

**DESCRIPTION**

FIG. 1 is a top perspective view of a needle stick shield  
showing the ornamental design.

FIG. 2 is a bottom perspective view thereof.

FIG. 3 is a bottom plan view thereof.

FIG. 4 is a top plan view thereof.

FIG. 5 is a side view taken along the line 5—5 in FIG. 3.

FIG. 6 is a perspective view thereof.

FIG. 7 is a perspective view thereof; and,

FIG. 8 is a side view taken along the line 8—8 in FIG. 3.

The broken line showing of the syringe body and cap is for  
illustrative purposes only and forms no part of the claimed  
design.

**1 Claim, 3 Drawing Sheets**

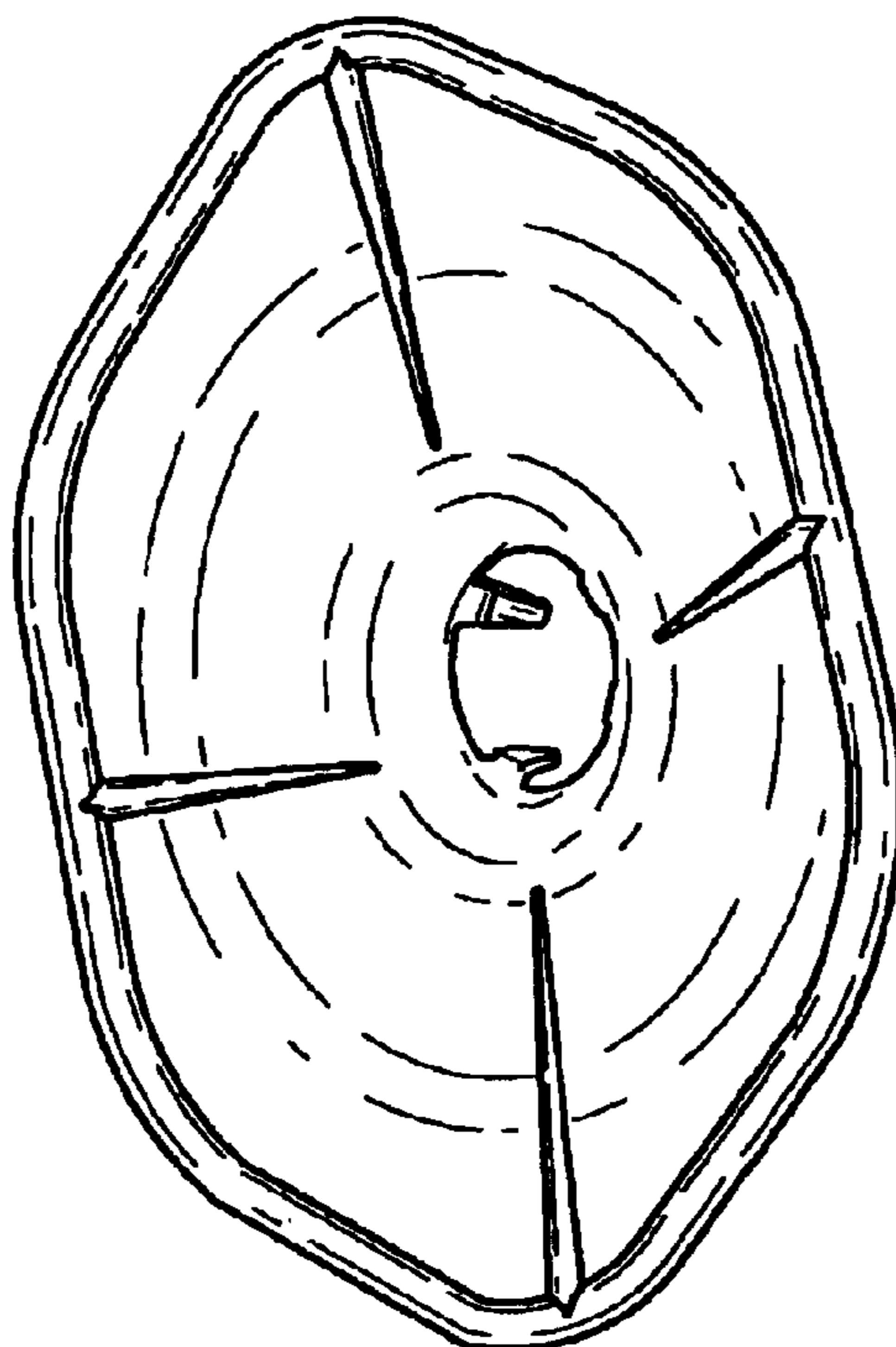

*FIG. 1*

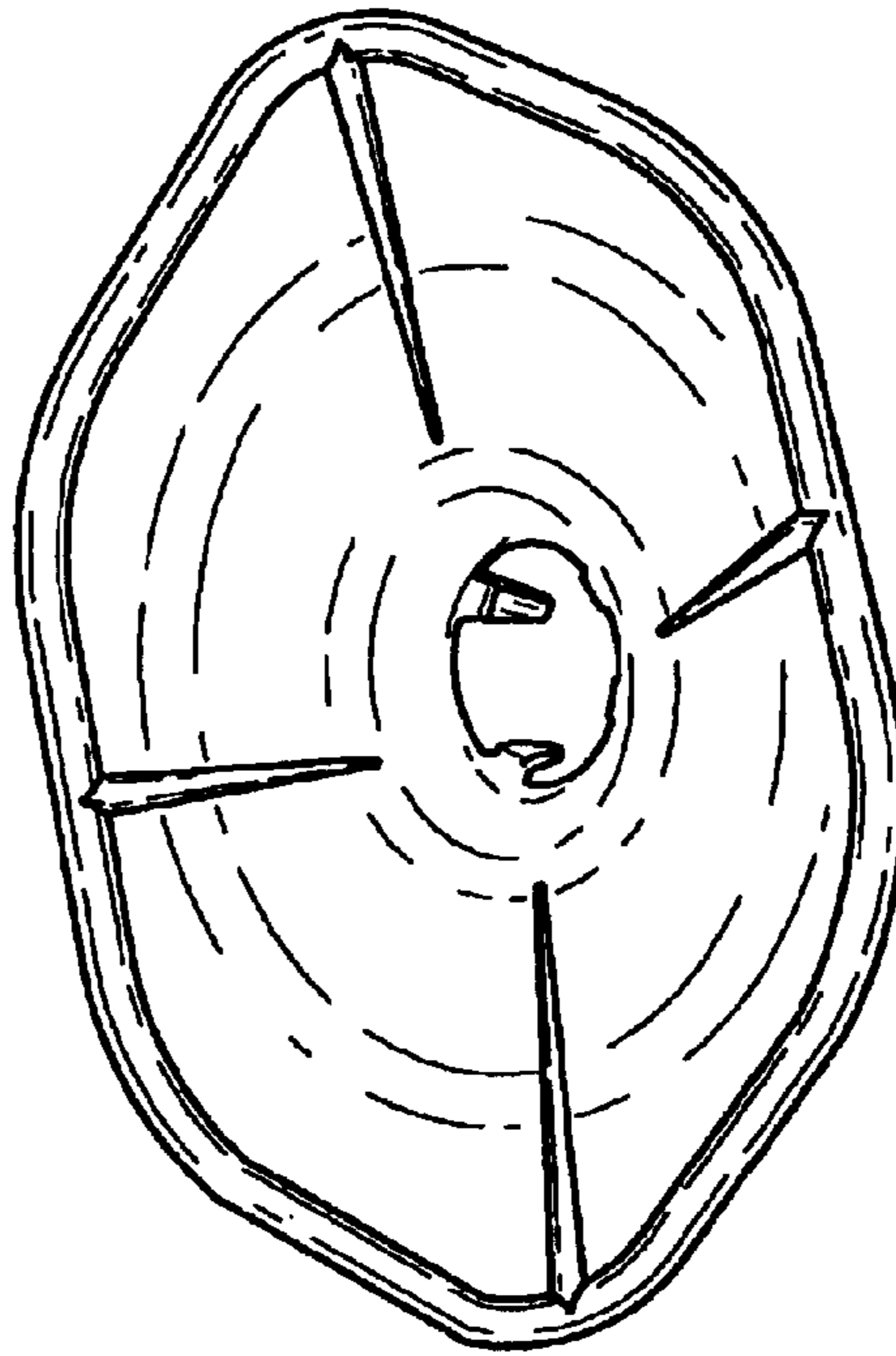

*FIG. 2*

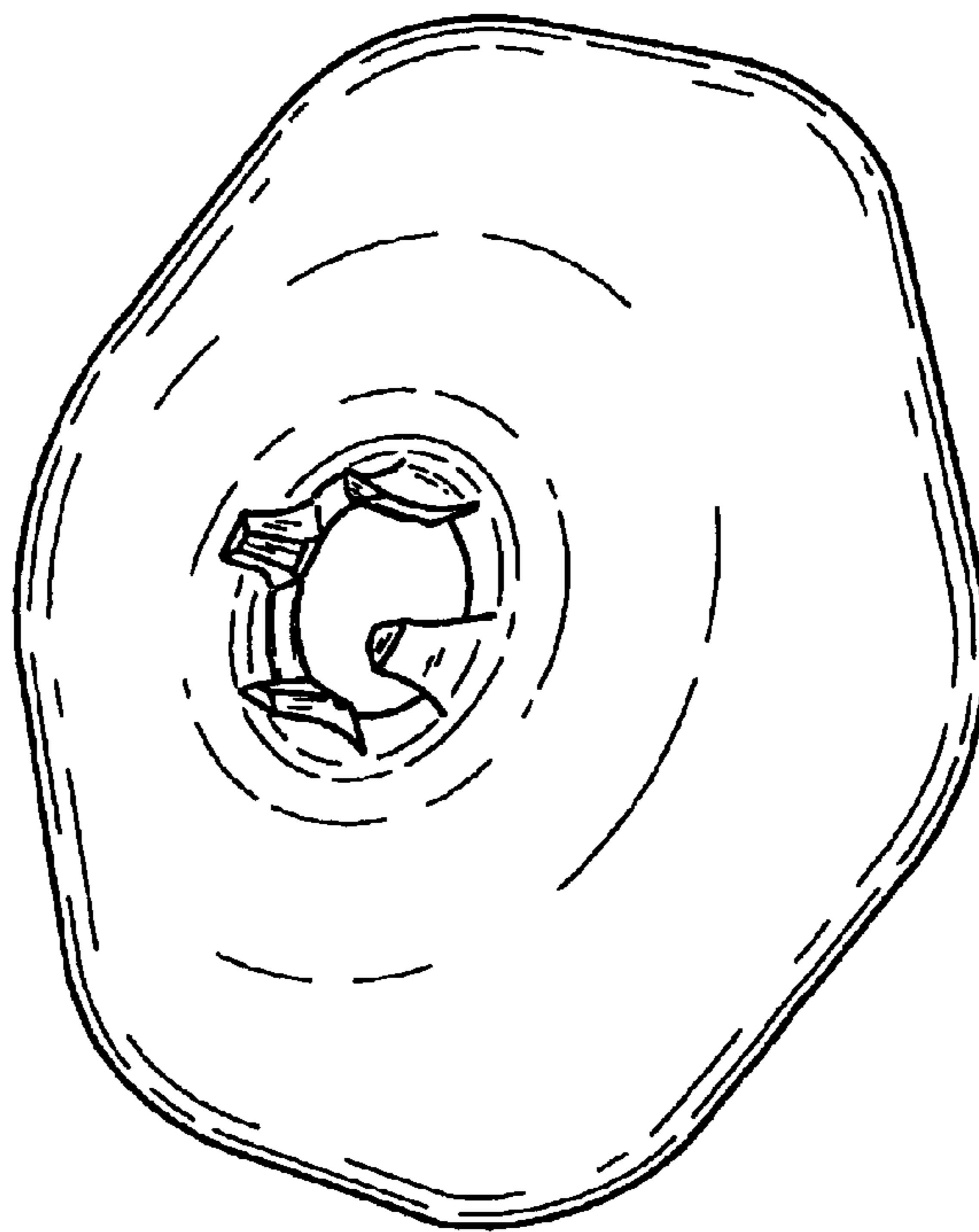

*FIG. 3*

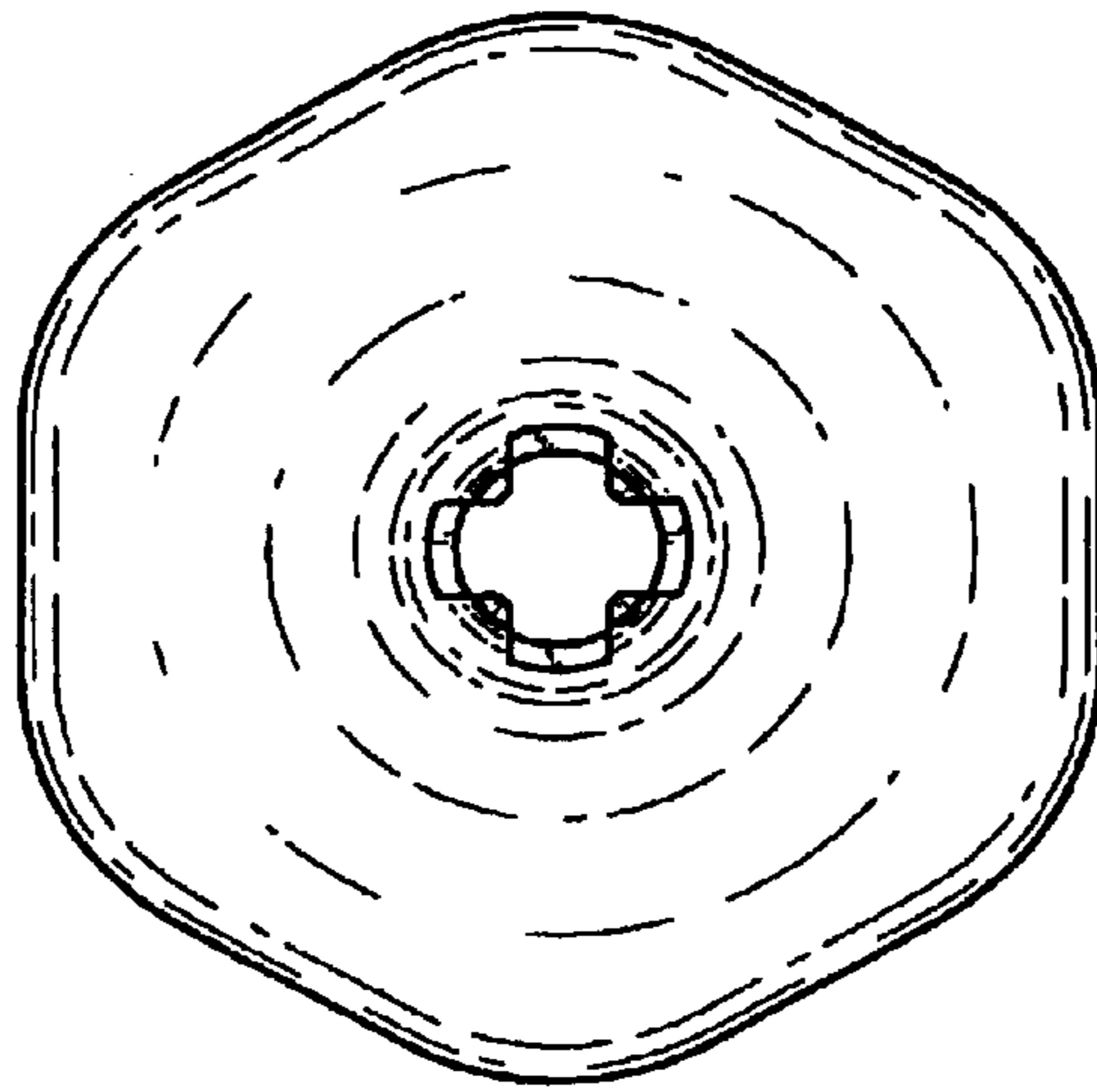

*FIG. 4*

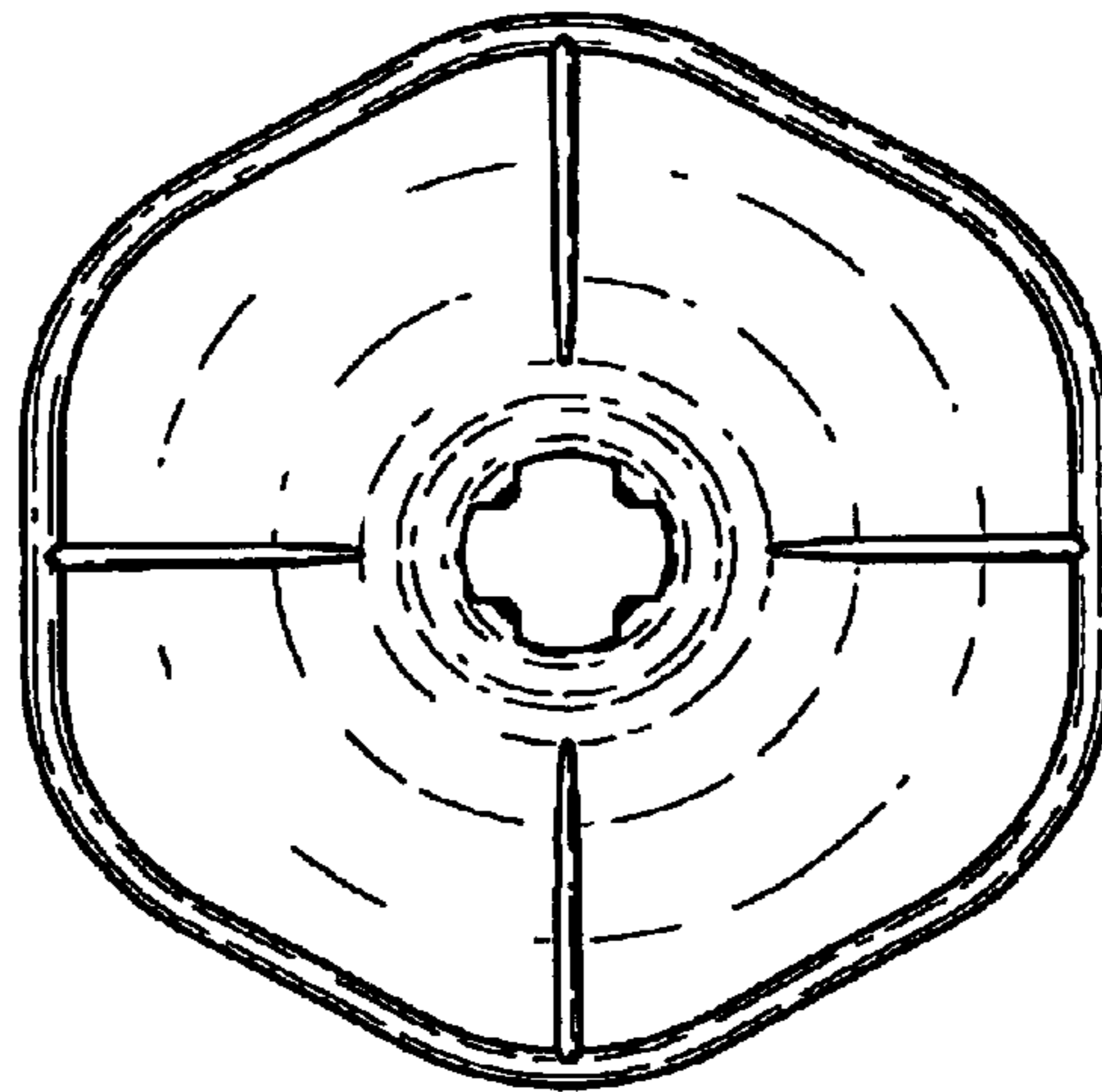
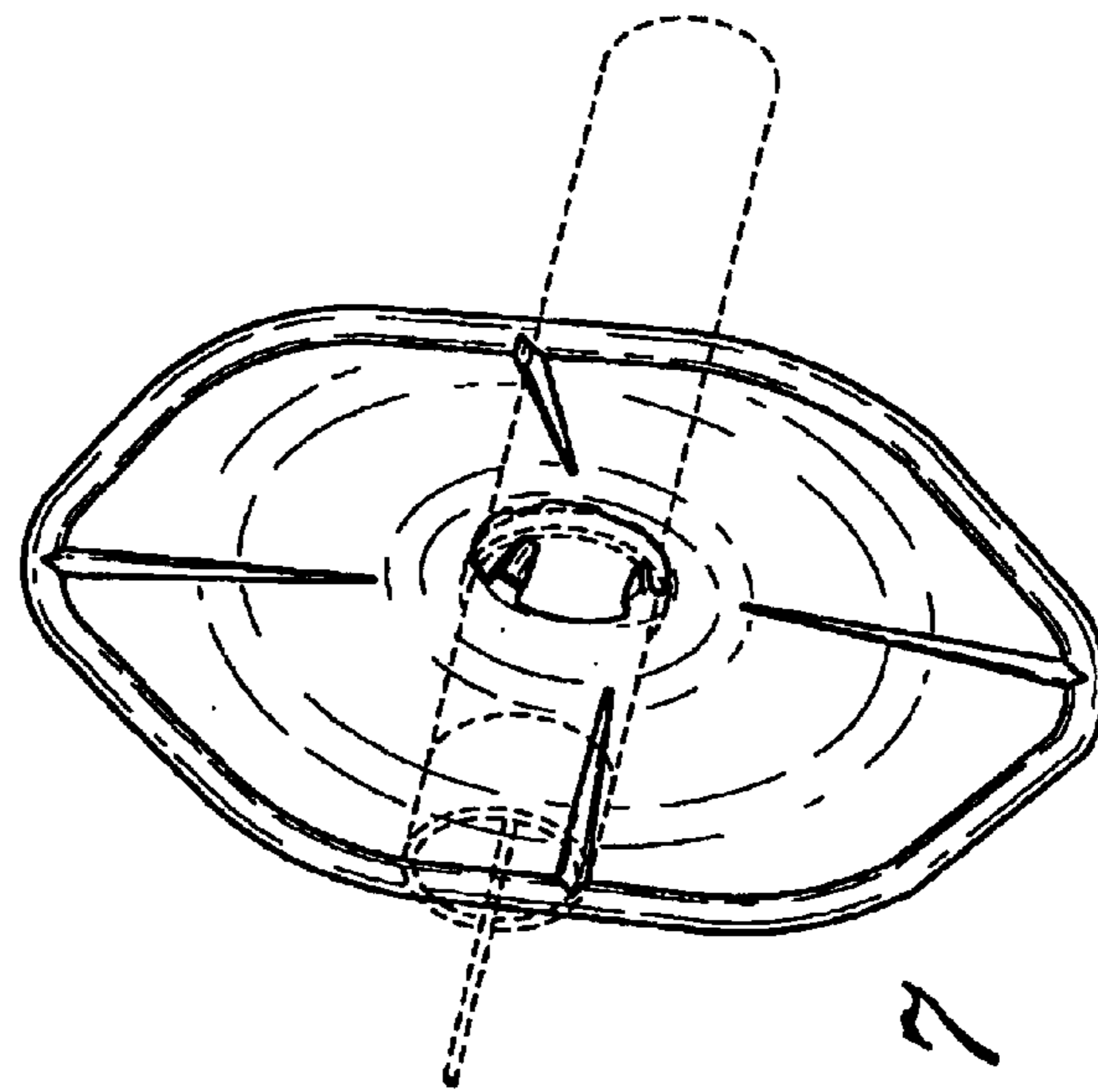
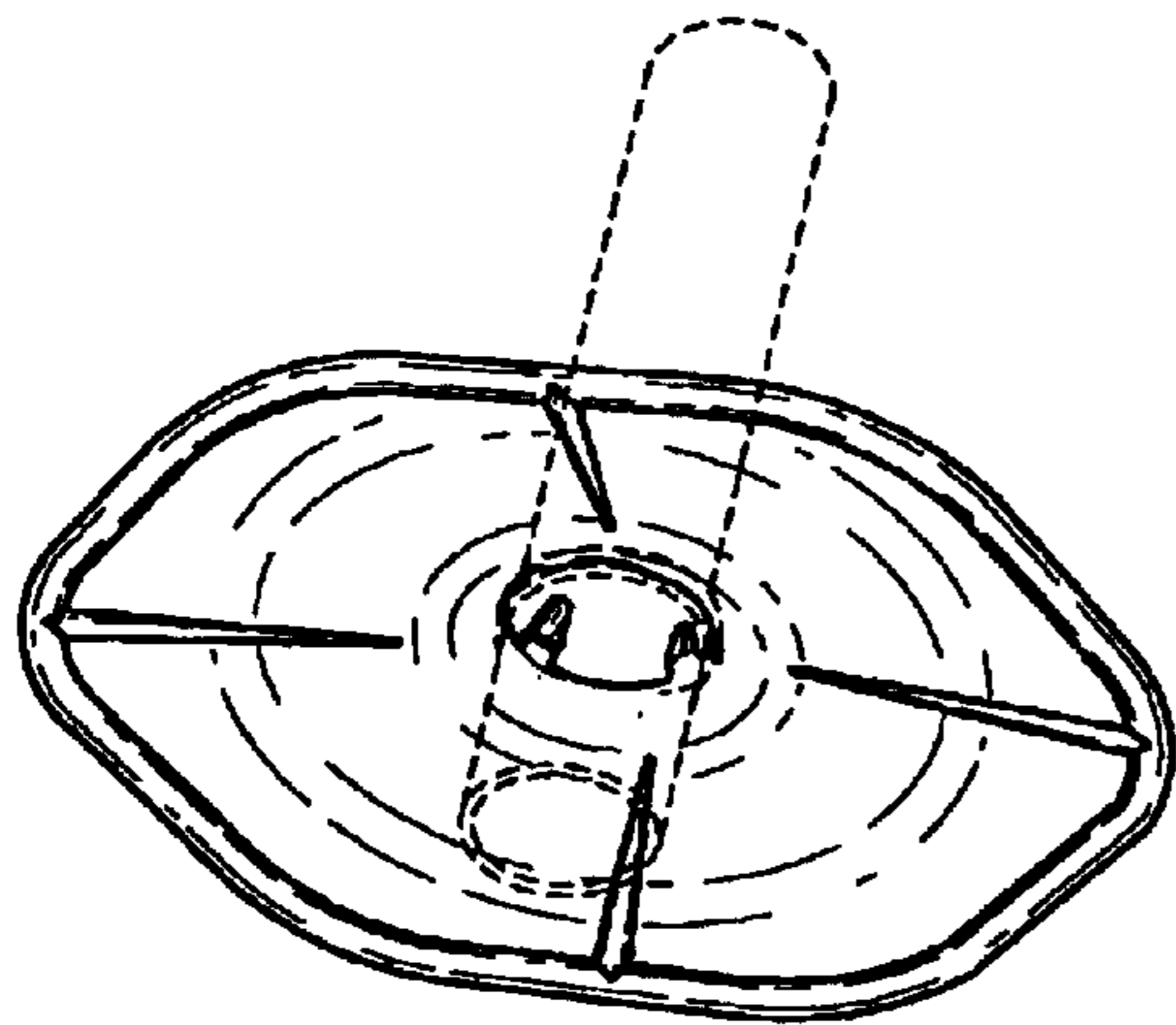

*FIG. 5*

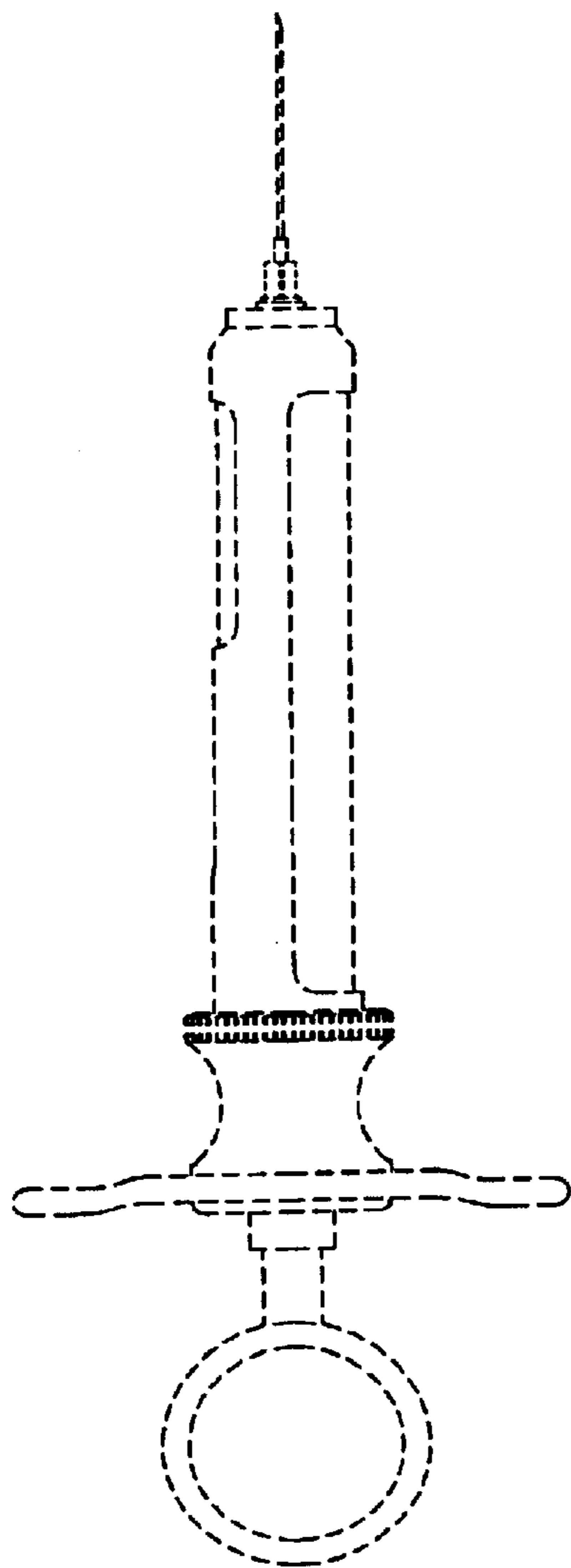

*FIG. 8*





*FIG. 7*



*FIG. 6*