

US00D507821S

(12) **United States Design Patent**
Colpitts et al.

(10) **Patent No.: US D507,821 S**

(45) **Date of Patent: ** Jul. 26, 2005**

(54) **COMBINED SINK BASKET AND SINK BASKET STRAINER**

D441,848 S * 5/2001 Huang D23/261
D454,177 S 3/2002 Tracy

(75) Inventors: **Peter Colpitts, Uxbridge (CA); Scott Nelson, Uxbridge (CA)**

* cited by examiner

(73) Assignee: **Martin Tracy, Ontario (CA)**

Primary Examiner—Robin V. Taylor

(**) Term: **14 Years**

(74) *Attorney, Agent, or Firm*—Merek, Blackmon & Voorhees, LLC

(21) Appl. No.: **29/202,412**

(57) **CLAIM**

(22) Filed: **Mar. 31, 2004**

The ornamental design for a combined sink basket and sink basket strainer, as shown and described.

(30) **Foreign Application Priority Data**

DESCRIPTION

Jan. 20, 2004 (CA) 105623

FIG. 1 is an upper side perspective view of the combined sink basket and sink basket strainer according to our new design;

(51) **LOC (8) Cl.** **23-01**

FIG. 2 is a plan view thereof;

(52) **U.S. Cl.** **D23/261**

FIG. 3 is a side elevational view thereof;

(58) **Field of Search** D23/261; 4/679, 4/286, 290, 292, 289; 210/164

FIG. 4 is a bottom view thereof;

FIG. 5 is a side perspective view of the combined sink basket and sink basket strainer with the plug portion elevated; and, FIG. 6 is a lower side perspective view of the combined sink basket and sink basket strainer with the plug portion elevated.

(56) **References Cited**

U.S. PATENT DOCUMENTS

3,800,339 A * 4/1974 Bergin 4/287

3,982,289 A 9/1976 Robbins

4,320,540 A 3/1982 Leavens

1 Claim, 6 Drawing Sheets

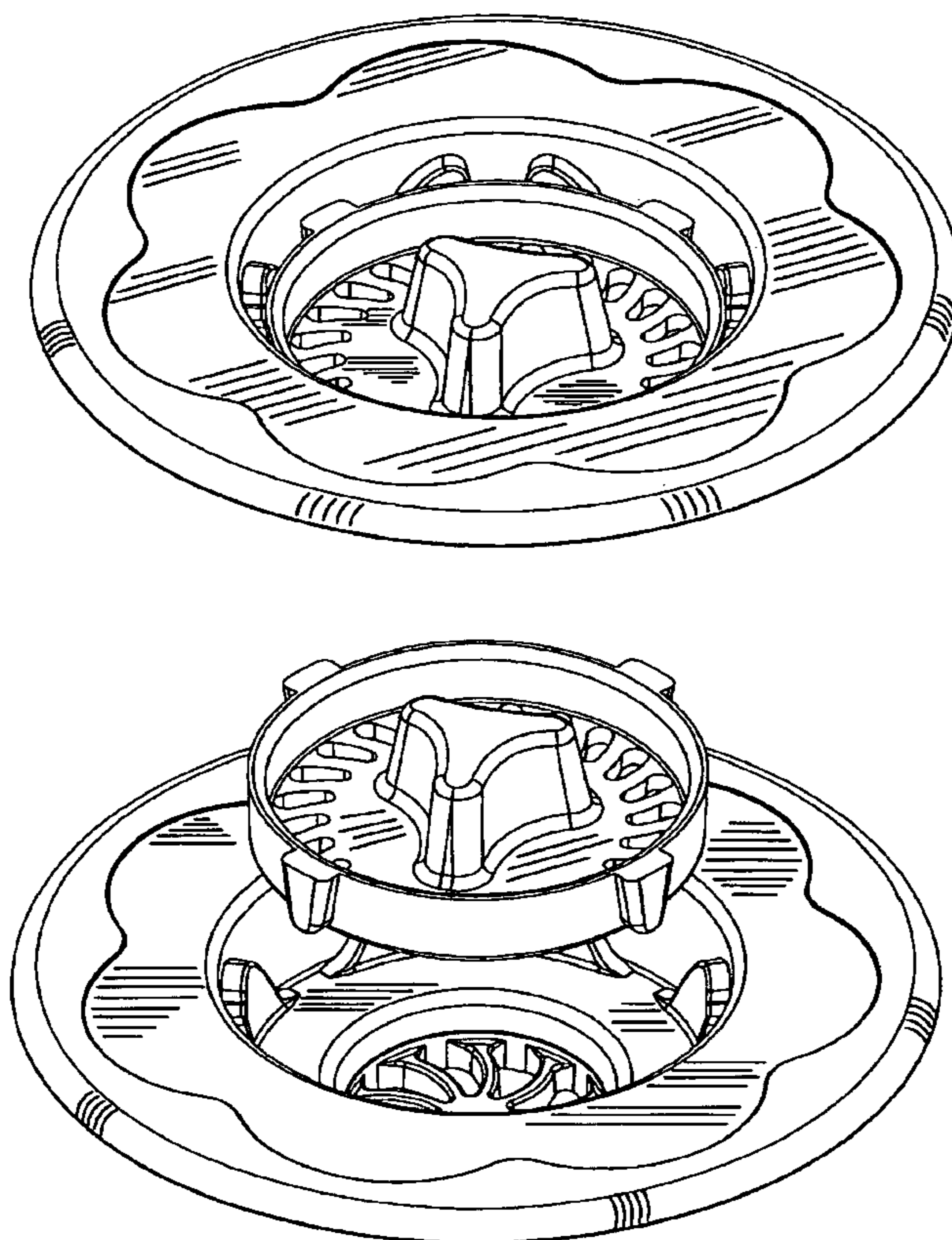

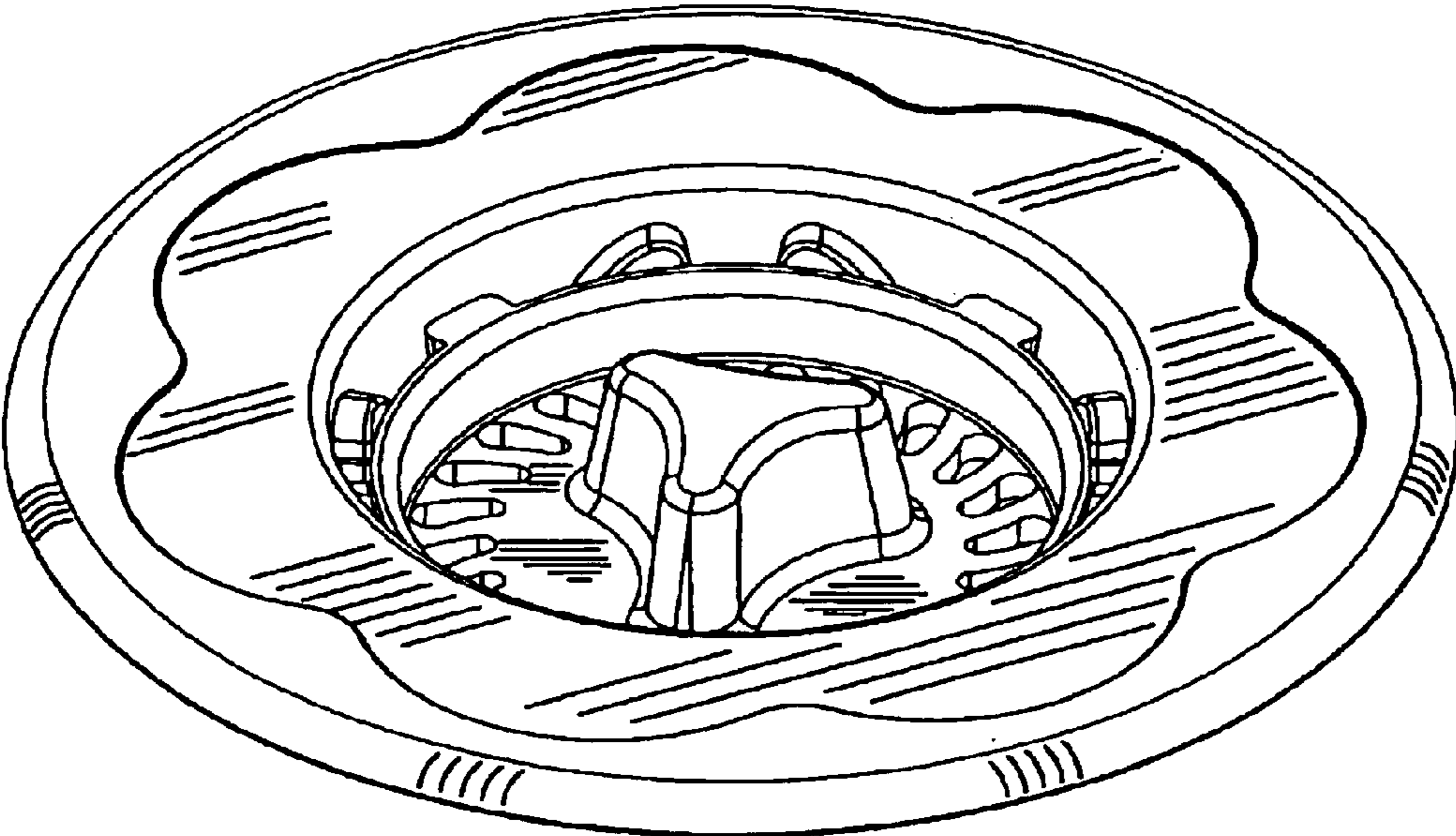

FIG. 1

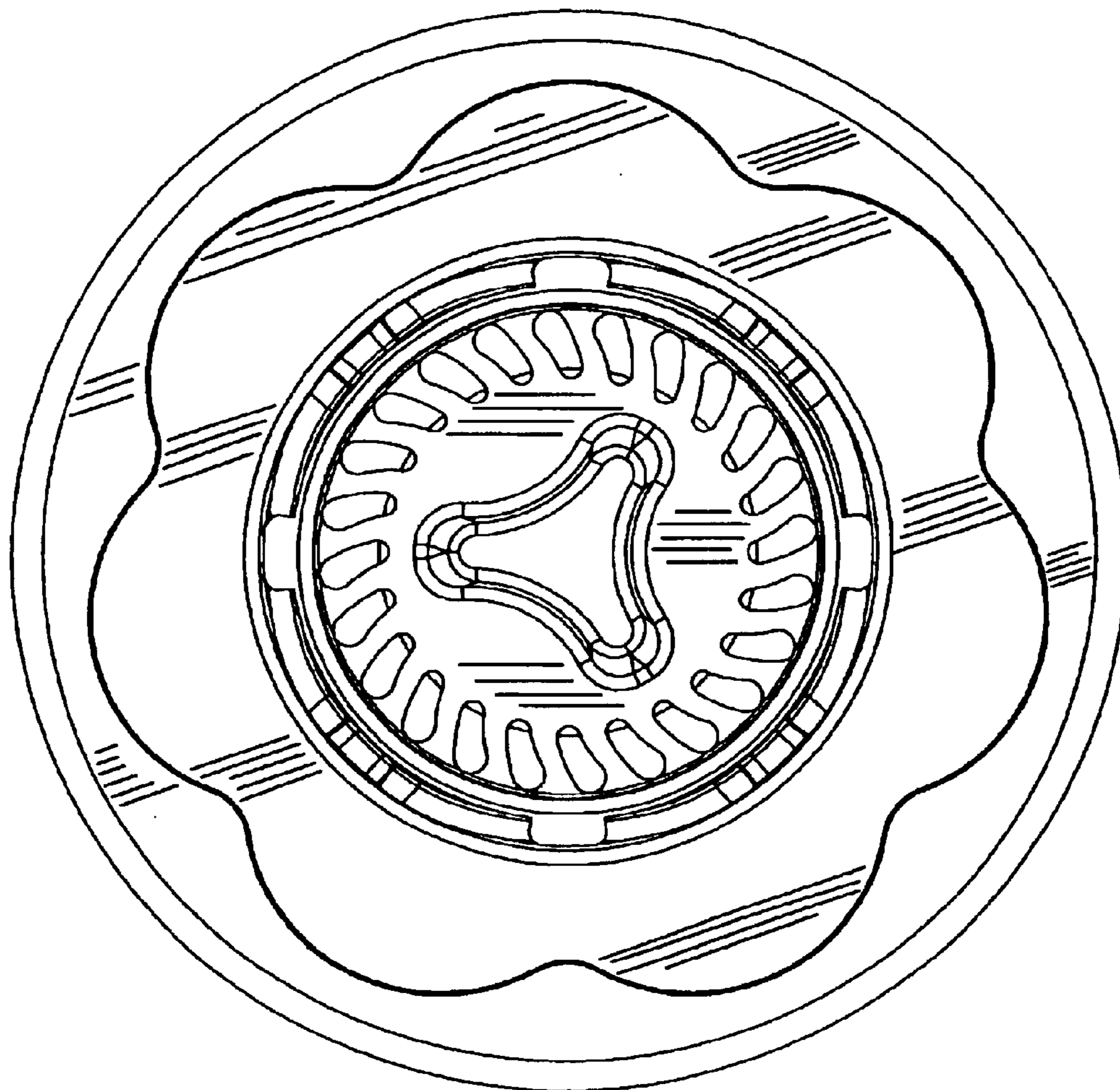

FIG. 2

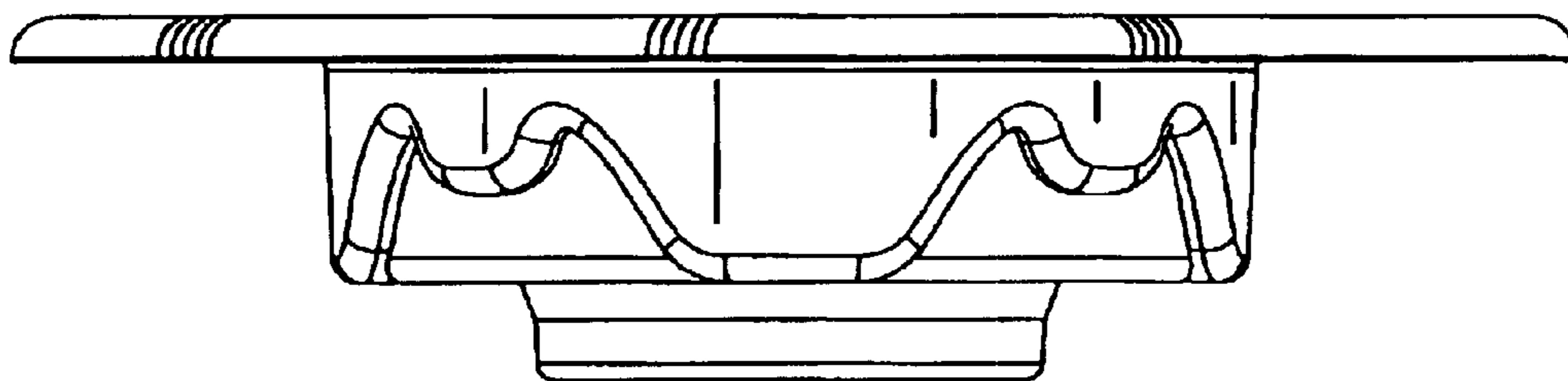

FIG. 3

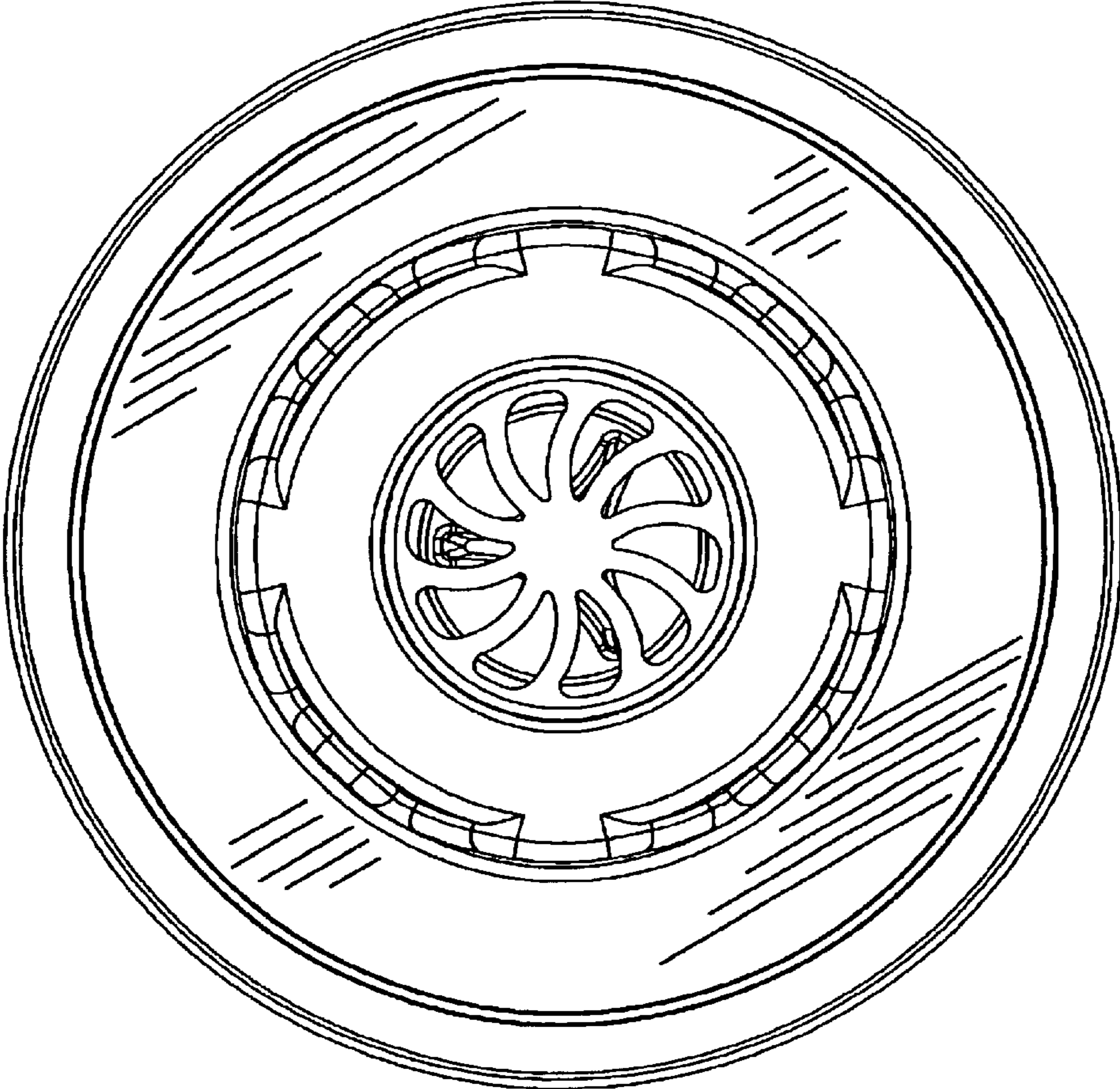

FIG. 4

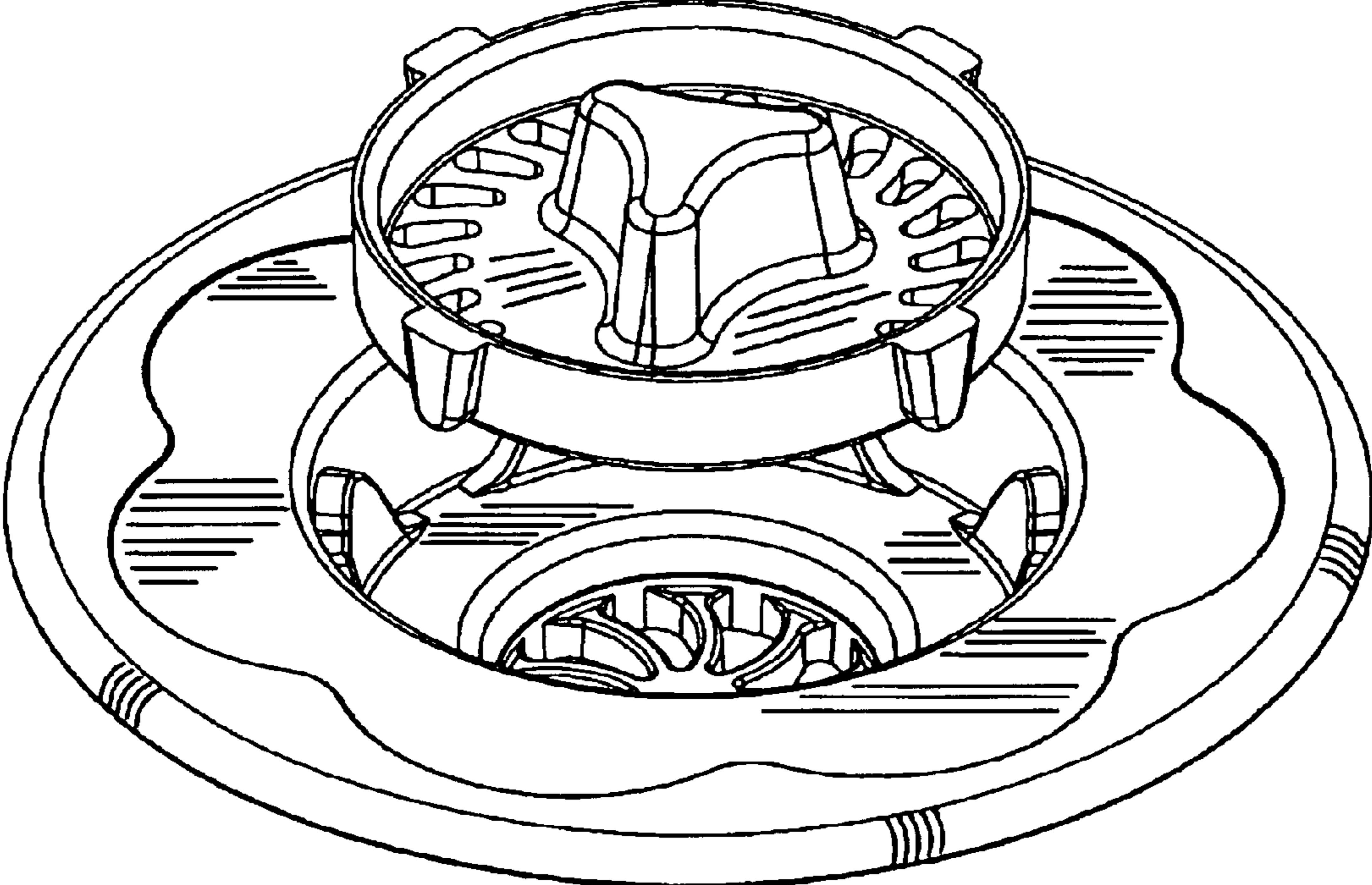

FIG. 5

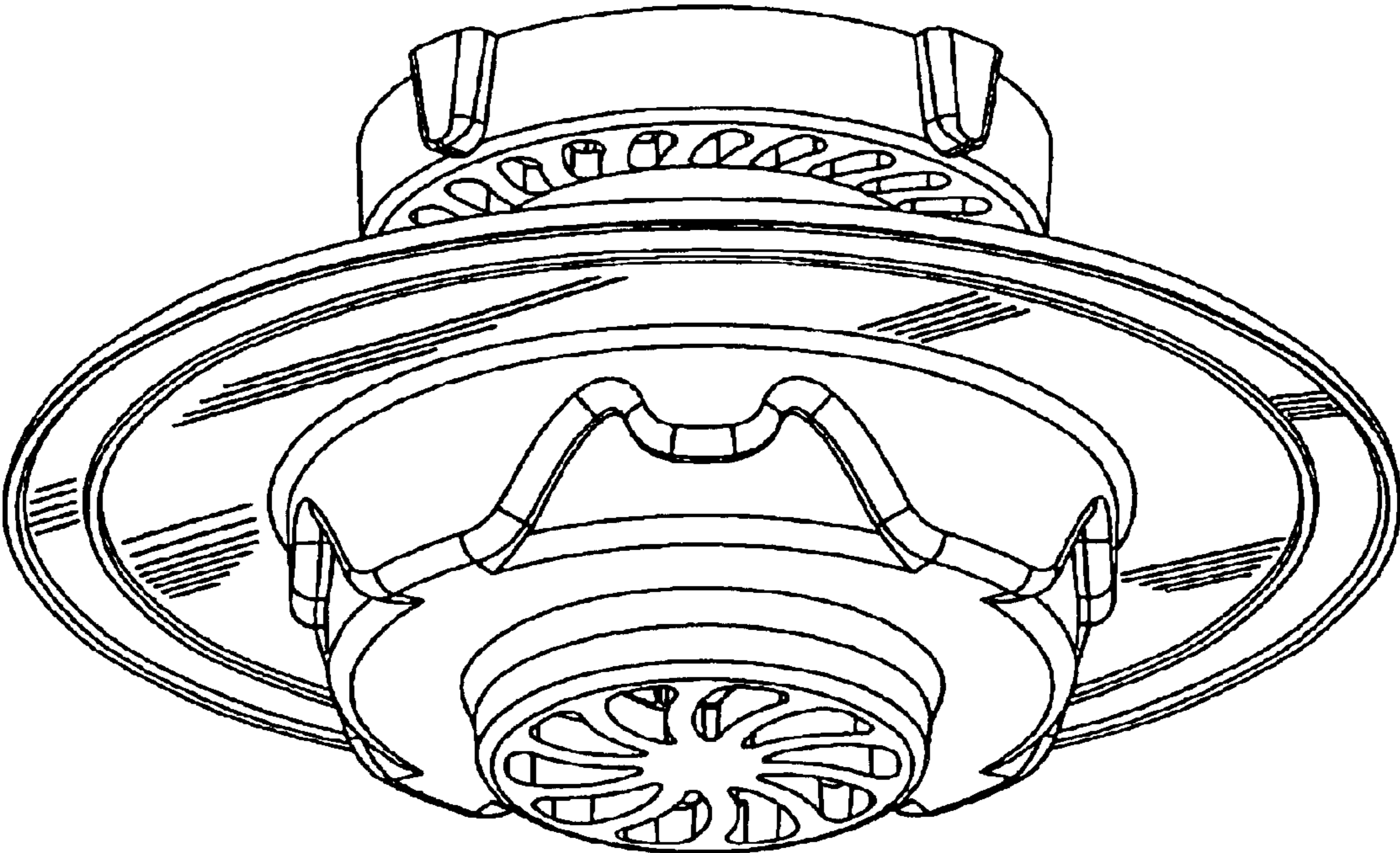

FIG. 6