



US00D507615S

(12) **United States Design Patent**
Imamoto

(10) **Patent No.:** **US D507,615 S**
(45) **Date of Patent:** **** Jul. 19, 2005**

(54) **WOOD GOLF HEAD**

(75) Inventor: **Yasunori Imamoto**, Tokyo (JP)

(73) Assignee: **Bridgestone Sports Co., Ltd.**, Tokyo (JP)

(**) Term: **14 Years**

(21) Appl. No.: **29/193,195**

(22) Filed: **Nov. 6, 2003**

(30) **Foreign Application Priority Data**

May 16, 2003 (JP) 2003-013556
Sep. 8, 2003 (KR) 30-2003-0025623

(51) **LOC (8) Cl.** **21-02**

(52) **U.S. Cl.** **D21/752**

(58) **Field of Search** D21/733, 752;
473/324-331, 345, 346

(56) **References Cited**

U.S. PATENT DOCUMENTS

D453,203 S *	1/2002	Madore et al.	D21/752
6,390,933 B1 *	5/2002	Galloway et al.	473/345
D461,862 S *	8/2002	Madore et al.	D21/752
D462,101 S *	8/2002	Debenon	D21/752
6,435,982 B1 *	8/2002	Galloway et al.	473/342
D481,091 S *	10/2003	Antonious	D21/752
6,669,576 B1 *	12/2003	Rice	473/305

* cited by examiner

Primary Examiner—Mitchell Siegel

(74) *Attorney, Agent, or Firm*—Sughrue Mion, PLLC

(57) **CLAIM**

The ornamental design for a wood golf head, as shown and described.

DESCRIPTION

FIG. 1 is a front elevational view of a wood golf club head

showing my new design according to a first embodiment of the invention;

FIG. 2 is a rear elevational view of the wood golf club head of FIG. 1;

FIG. 3 is a right-hand side elevational view of the wood golf club head of FIG. 1;

FIG. 4 is a left-hand side elevational view of the wood golf club head of FIG. 1;

FIG. 5 is a top elevational view of the wood golf club head of FIG. 1;

FIG. 6 is a bottom elevational view of the wood golf club head of FIG. 1;

FIG. 7 is a perspective view from the front, left-hand side of the wood golf club head of FIG. 1;

FIG. 8 is a perspective view from the rear, right-hand side of the wood golf club head of FIG. 1;

FIG. 9 is a front perspective view of the wood golf club head of FIG. 1;

FIG. 10 is a bottom perspective view of the wood golf club head of FIG. 1;

FIG. 11 is a bottom perspective view from the front of the wood golf club head of FIG. 1;

FIG. 12 is a bottom perspective view from the rear, right-hand side of the wood golf club head of FIG. 1; and,

FIG. 13 is a bottom perspective view from the left-hand side of the wood golf club head of FIG. 1.

The color, alphanumerical characters and/or graphical icons appearing on the rear, top and bottom of the golf club head form no part of my invention.

1 Claim, 13 Drawing Sheets

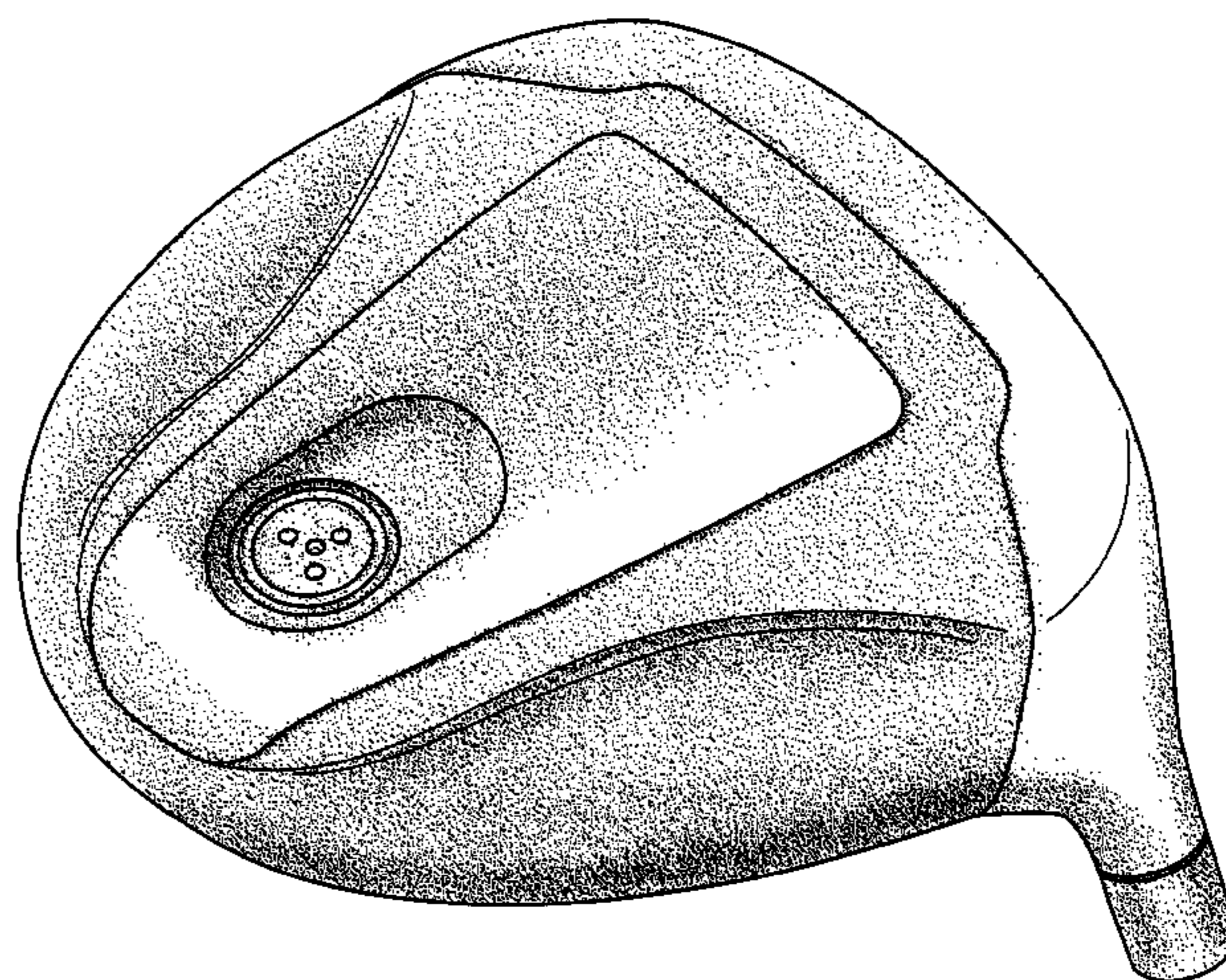
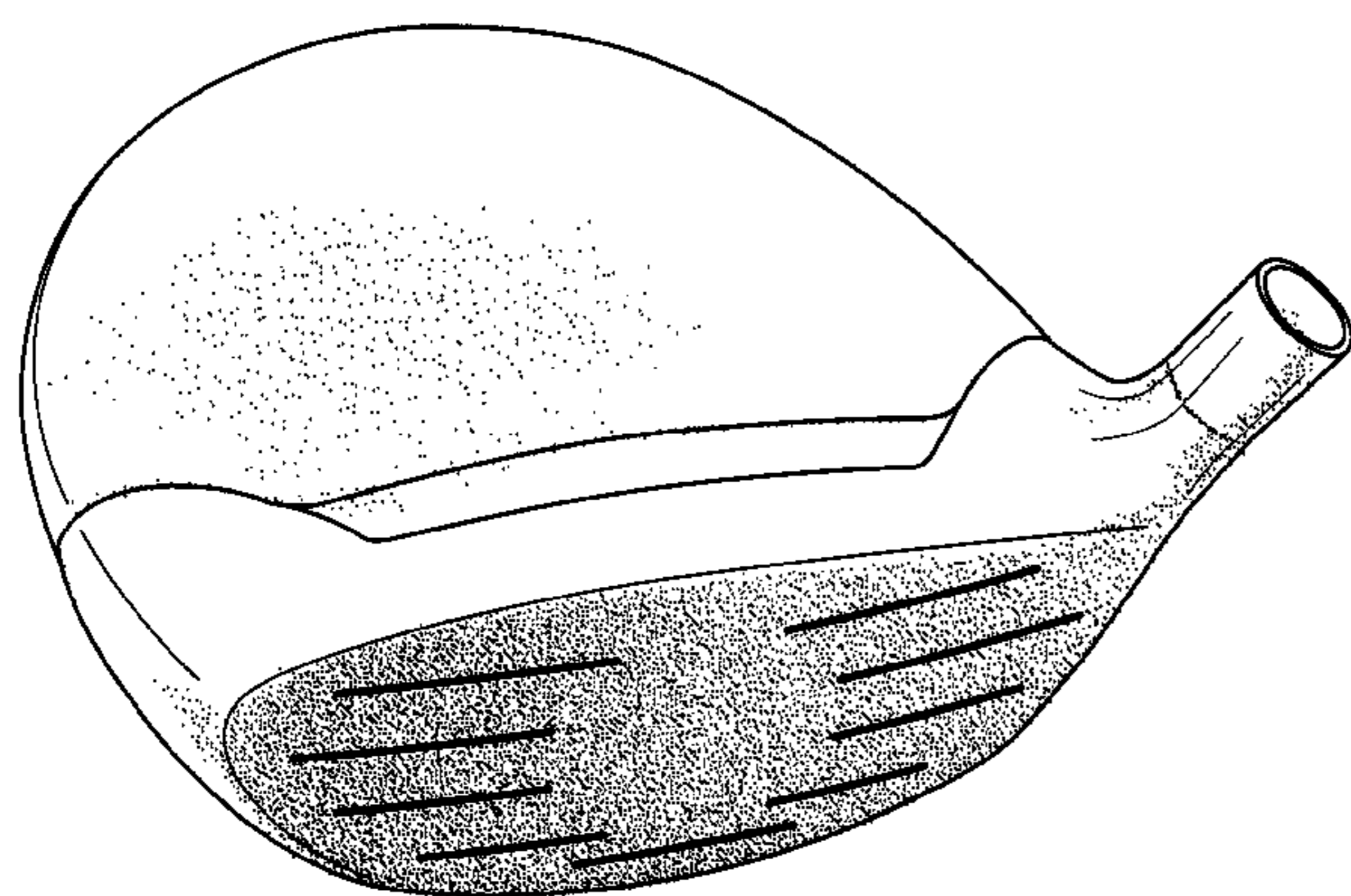

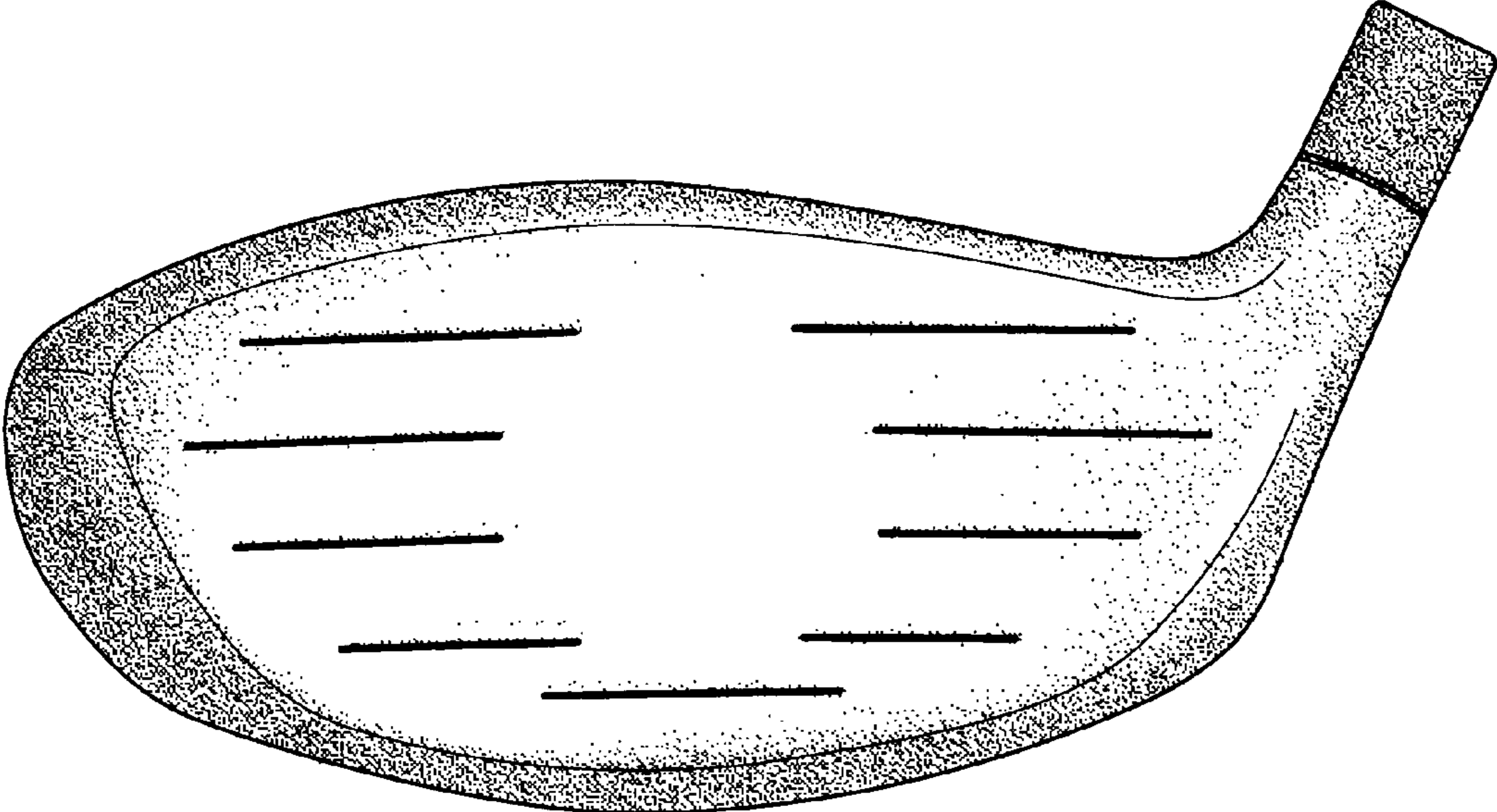

Fig. 1

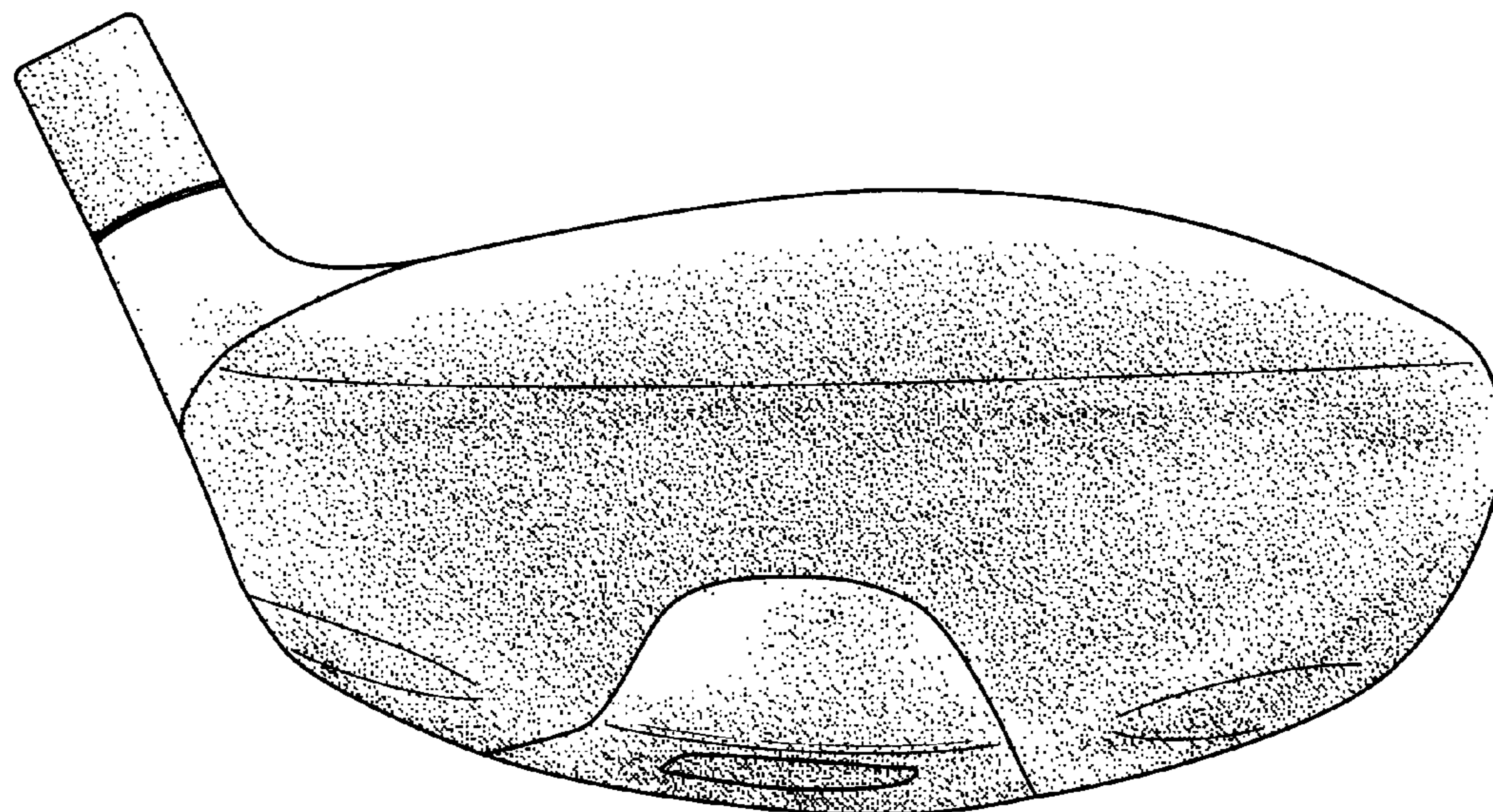

Fig. 2

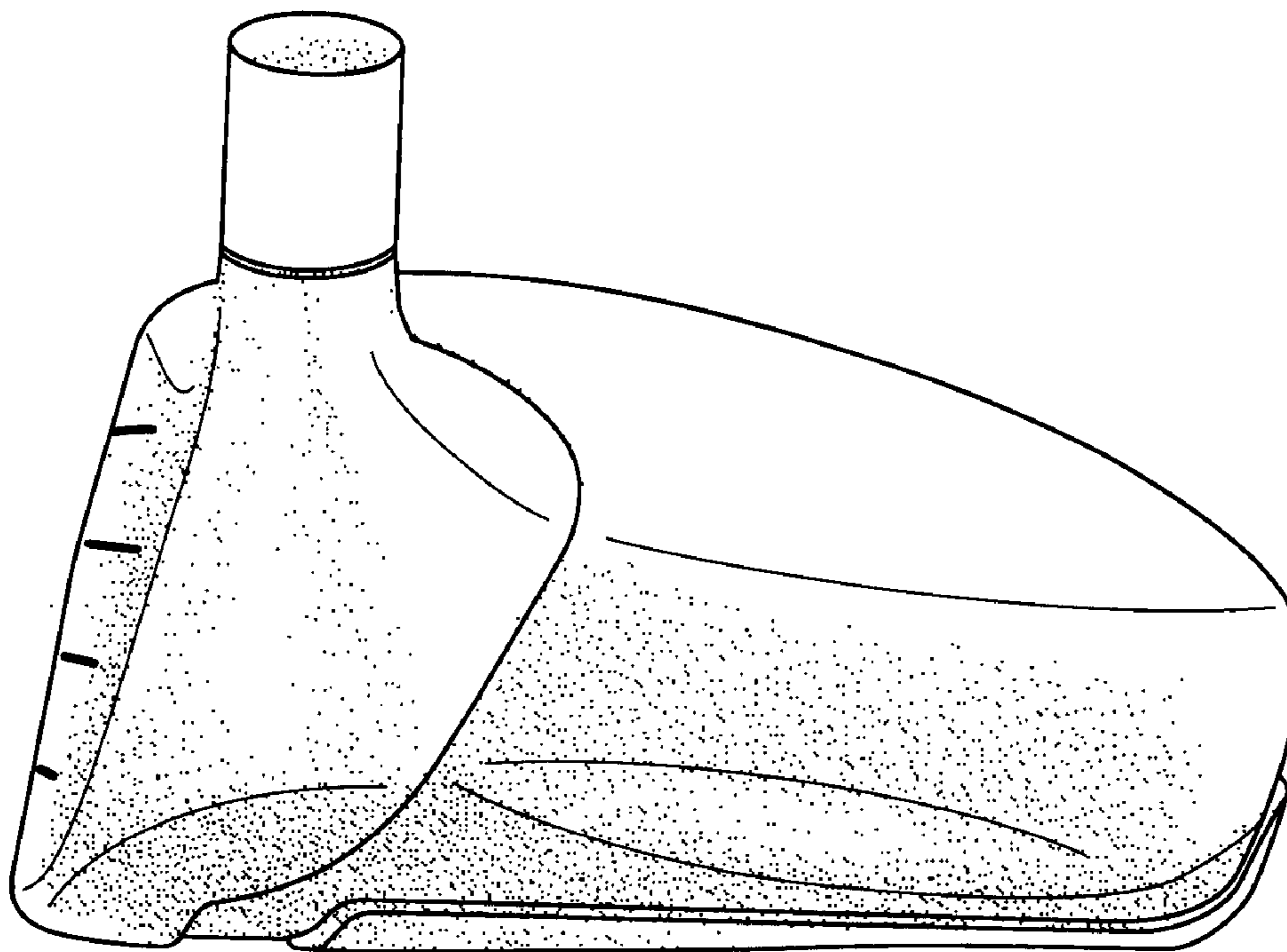

Fig. 3

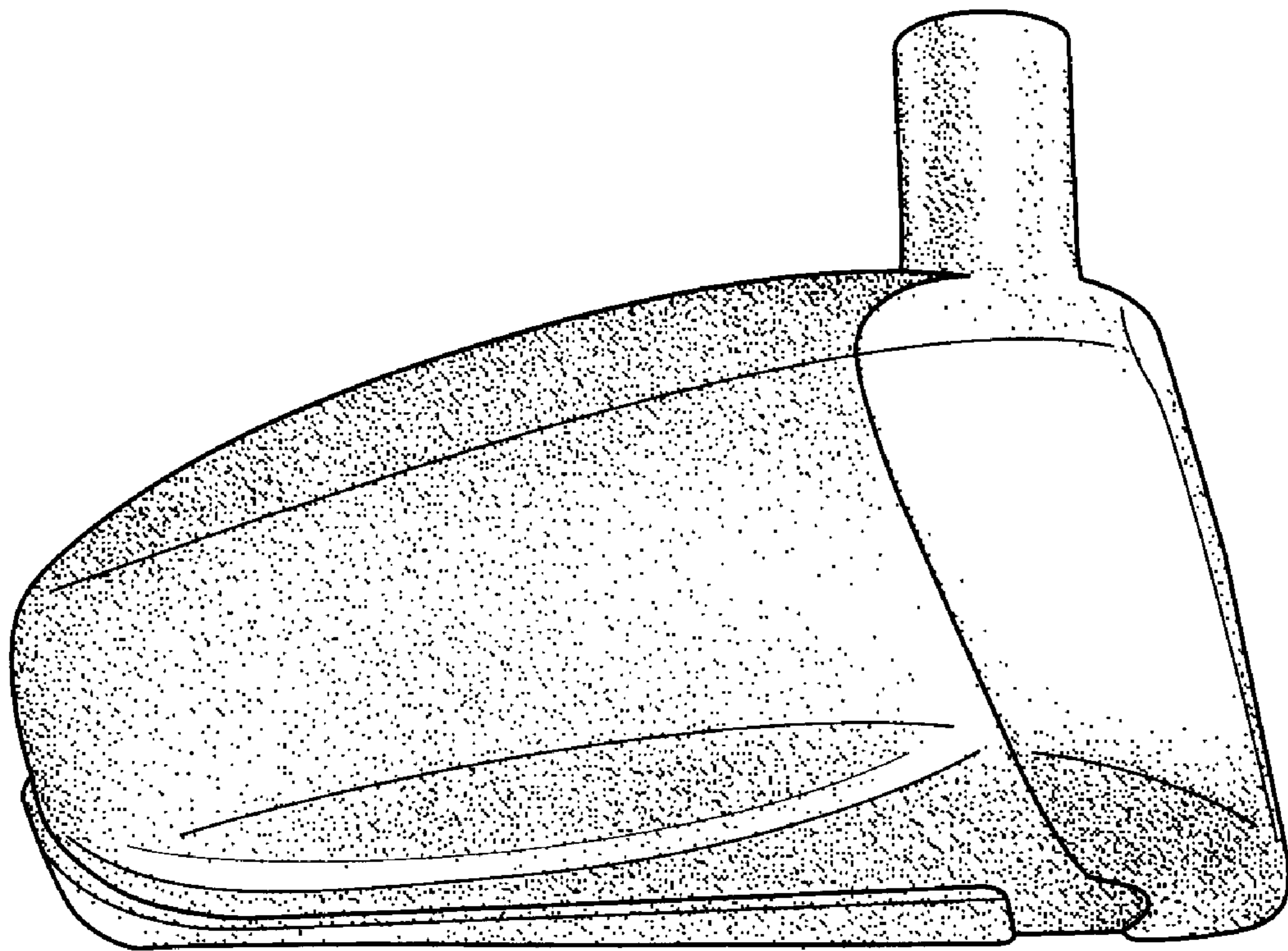

Fig. 4

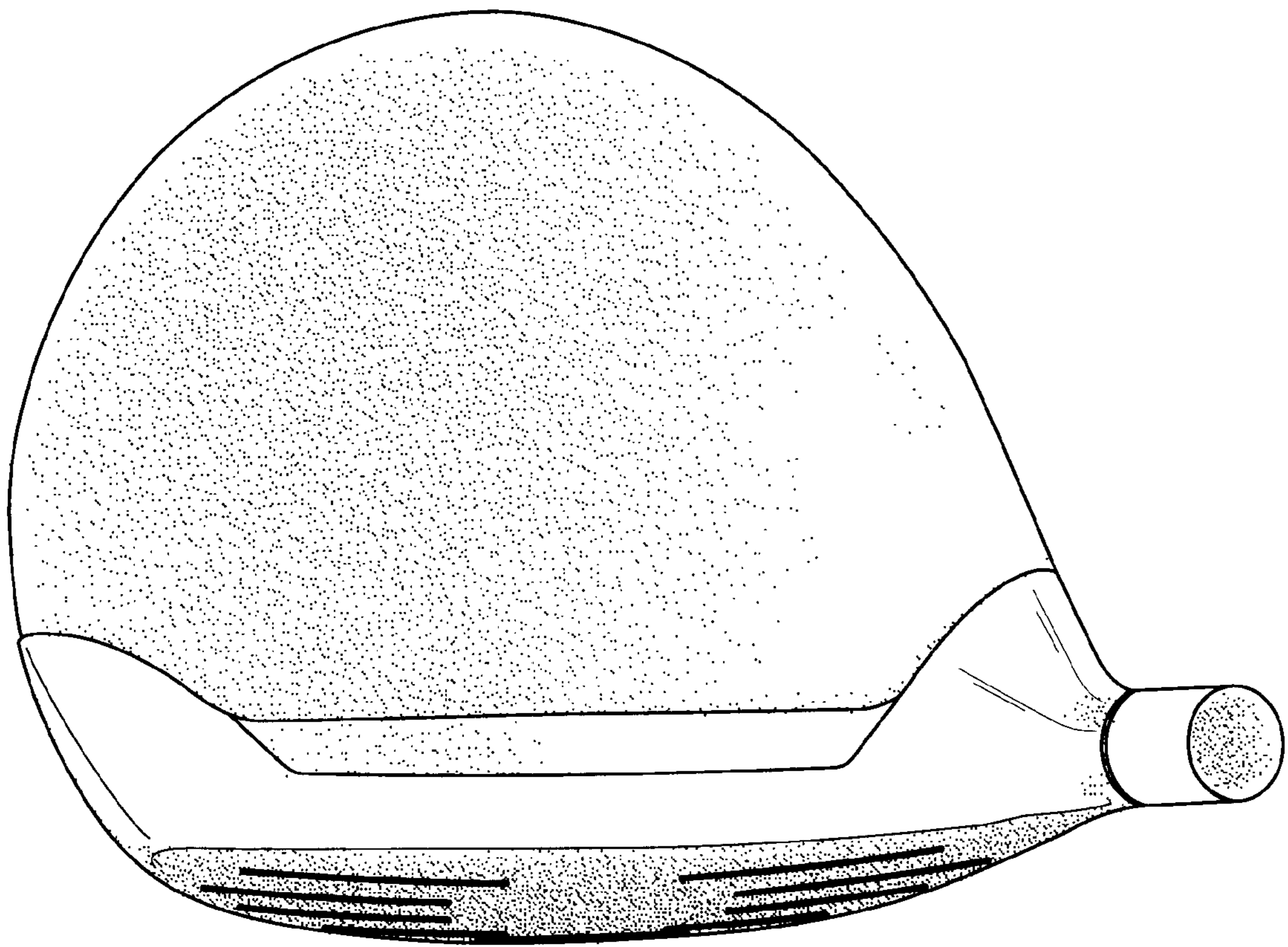

Fig. 5

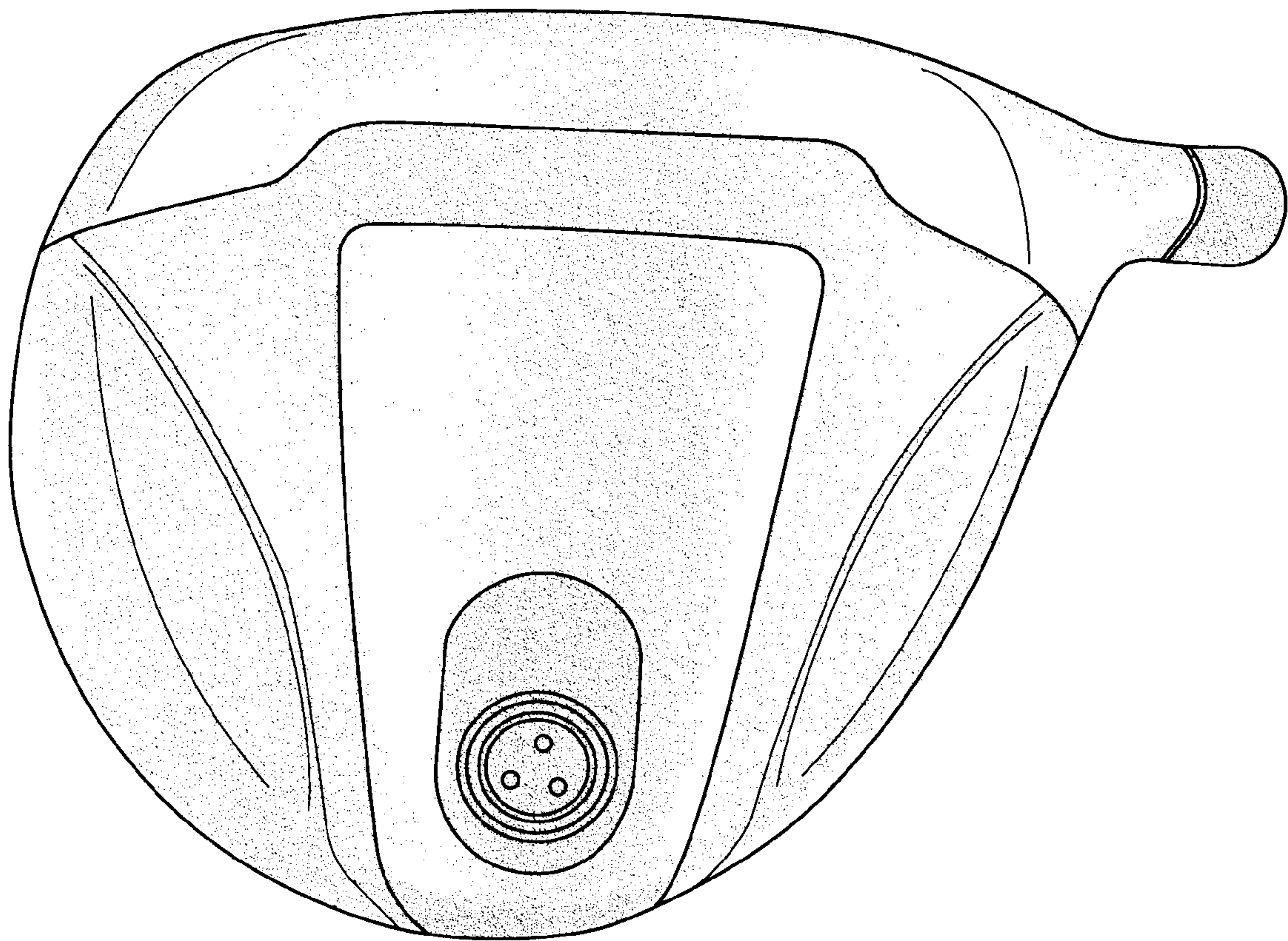

Fig. 6

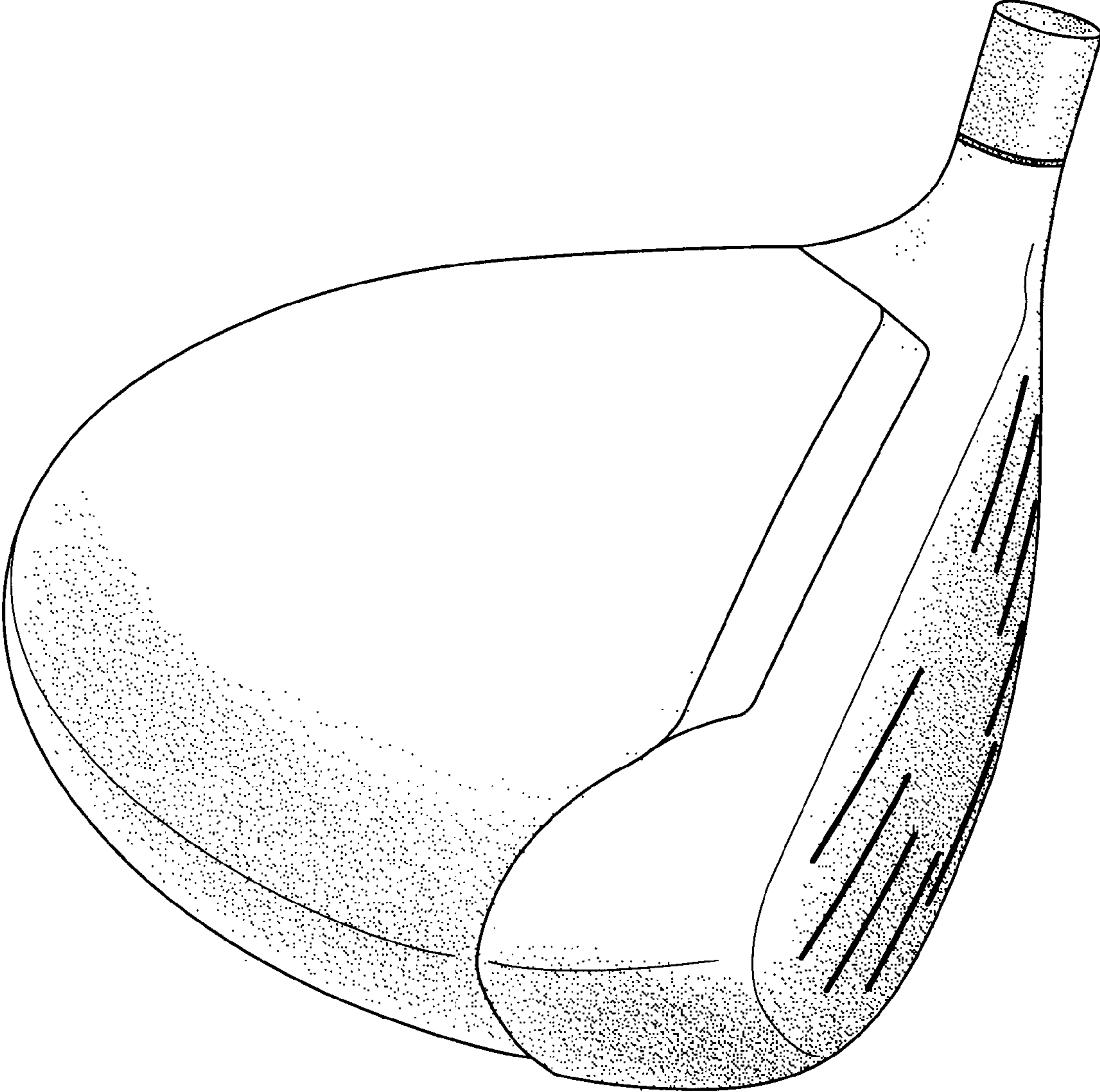

Fig. 7

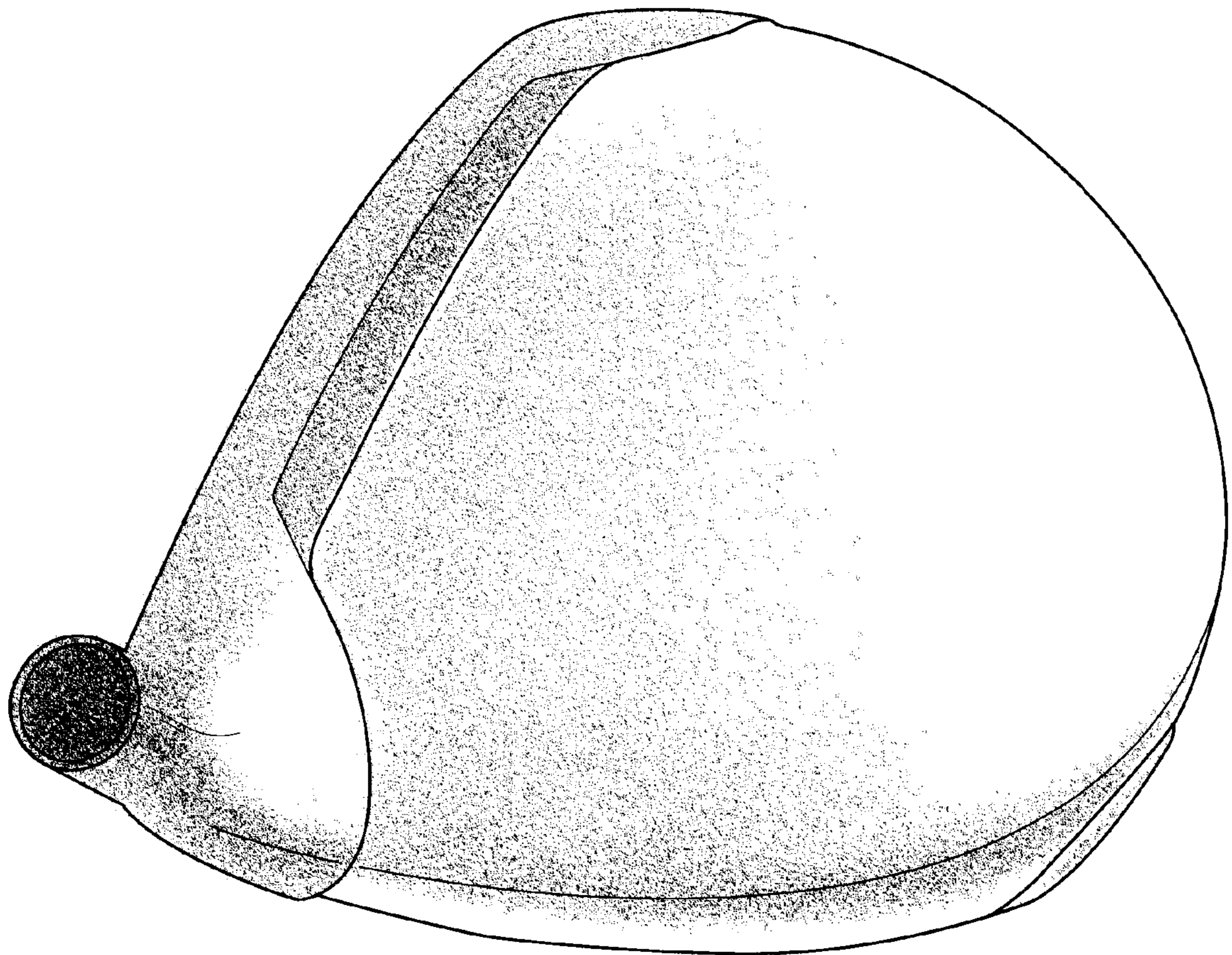

Fig. 8

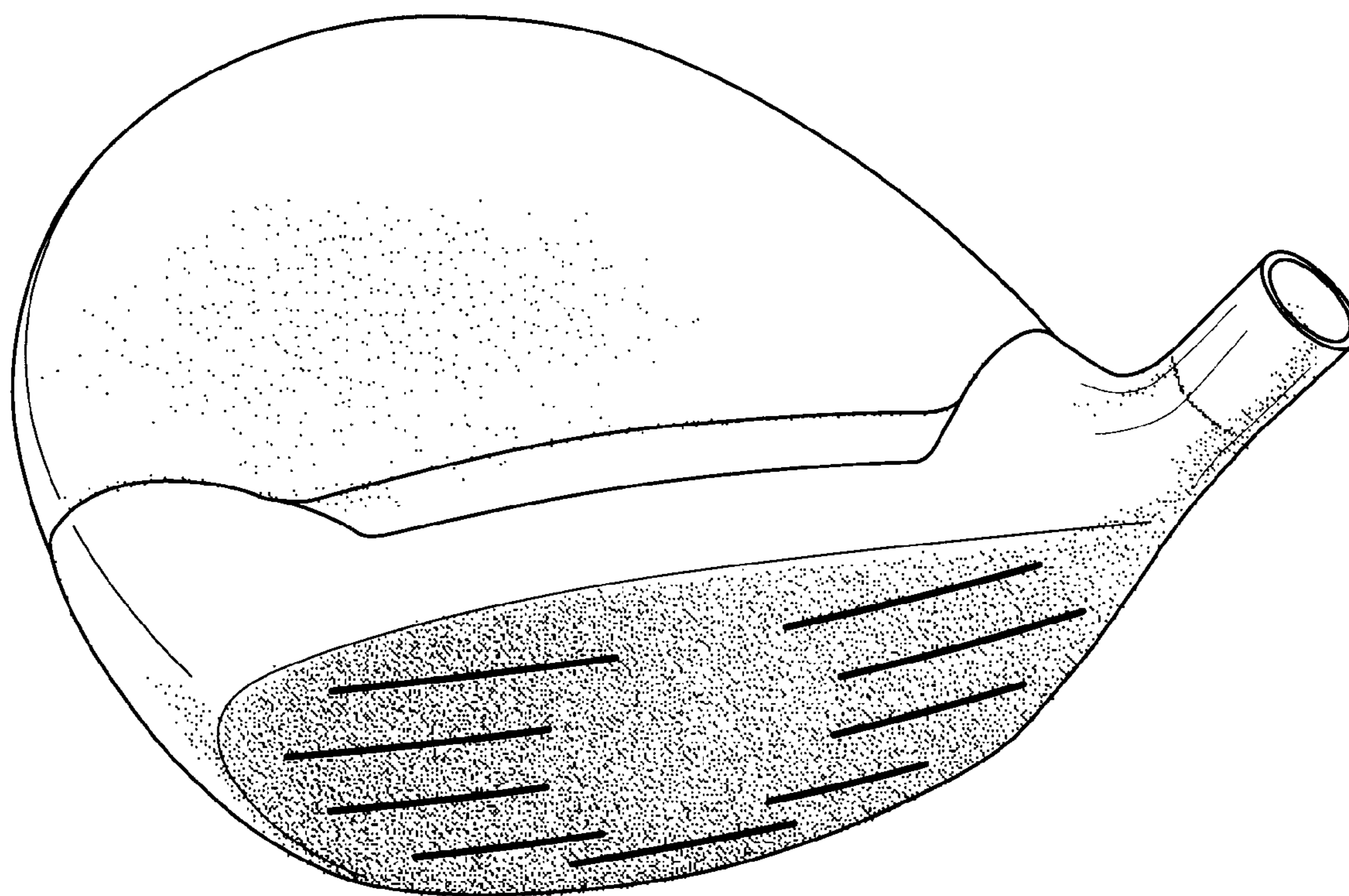

Fig. 9

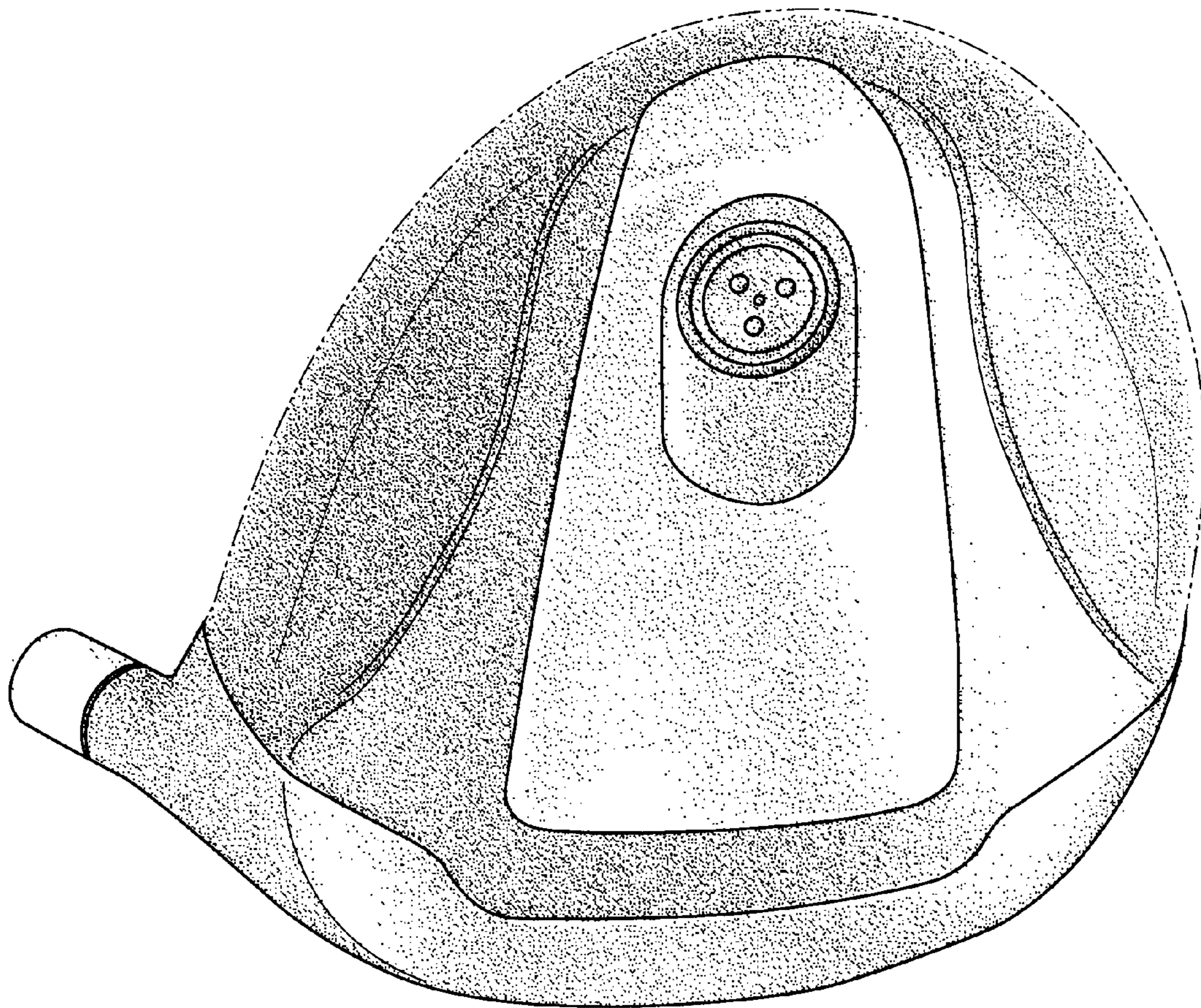

Fig. 10

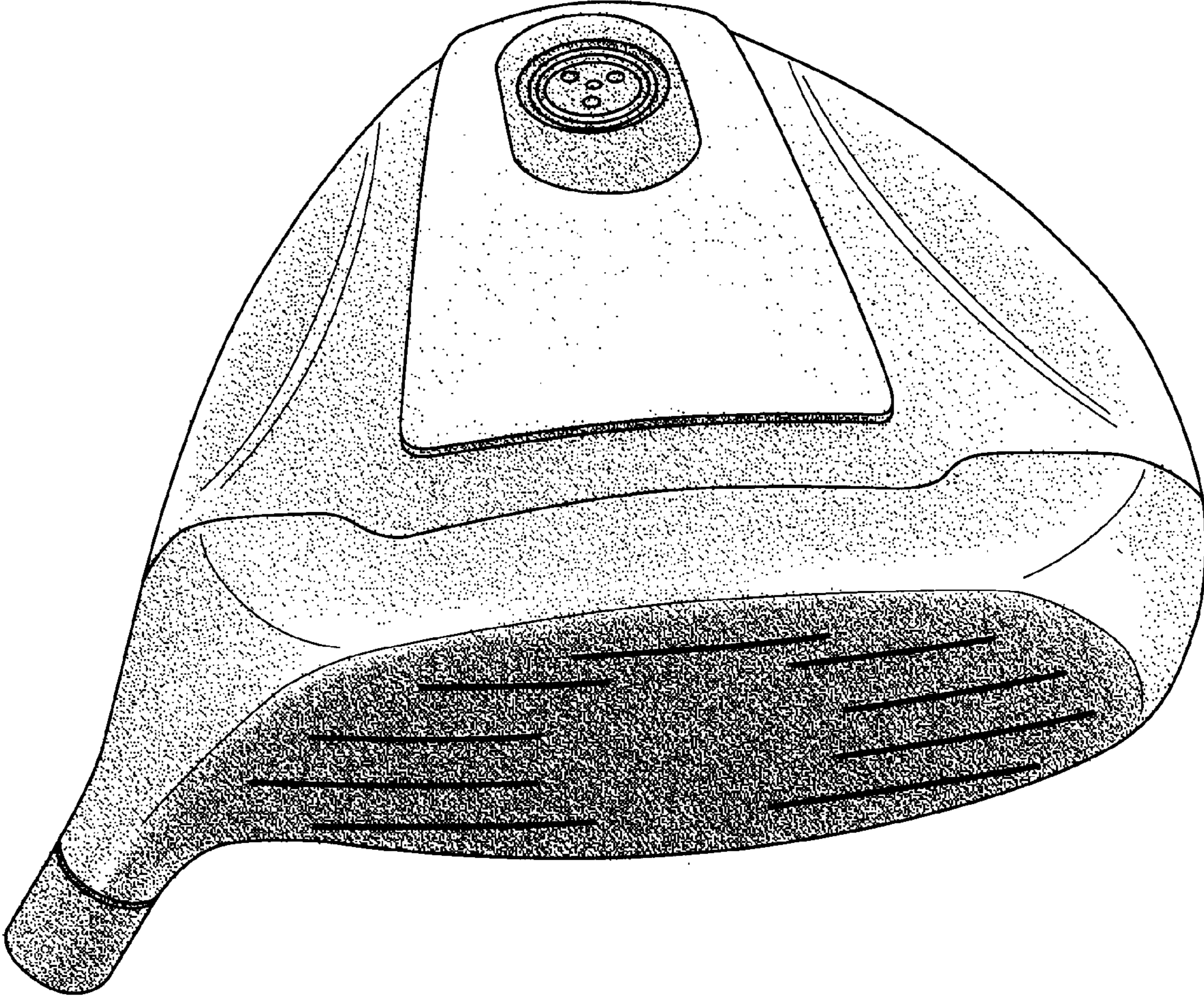

Fig. 11

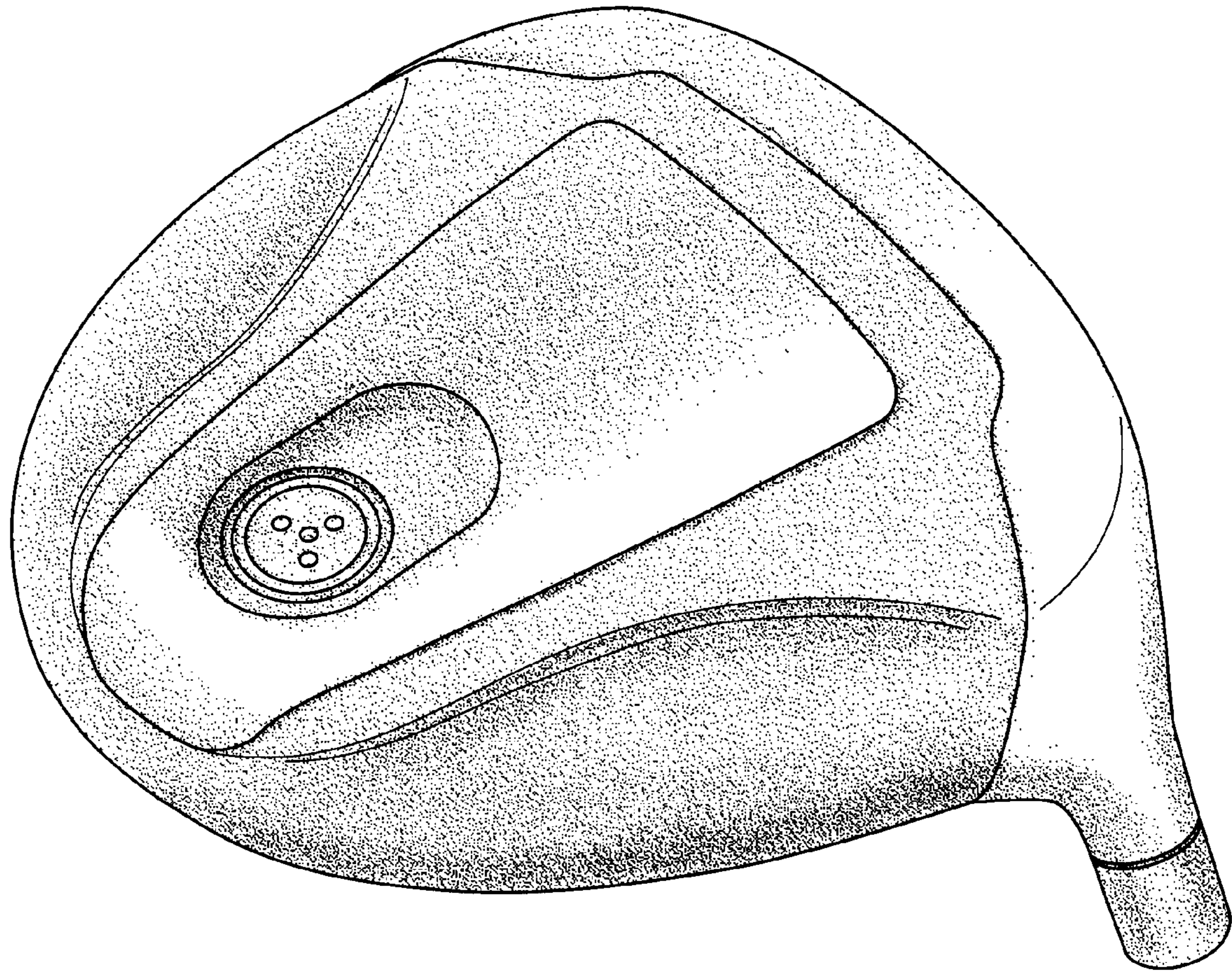

Fig. 12

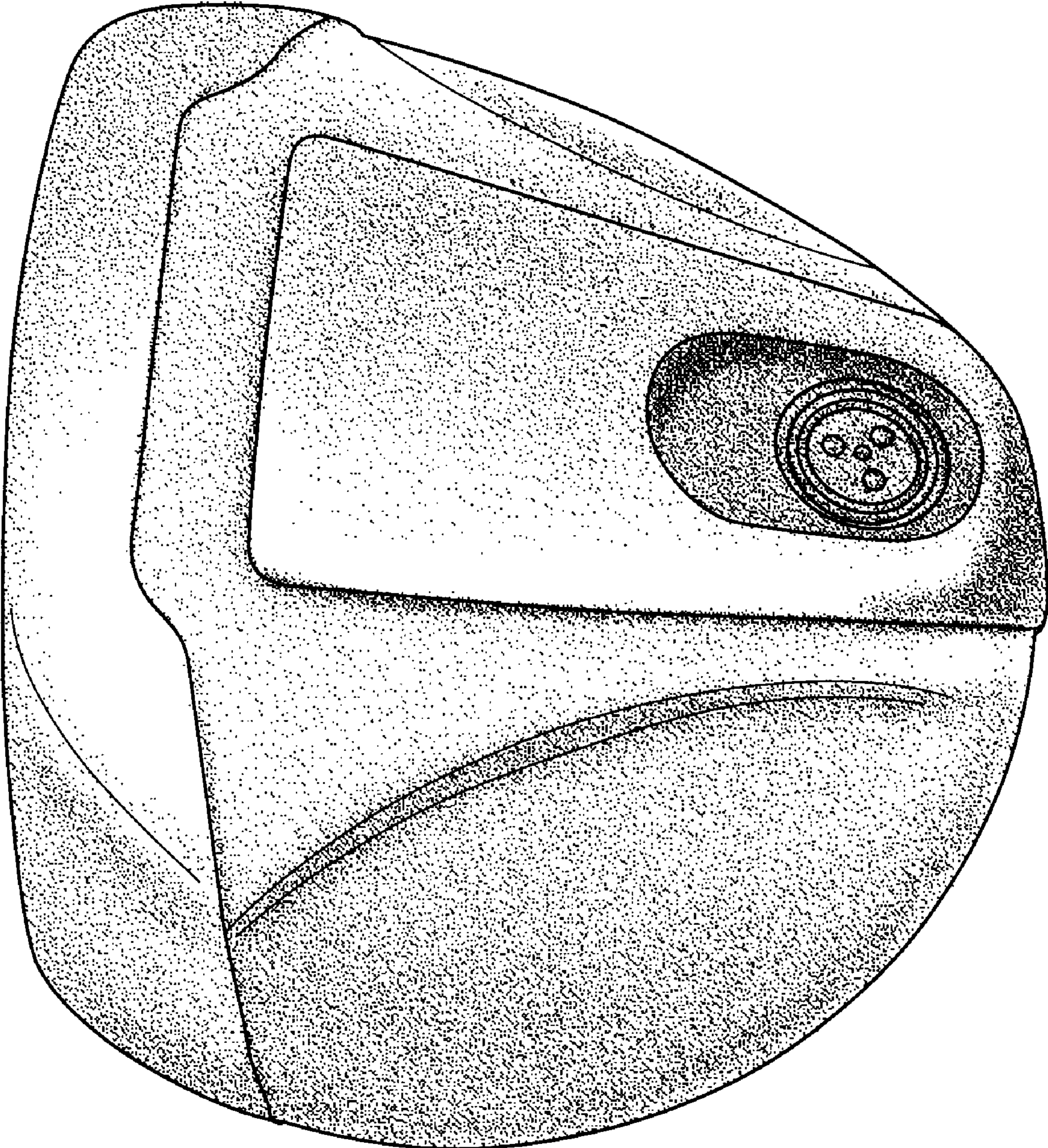

Fig. 13