

US00D507593S

(12) **United States Design Patent**
Kida et al.

(10) **Patent No.:** **US D507,593 S**
(45) **Date of Patent:** **** Jul. 19, 2005**

(54) **STAMP**

(75) Inventors: **Masaki Kida**, Setagaya-ku (JP);
Motohide Imaizumi, Setagaya-ku (JP)

(73) Assignee: **Shachihata Inc.**, Aichi (JP)

(**) Term: **14 Years**

(21) Appl. No.: **29/209,585**

(22) Filed: **Jul. 19, 2004**

(30) **Foreign Application Priority Data**

Jan. 21, 2004 (JP) D2004-001351

(51) **LOC (8) Cl.** **19-02**

(52) **U.S. Cl.** **D18/15**

(58) **Field of Search** D18/15-18, 50;
101/333-334, 327, 405, 406, 328, 352.07;
118/264, 268

(56) **References Cited**

U.S. PATENT DOCUMENTS

D231,028 S	*	3/1974	Funahshi	D18/15
D280,643 S	*	9/1985	Ichikawa	D18/15
D378,597 S	*	3/1997	Harden	D18/15
D399,245 S	*	10/1998	Harden	D18/15
D412,181 S	*	7/1999	Harden	D18/15
D422,017 S	*	3/2000	Harden	D18/15
D446,805 S	*	8/2001	Suto	D18/15
D477,628 S	*	7/2003	Zambelli et al.	D18/15
D478,930 S	*	8/2003	Zambelli et al.	D18/15

FOREIGN PATENT DOCUMENTS

GB	2034926	*	2/1994
GB	2067449	*	11/1997

* cited by examiner

Primary Examiner—Charles A. Rademaker
(74) *Attorney, Agent, or Firm*—Jacobson Holman PLLC

(57) **CLAIM**

The ornamental design for a stamp, as shown and described.

DESCRIPTION

FIG. 1 is a front elevation of a stamp showing our new design;
 FIG. 2 is a rear elevation thereof;
 FIG. 3 is a right side elevation thereof;
 FIG. 4 is a left side elevation thereof;
 FIG. 5 is a top plan elevation thereof;
 FIG. 6 is a bottom plan view thereof;
 FIG. 7 is a cross-sectional view taken along line A—A in FIG. 1;
 FIG. 8 is a cross-sectional view taken along line B—B in FIG. 3;
 FIG. 9 is a front elevation of the stamp body with the cap omitted for ease of illustration;
 FIG. 10 is a rear elevation thereof;
 FIG. 11 is a right side elevation thereof;
 FIG. 12 is a left side elevation thereof;
 FIG. 13 is a top plan view thereof;
 FIG. 14 is a bottom plan view thereof;
 FIG. 15 is a front elevation of the cap member with the stamp body omitted for ease of illustration;
 FIG. 16 is a rear elevation thereof;
 FIG. 17 is a right side elevation thereof;
 FIG. 18 is a left side elevation thereof;
 FIG. 19 is a top plan view thereof; and,
 FIG. 20 is a bottom plan view thereof.

1 Claim, 5 Drawing Sheets

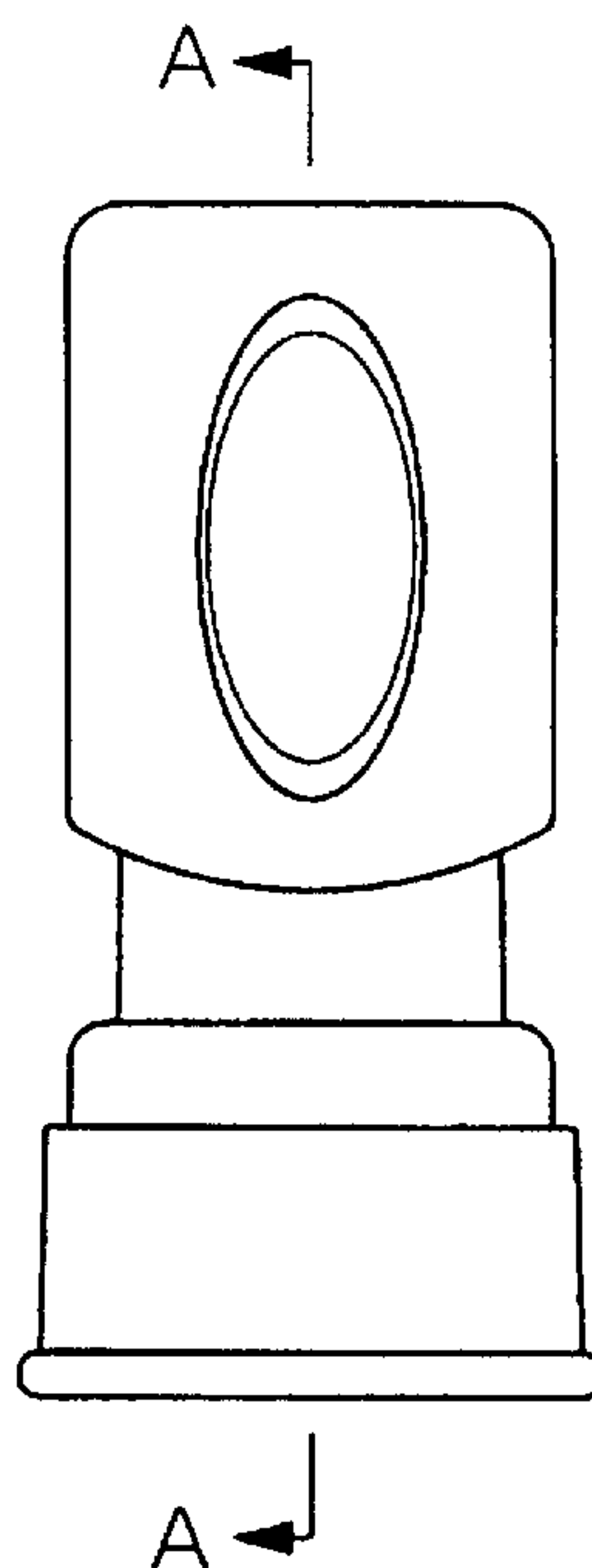

FIG.1

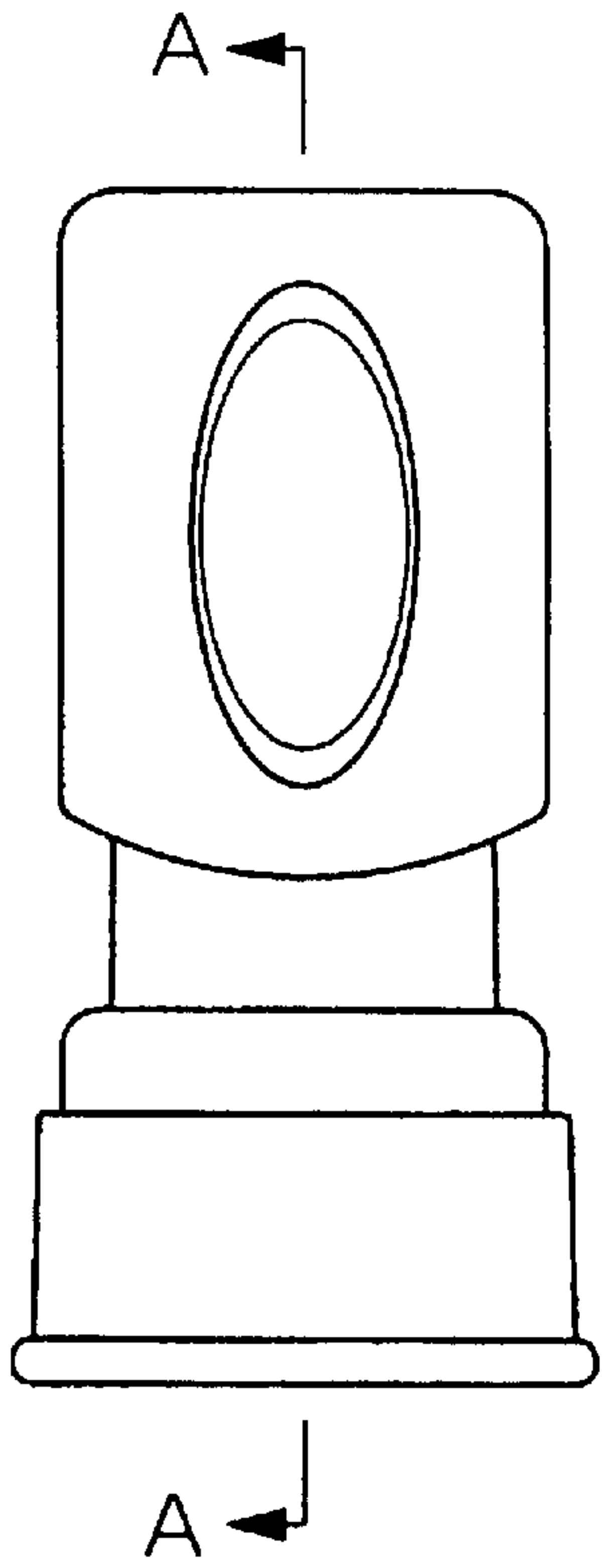

FIG.3

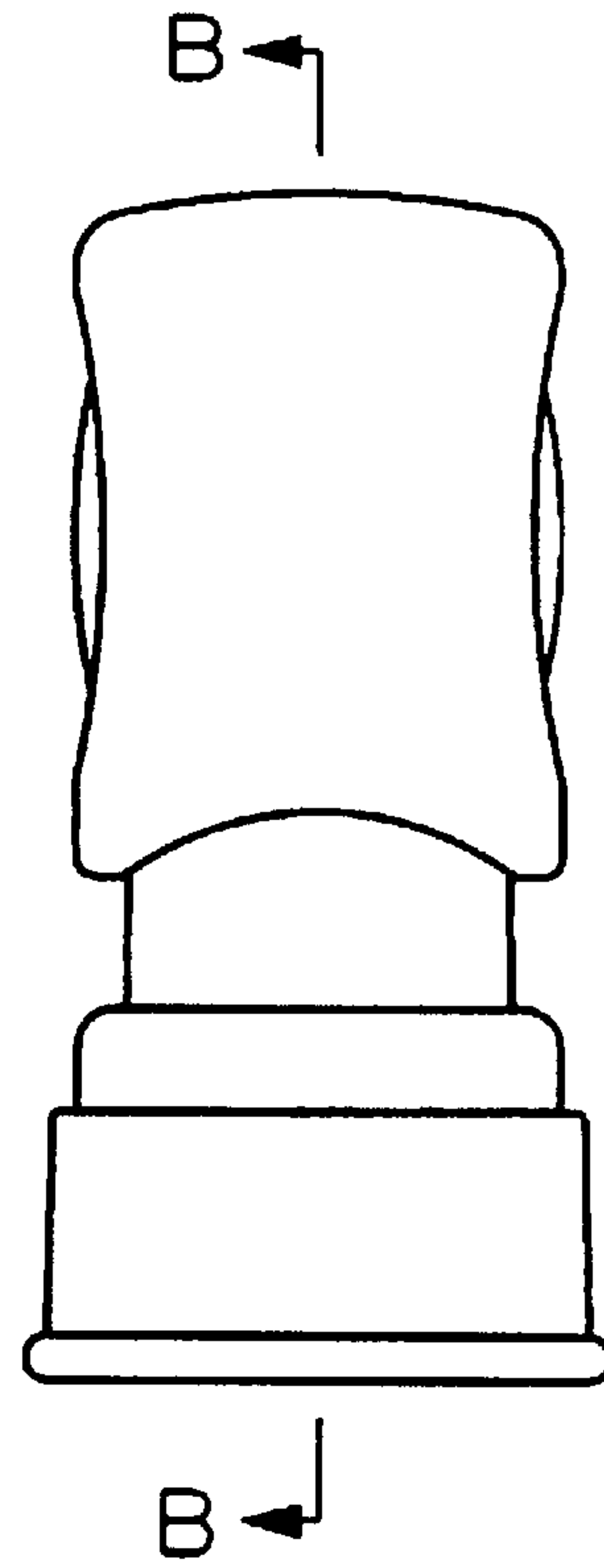

FIG.2

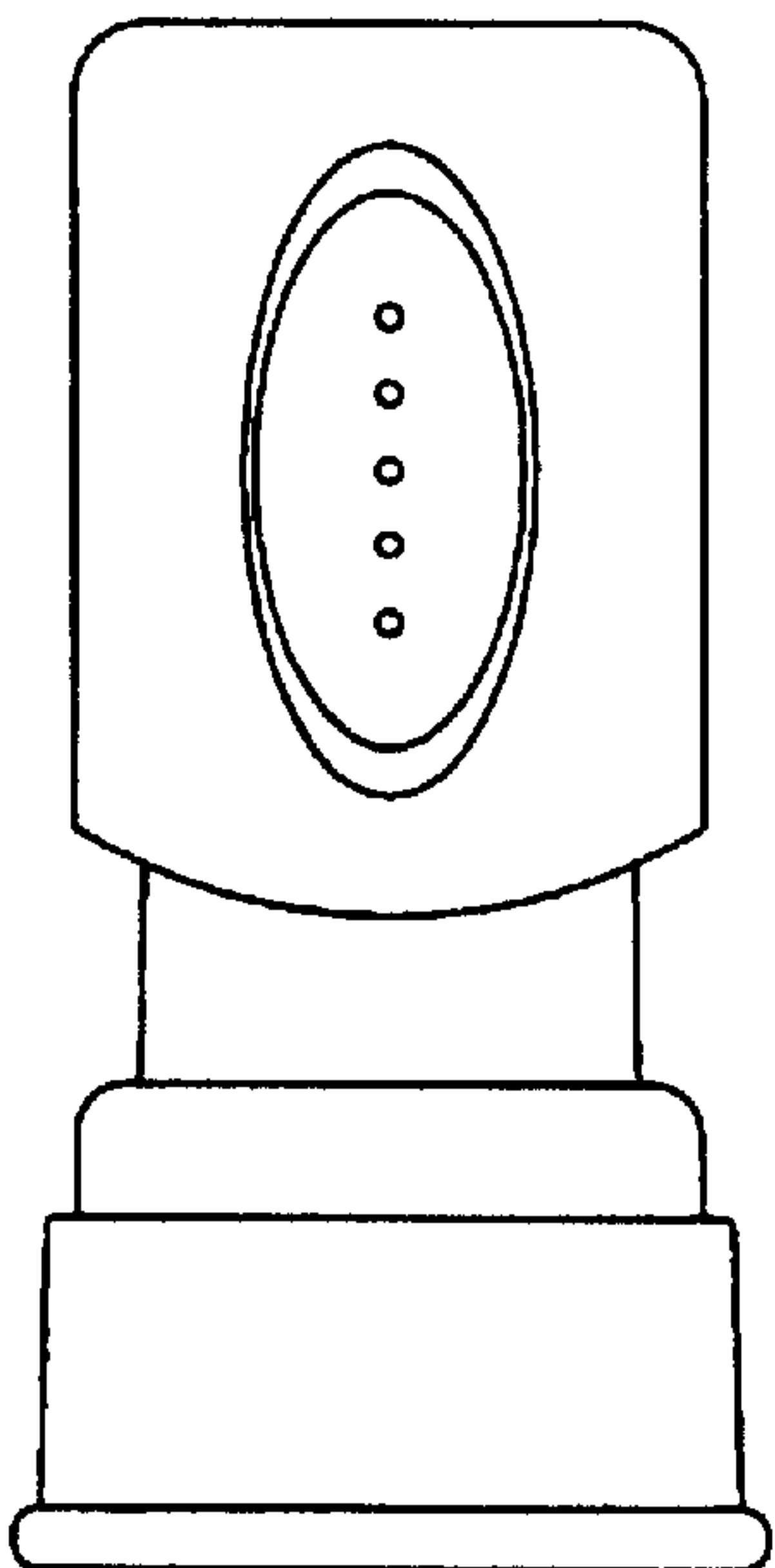

FIG.4

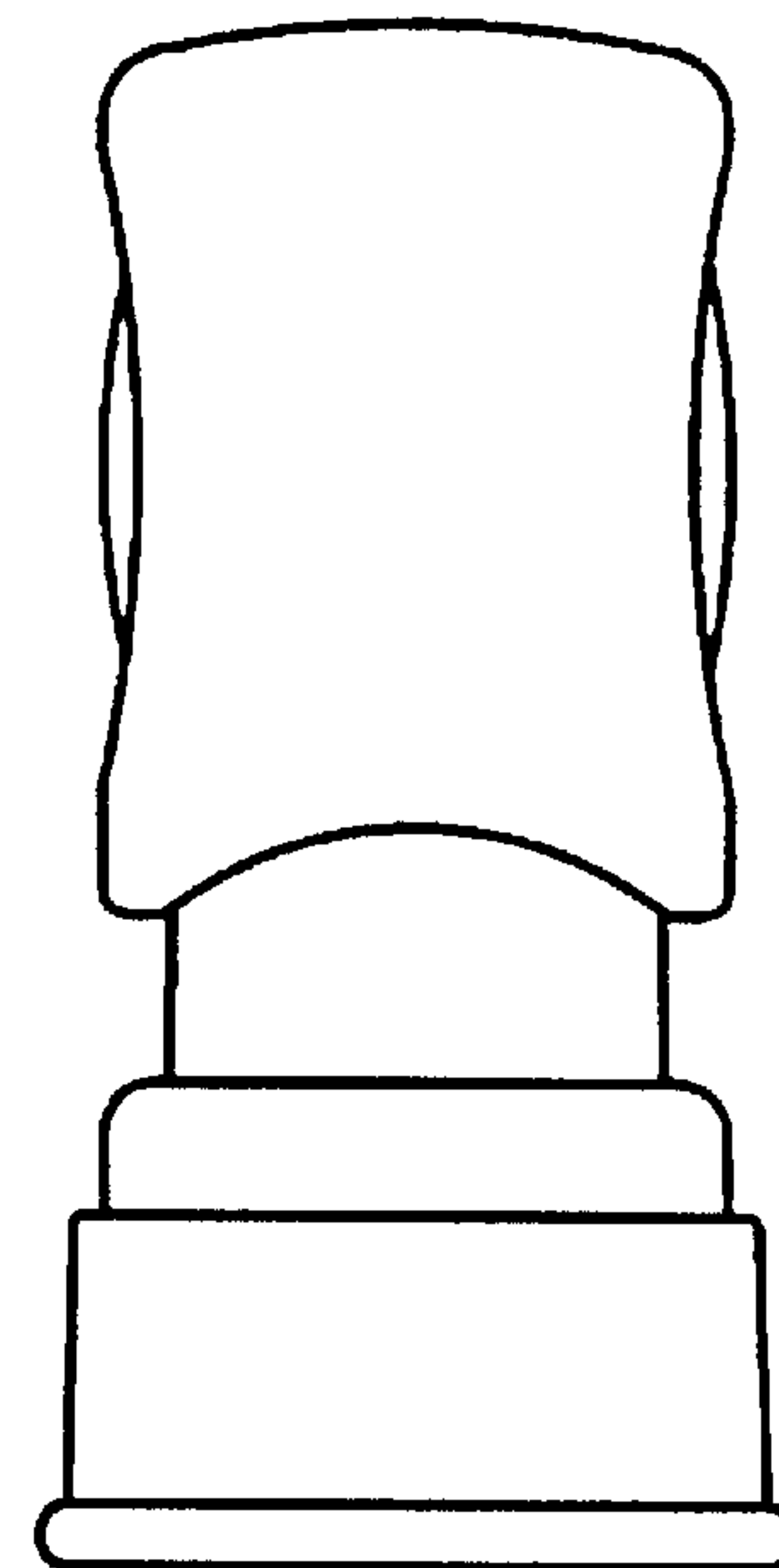

FIG.5

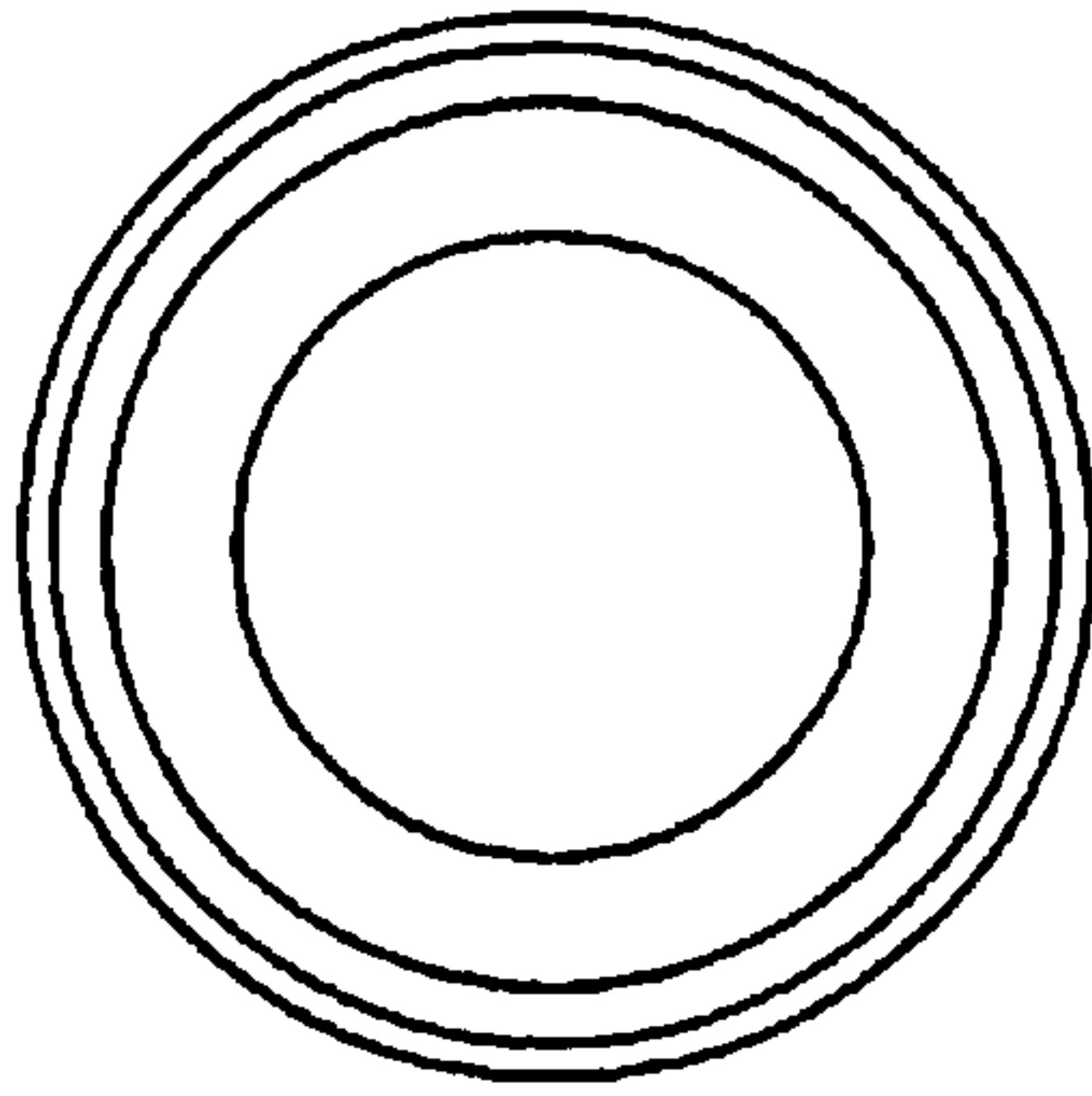

FIG.6

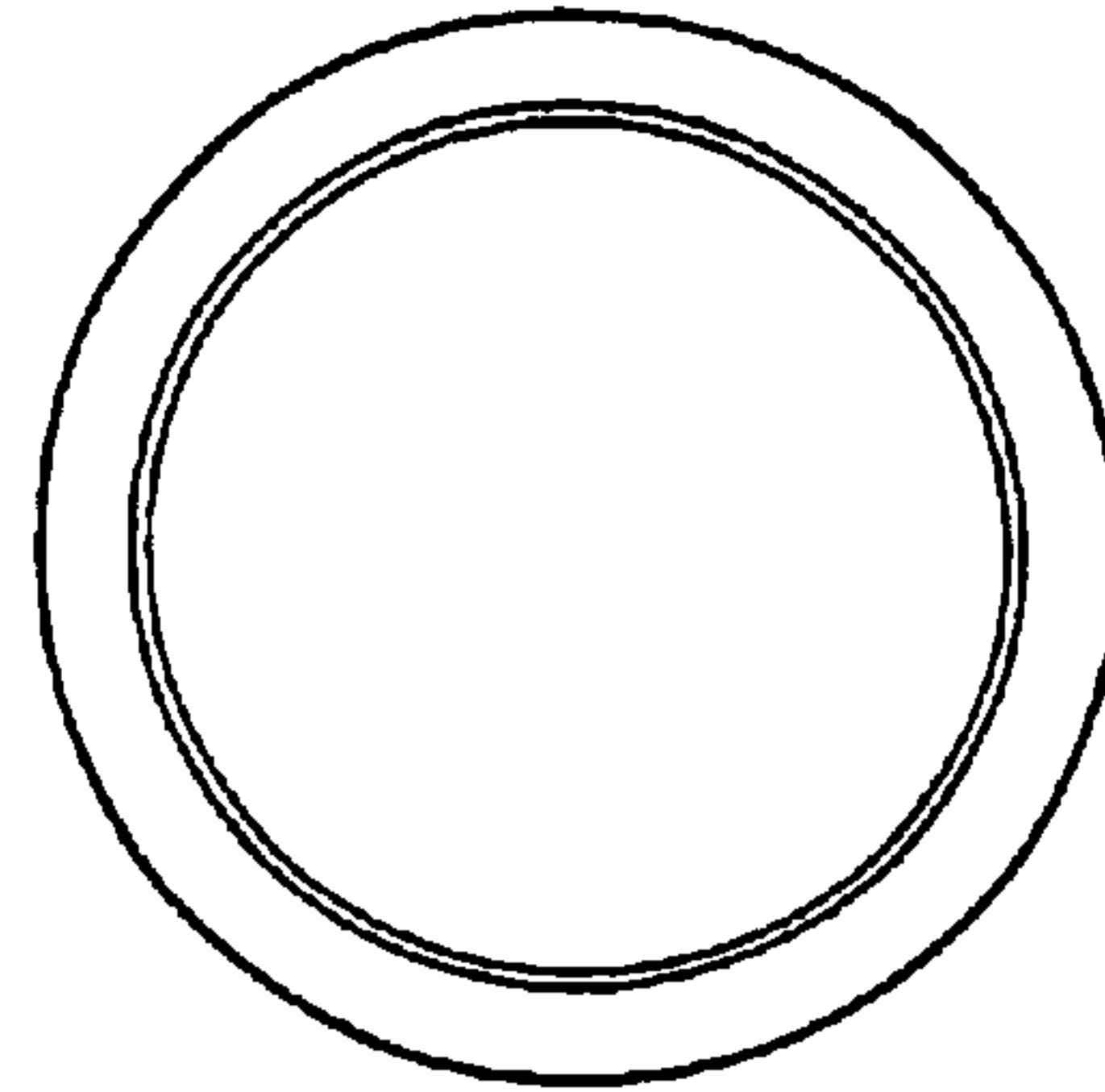

FIG.7

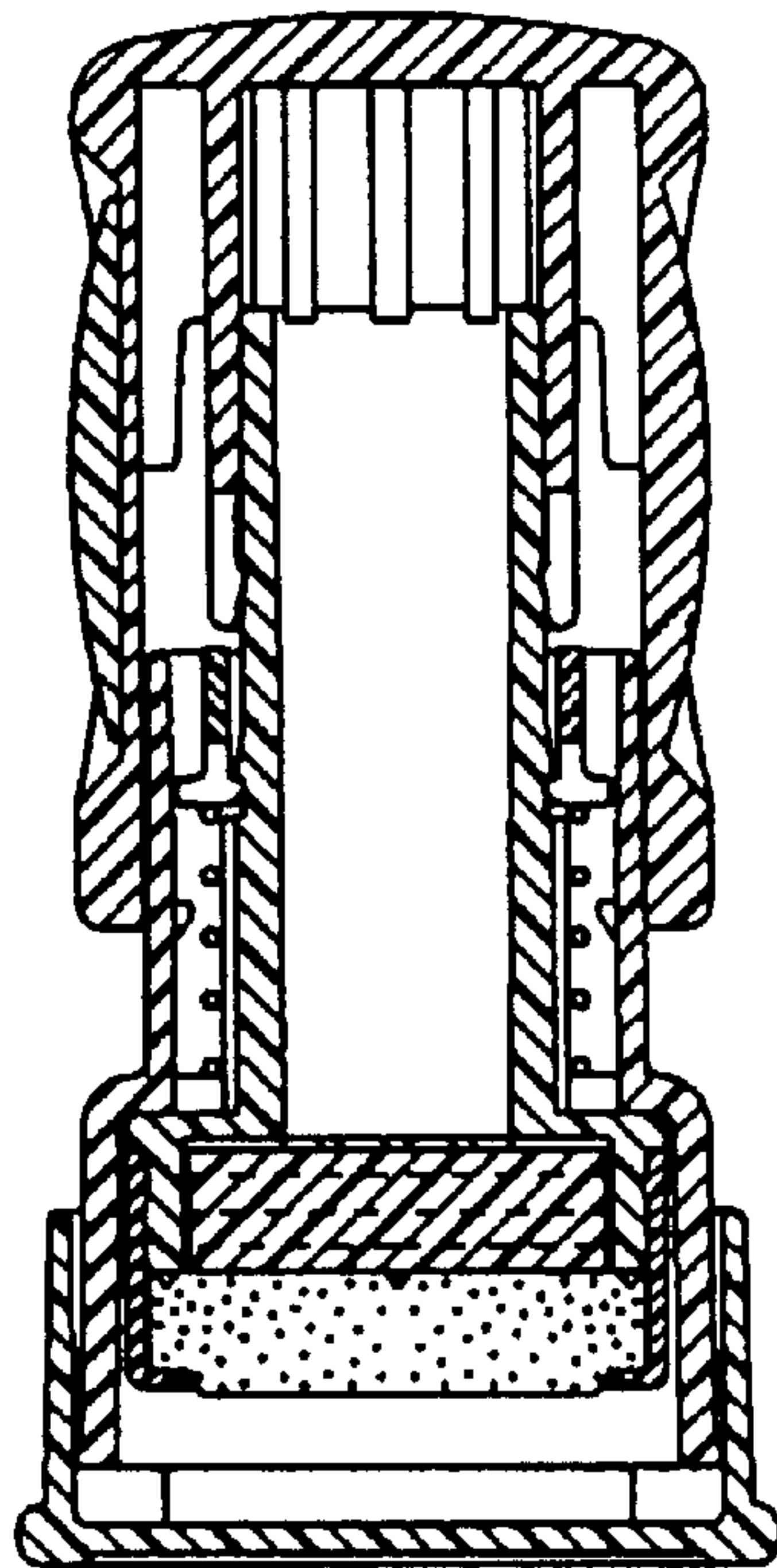

FIG.8

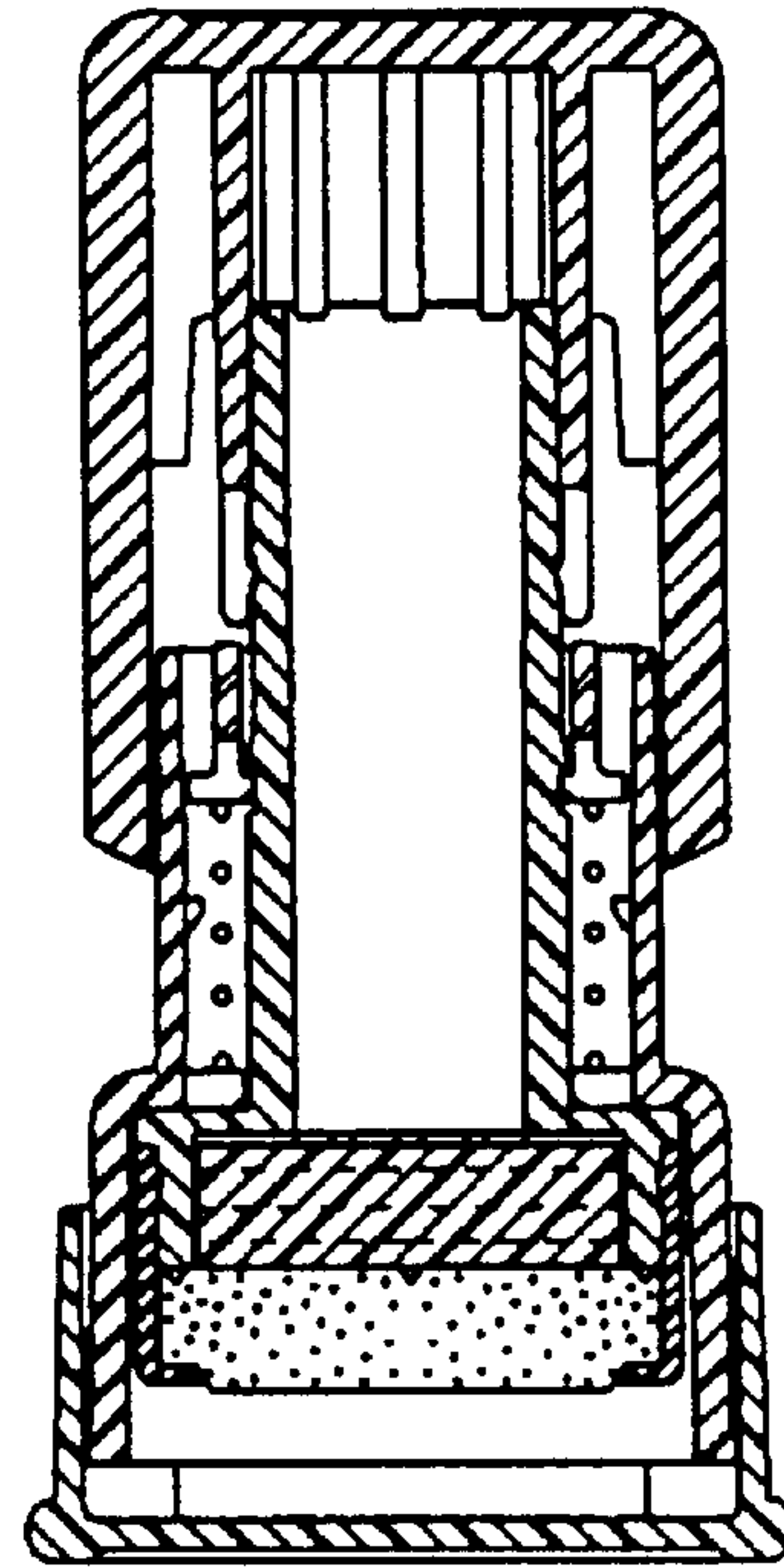

FIG.9

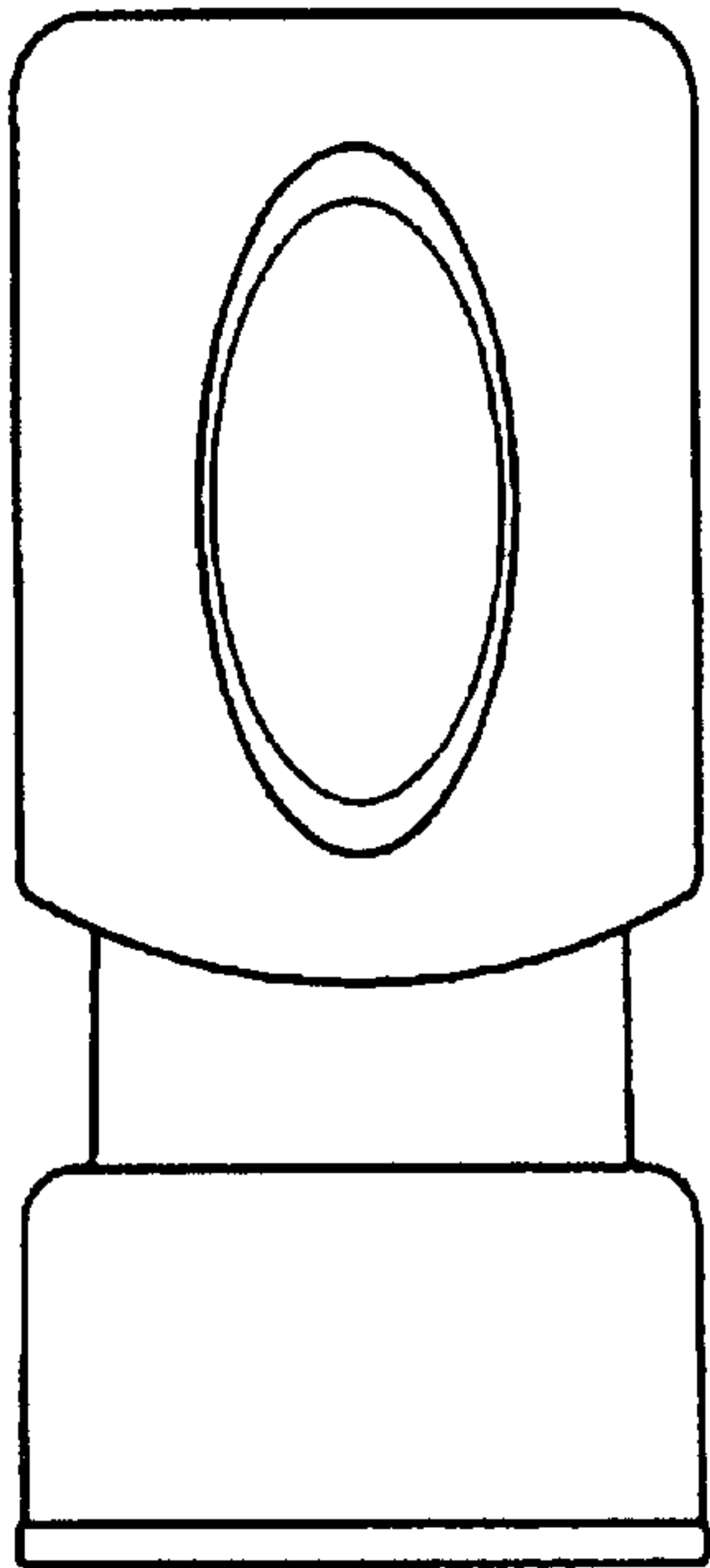

FIG.11

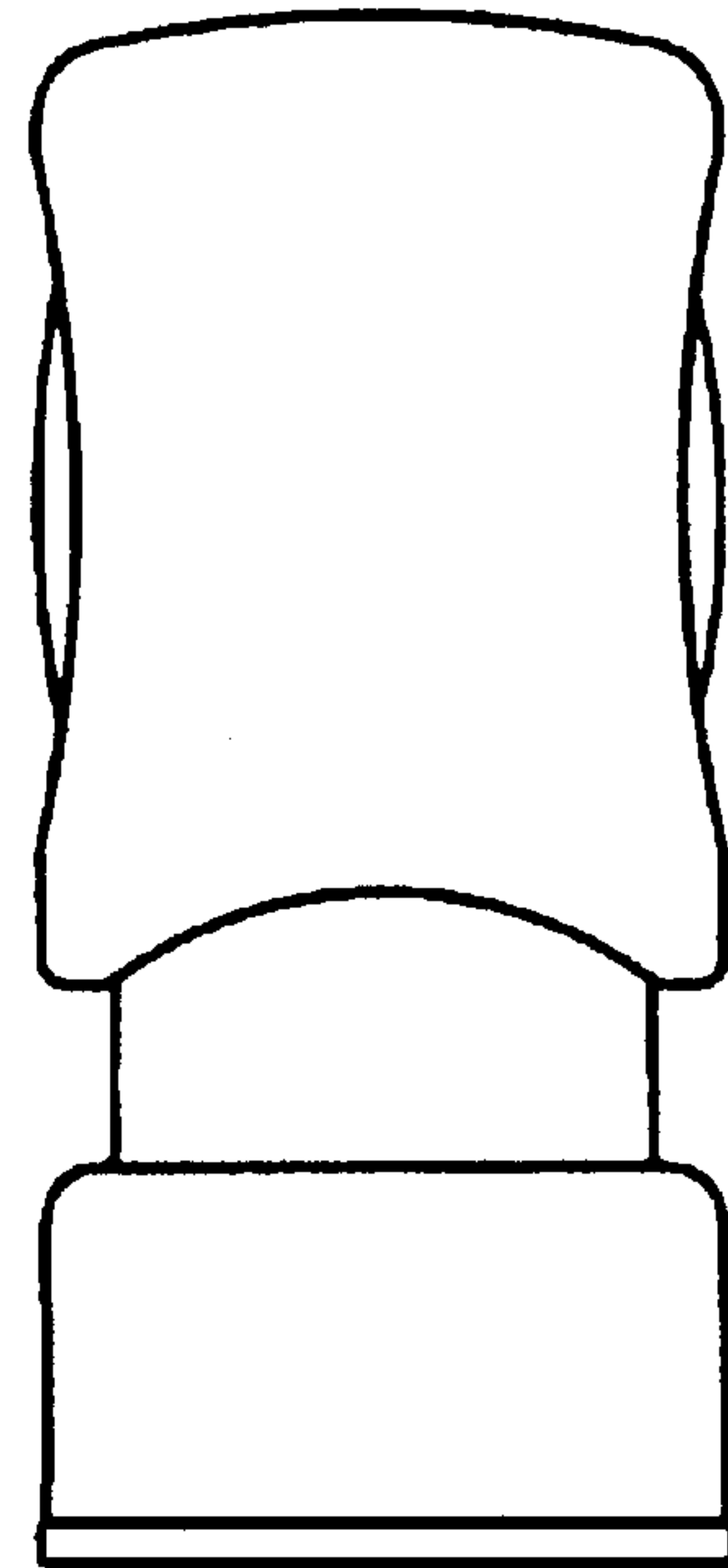

FIG.10

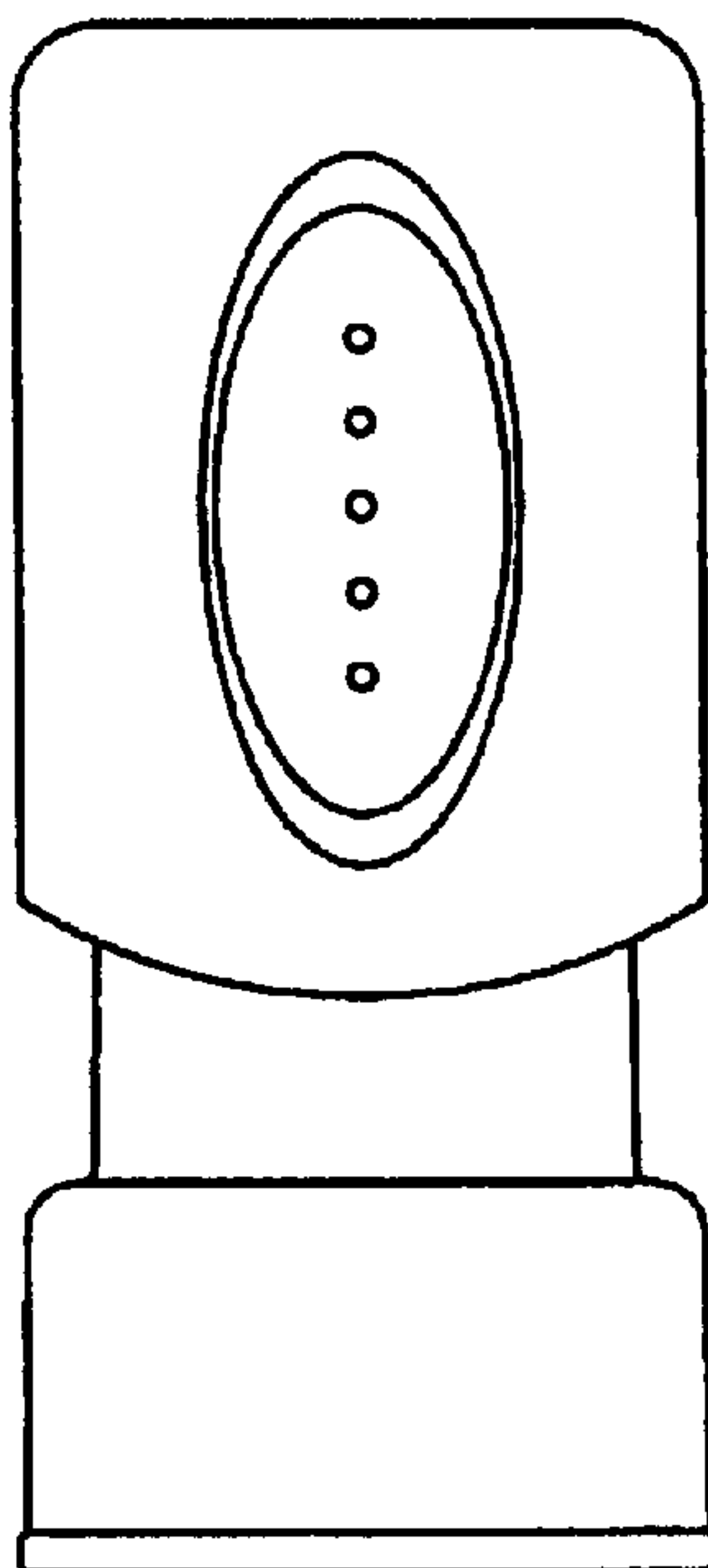

FIG.12

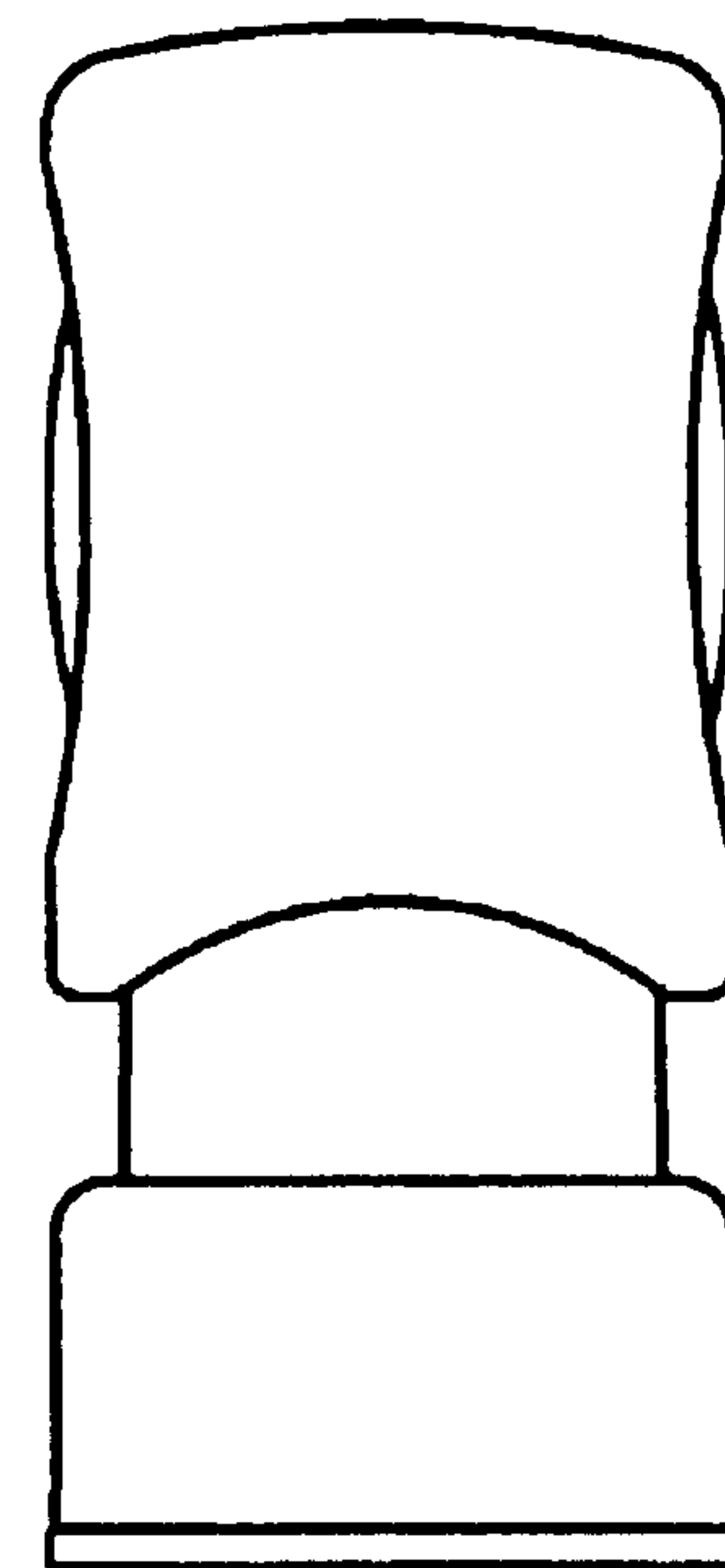

FIG.13

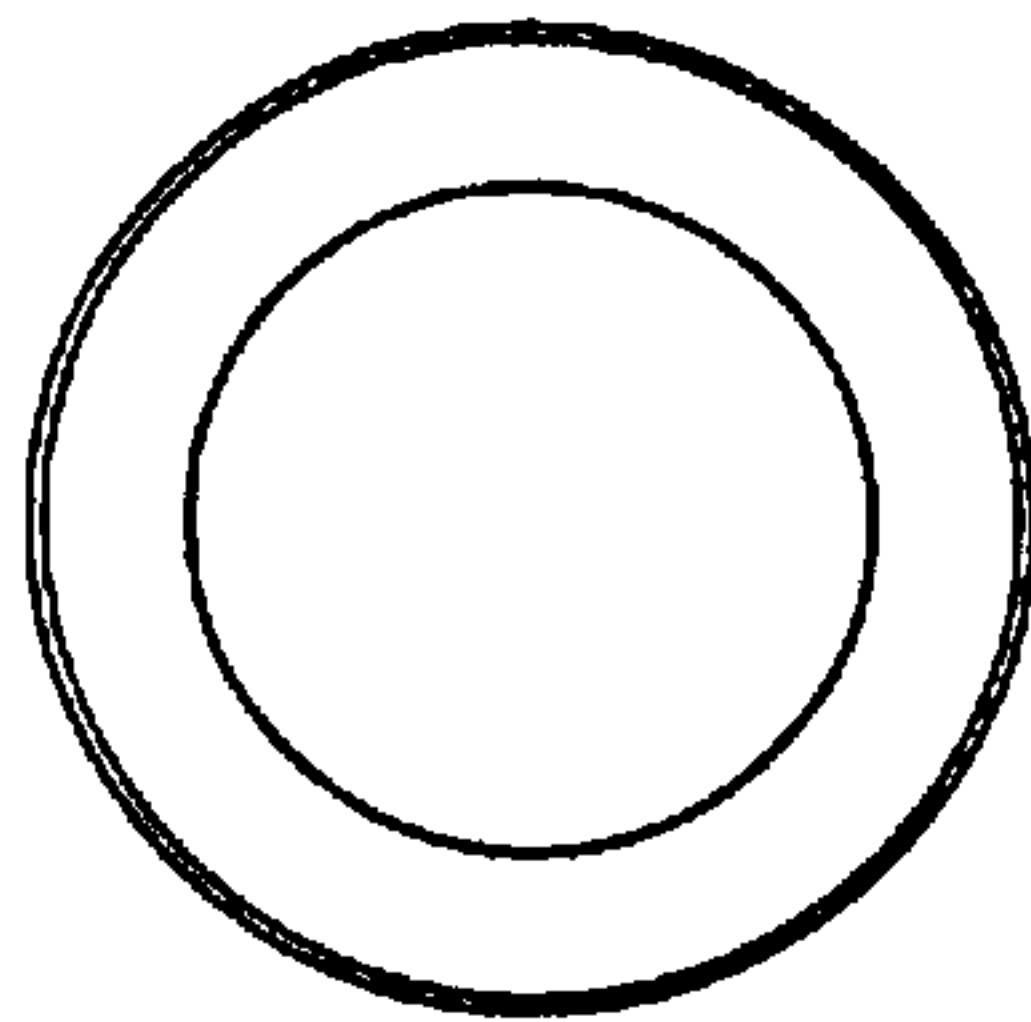

FIG.14

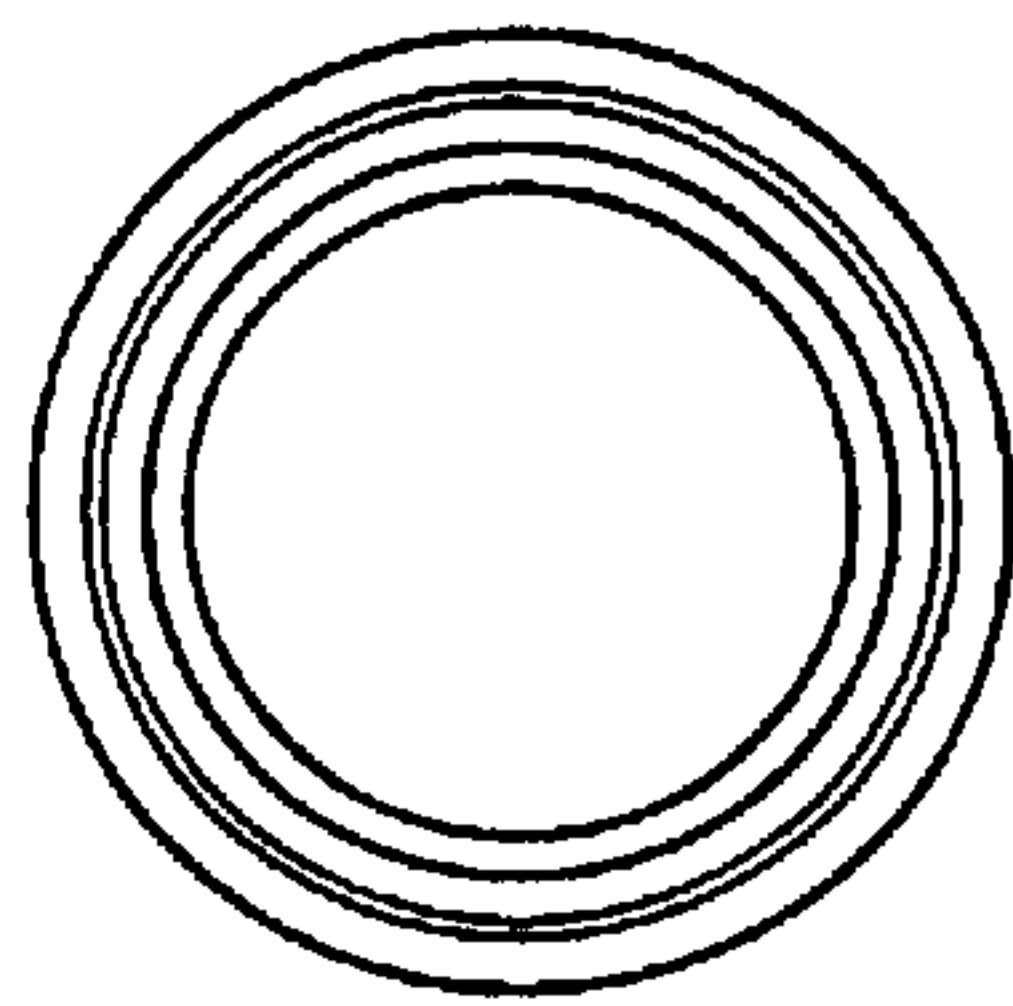

FIG.15

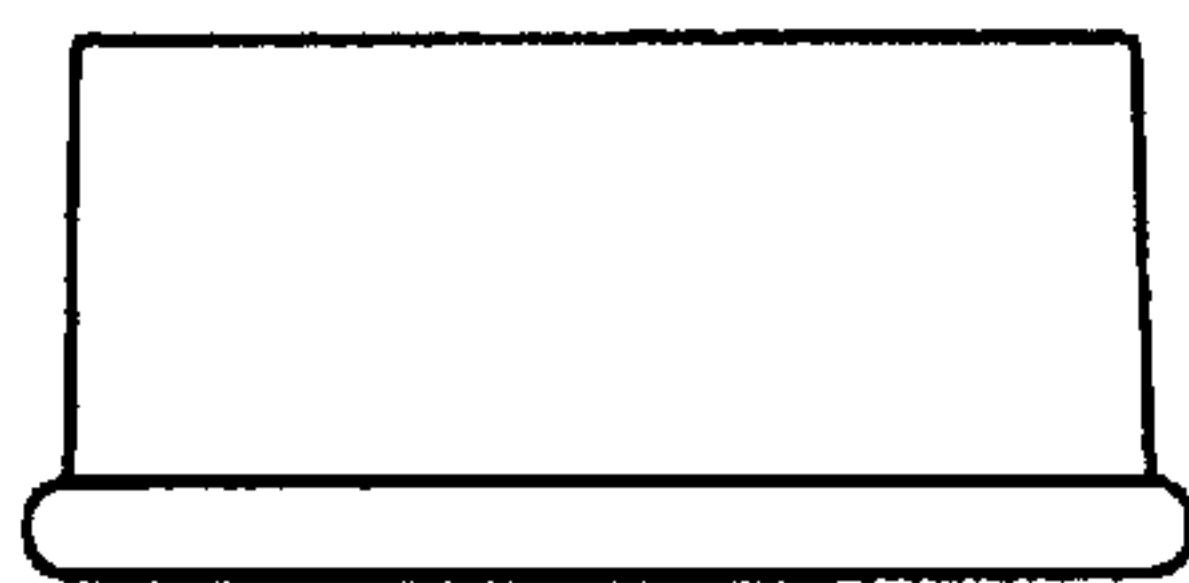

FIG.16

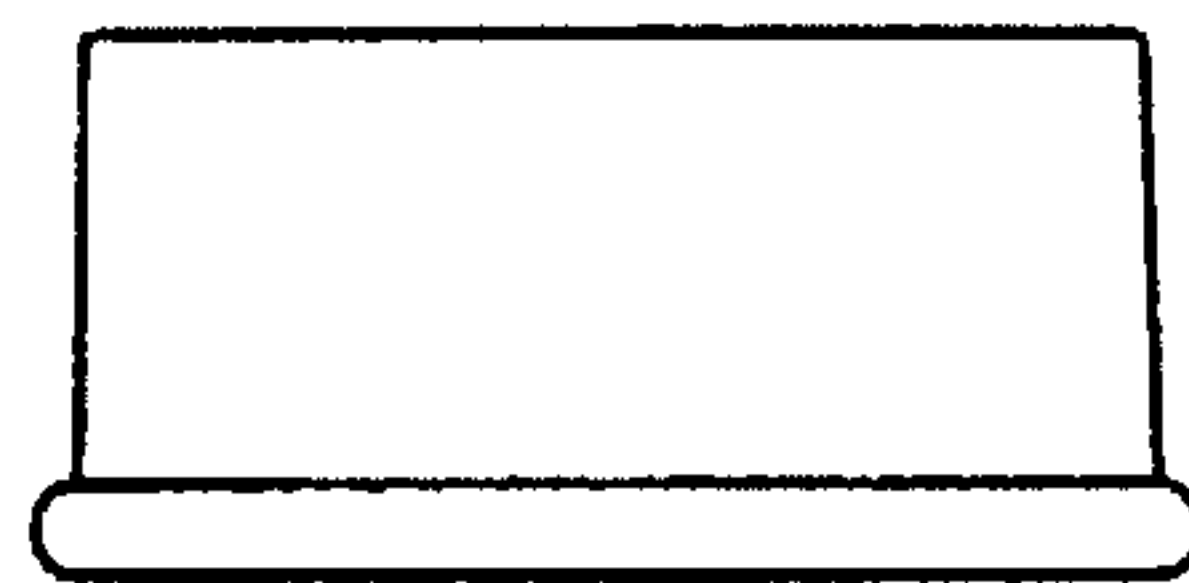

FIG.17



FIG.18

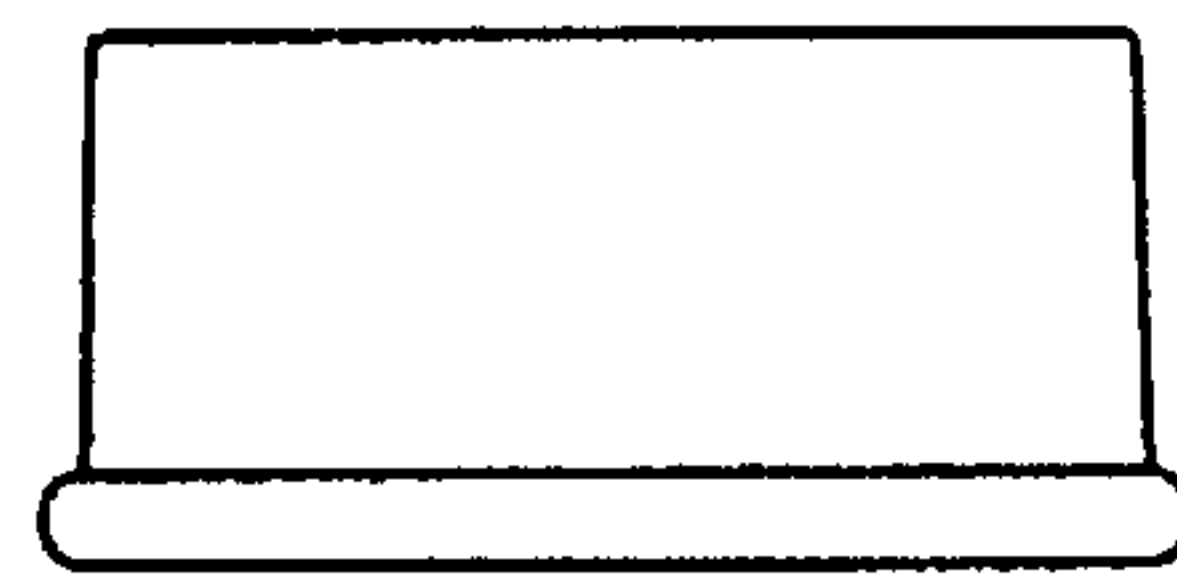

FIG.19

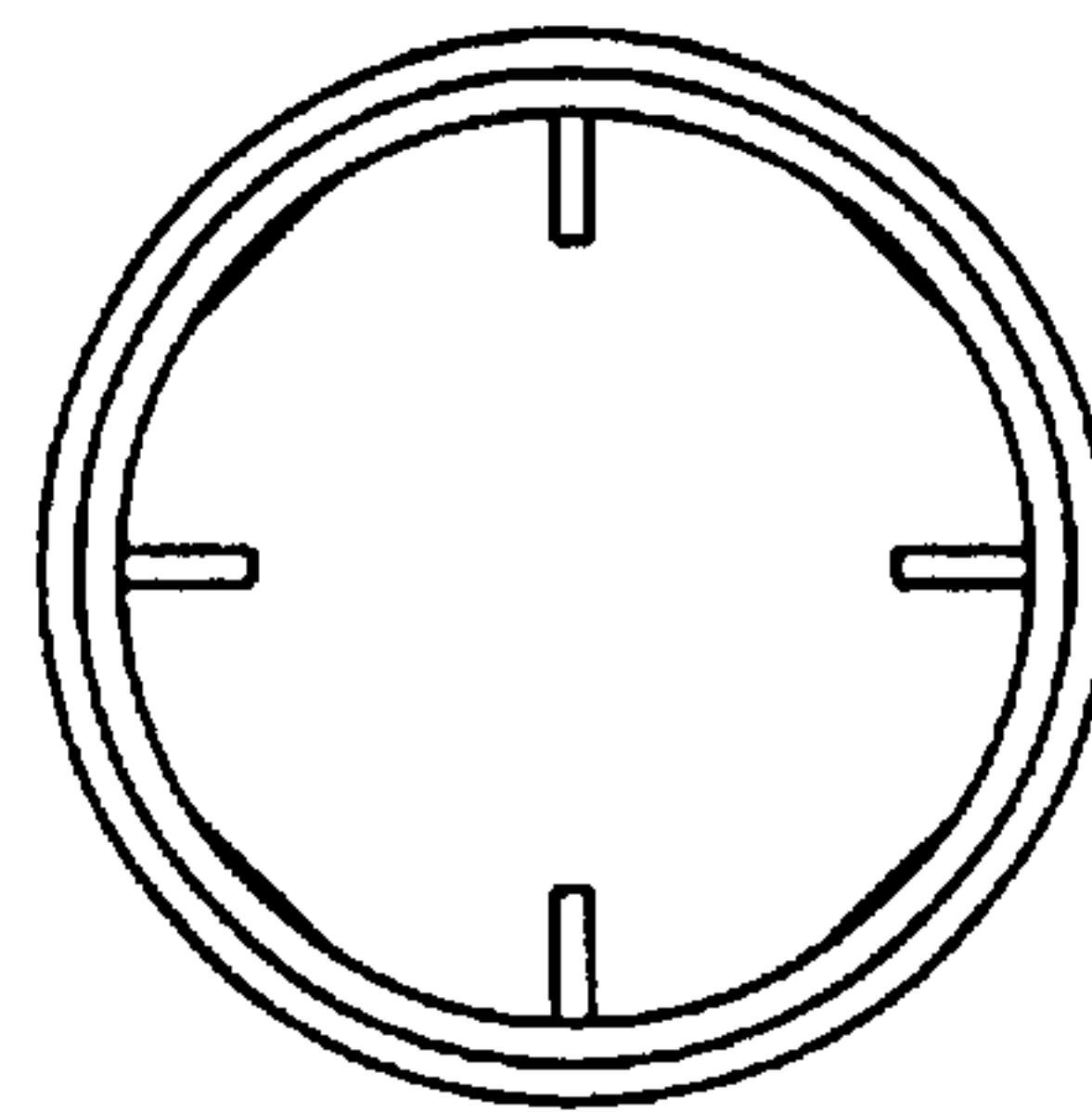

FIG.20

