

US00D507566S

(12) **United States Design Patent**
Leisinger et al.

(10) **Patent No.:** **US D507,566 S**
(45) **Date of Patent:** **** Jul. 19, 2005**

(54) **TERMINAL**

(75) Inventors: **Roger Leisinger**, Zürich (CH); **Bruno Mattle**, Uster (CH); **Hansjürg Rotach**, Effretikon (CH); **Patrik Morf**, Nänikon (CH); **Hansruedi Künzi**, Greifensee (CH); **Yves Marmier**, La Chaux-de-Fonds (CH)

(73) Assignee: **Mettler-Toledo GmbH**, Greifensee (CH)

(**) Term: **14 Years**

(21) Appl. No.: **29/213,542**

(22) Filed: **Sep. 20, 2004**

Related U.S. Application Data

(62) Division of application No. 29/193,193, filed on Nov. 6, 2003, now Pat. No. Des. 498,474.

(30) **Foreign Application Priority Data**

May 9, 2003 (WO) 24054 1001

(51) **LOC (8) Cl.** **14-02**

(52) **U.S. Cl.** **D14/336**

(58) **Field of Search** D14/341-346,
D14/336, 337, 374, 339, 388; 345/173,
104, 156, 168, 169; 361/680-686, 690-696

(56) **References Cited**

U.S. PATENT DOCUMENTS

4,862,151 A 8/1989 Grauz et al.

D304,032 S 10/1989 Fine et al.
D319,434 S 8/1991 Lund
D336,464 S 6/1993 Clough et al.
D340,701 S 10/1993 Takeuchi
D349,690 S 8/1994 Miyata et al.
D395,285 S 6/1998 Allon
D498,474 S * 11/2004 Leisinger et al. D14/336

* cited by examiner

Primary Examiner—Freda D. Nunn

(74) *Attorney, Agent, or Firm*—Burns, Doane, Swecker & Mathis, L.L.P.

(57) **CLAIM**

The ornamental design for a terminal, as shown and described.

DESCRIPTION

FIG. 1 is a front, top perspective view of a terminal showing our new design.

FIG. 2 is a top plan view thereof.

FIG. 3 is a bottom plan view thereof.

FIG. 4 is a front elevational view thereof.

FIG. 5 is a rear elevational view thereof.

FIG. 6 is a left side elevational view thereof; and,

FIG. 7 is a right side elevational view thereof.

1 Claim, 2 Drawing Sheets

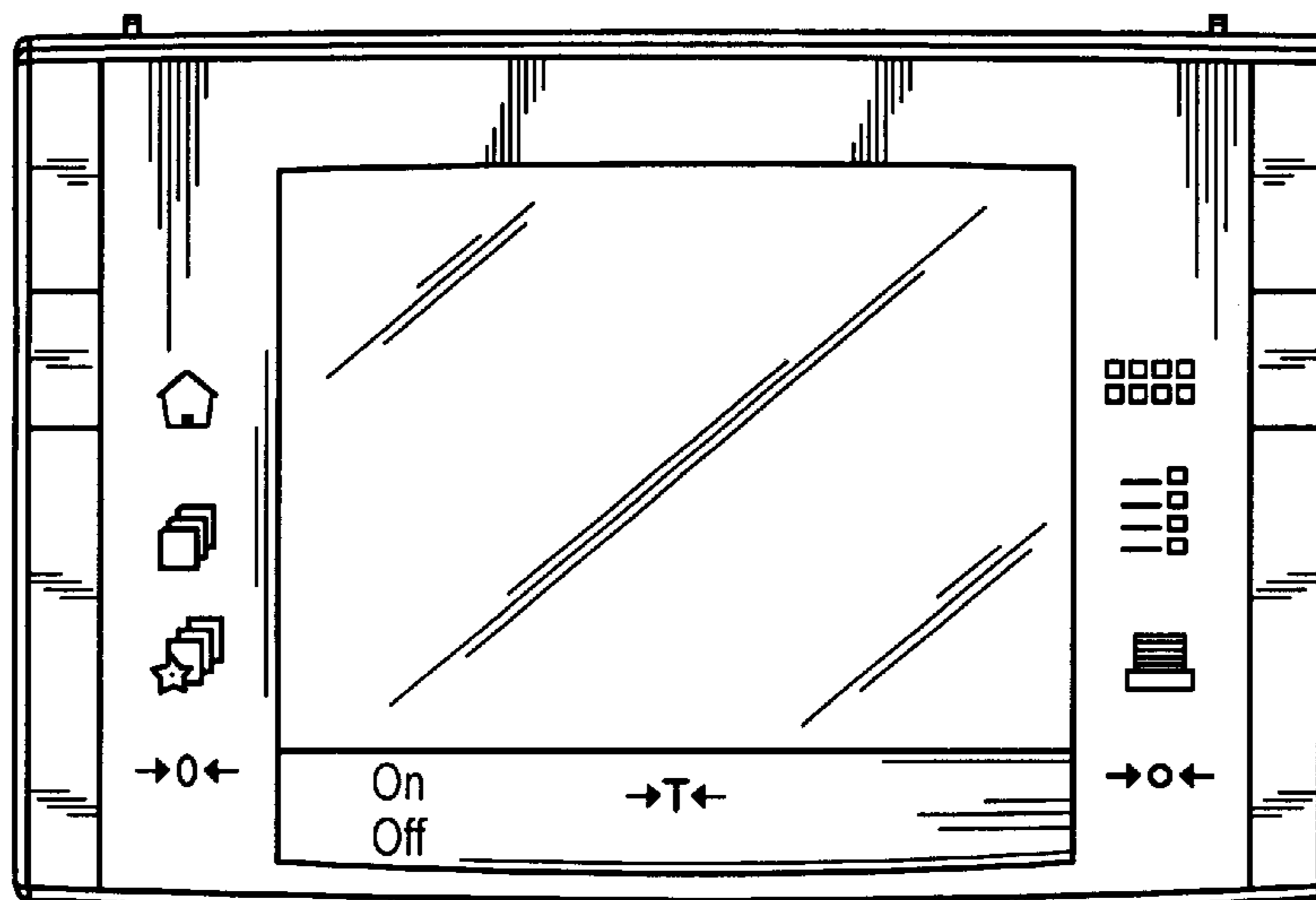

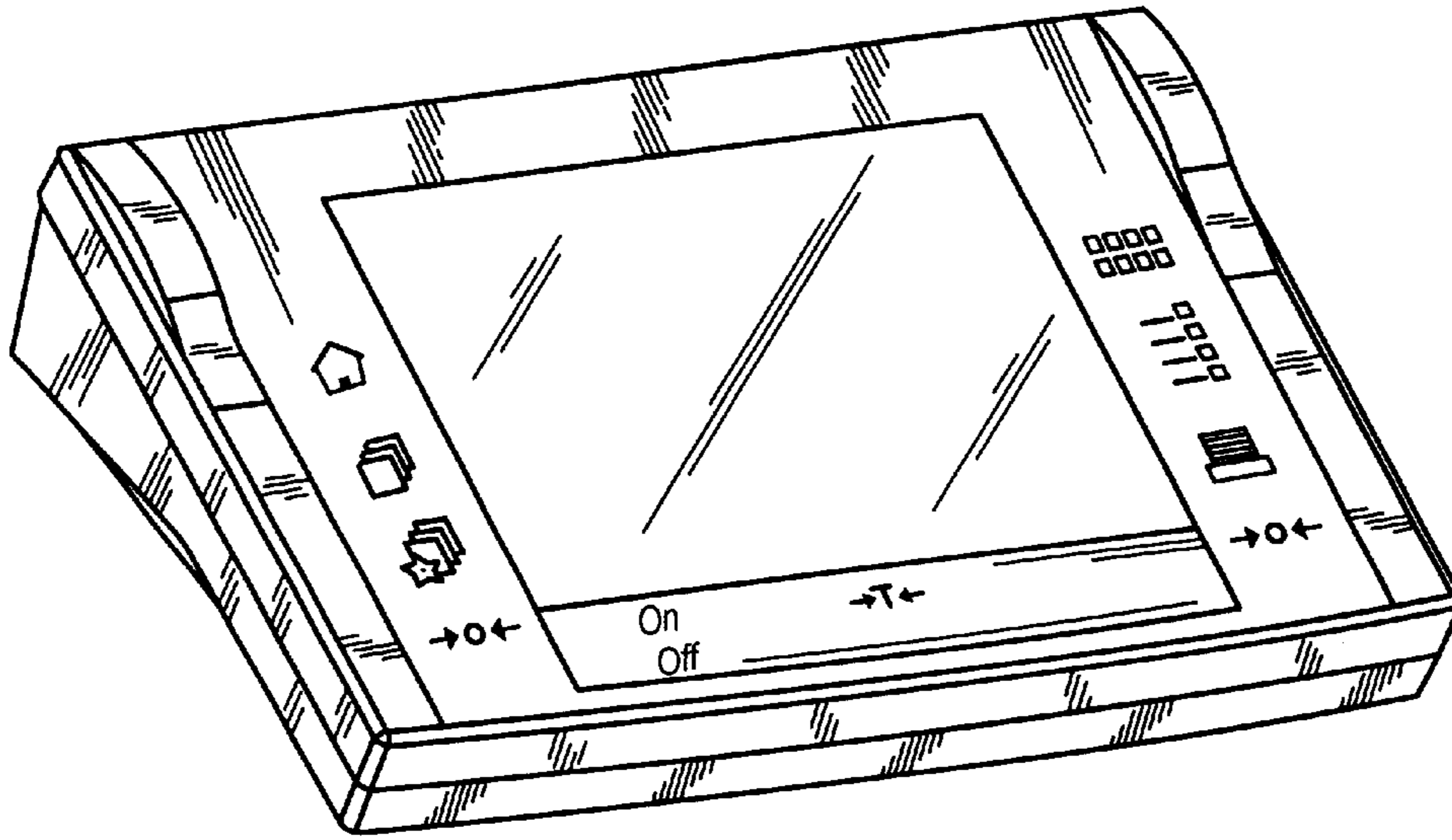

FIG. 1

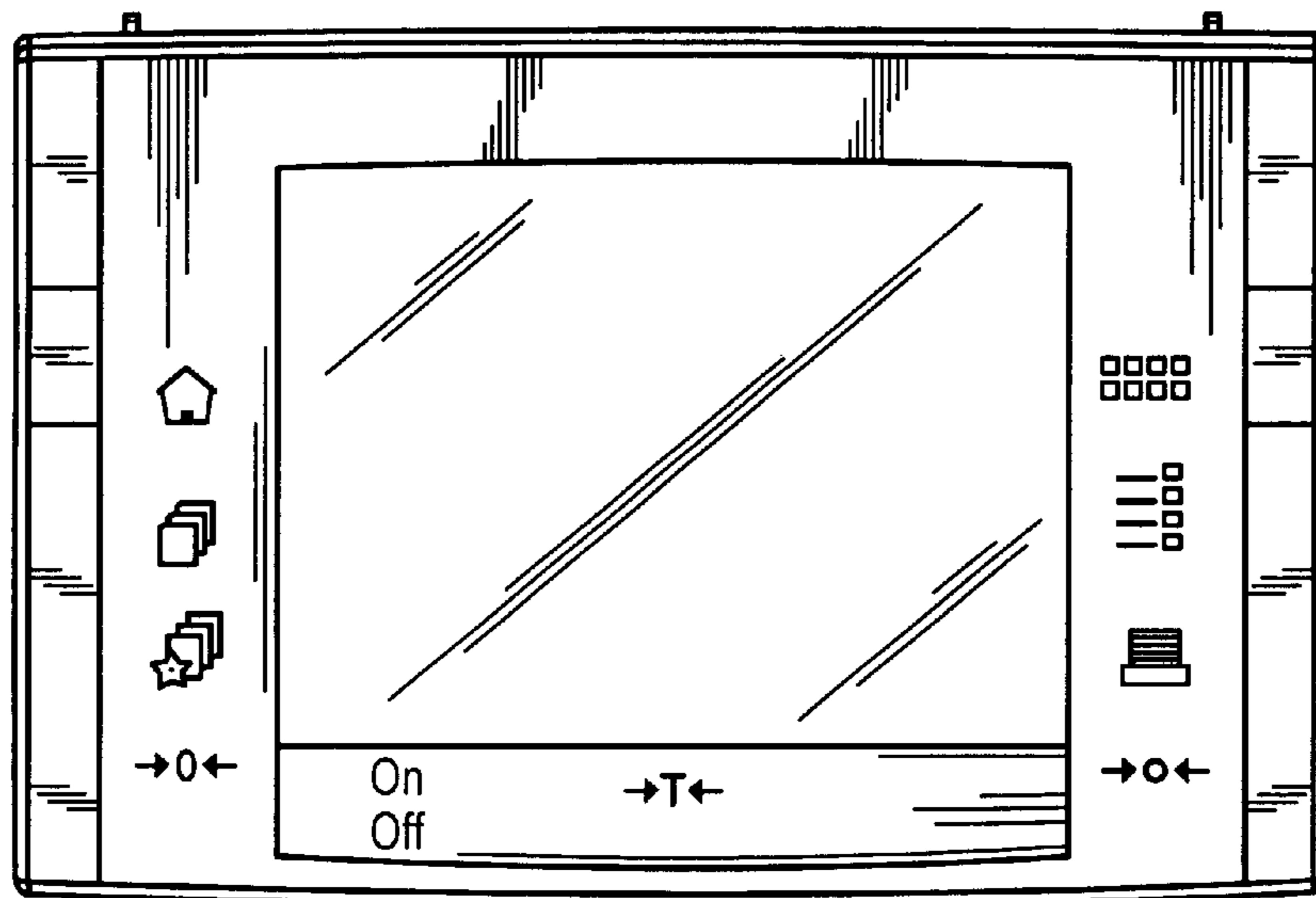

FIG. 2

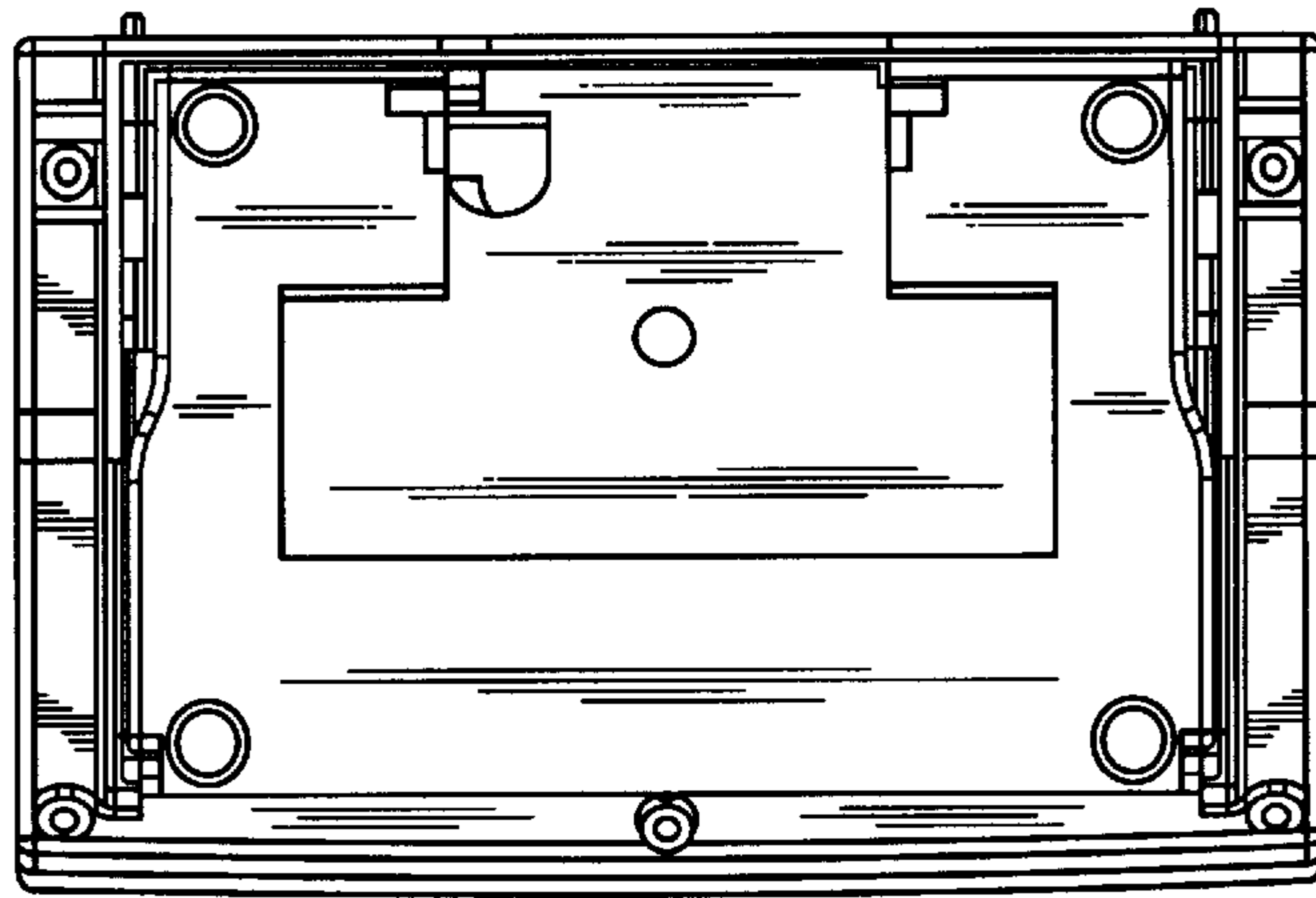

FIG. 3

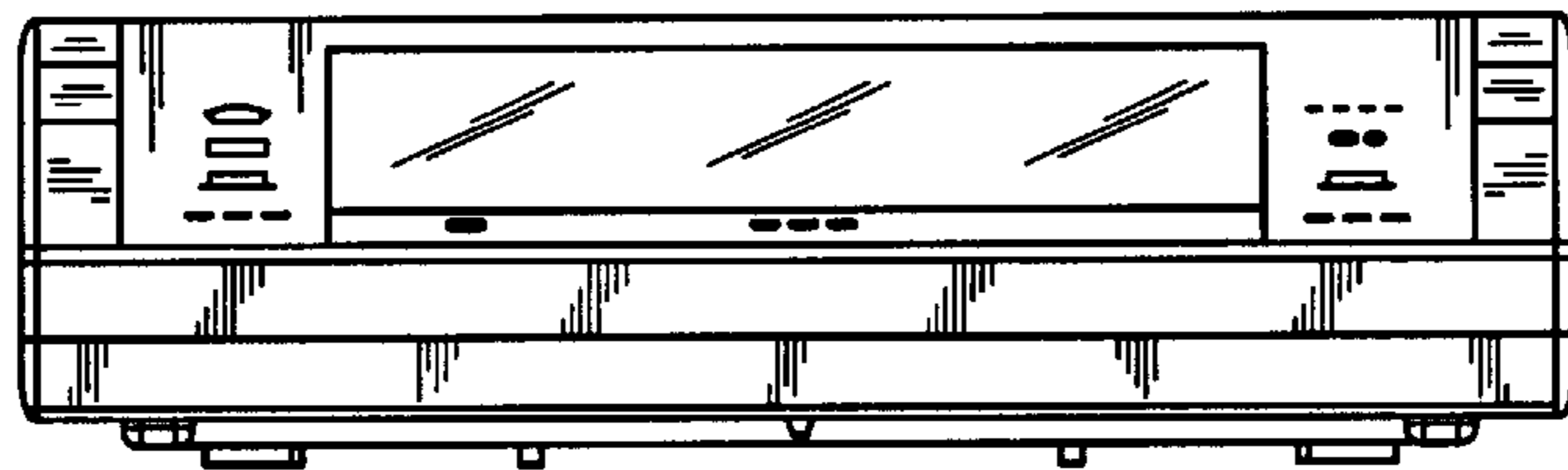

FIG. 4

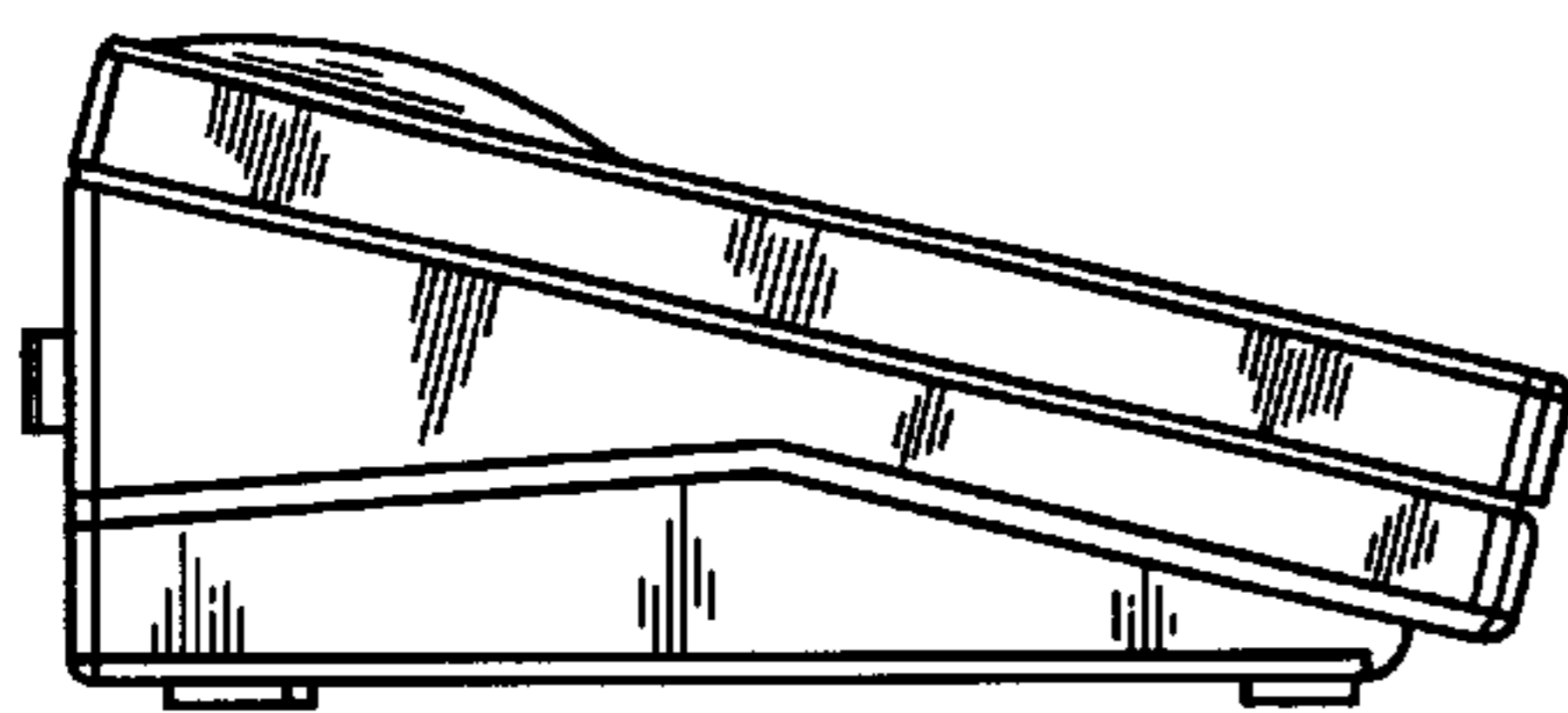

FIG. 6

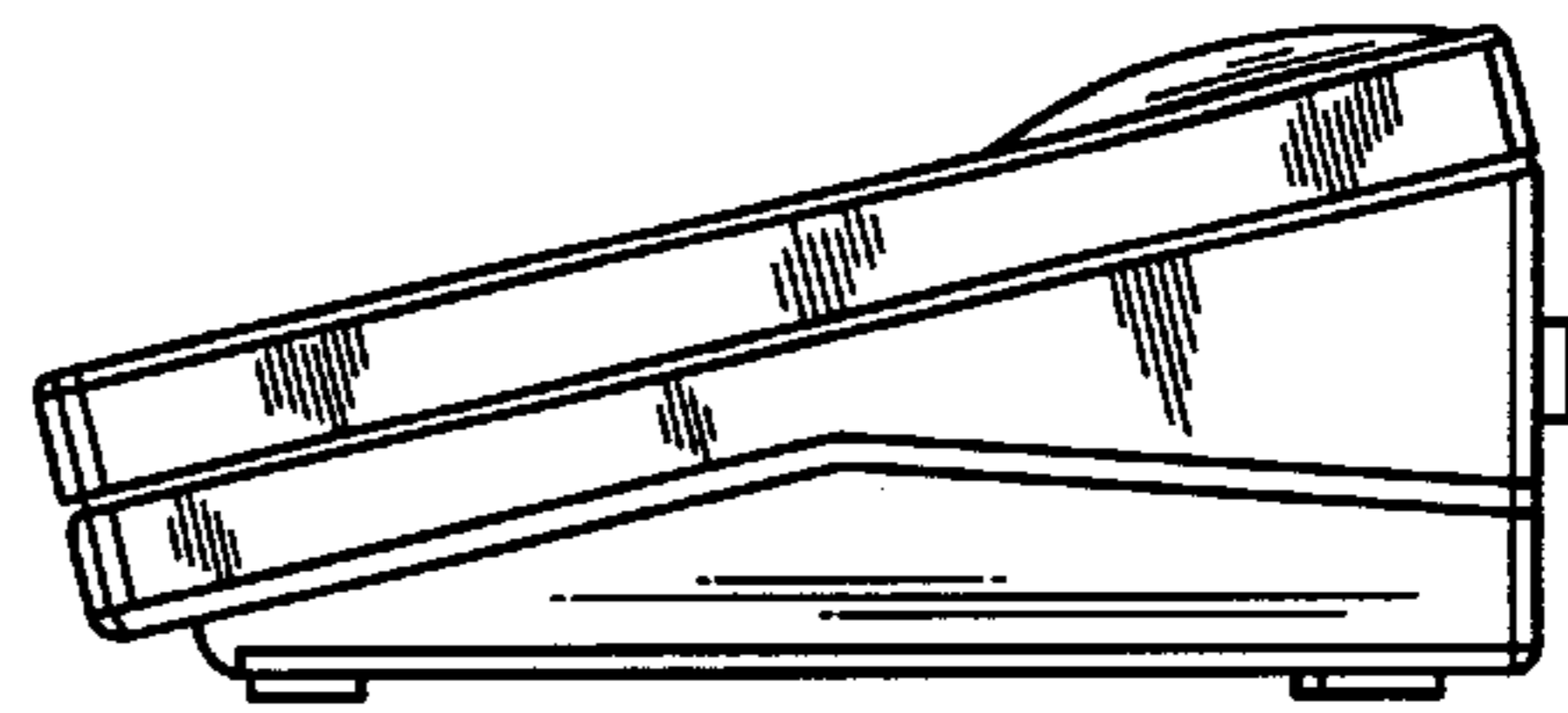

FIG. 7

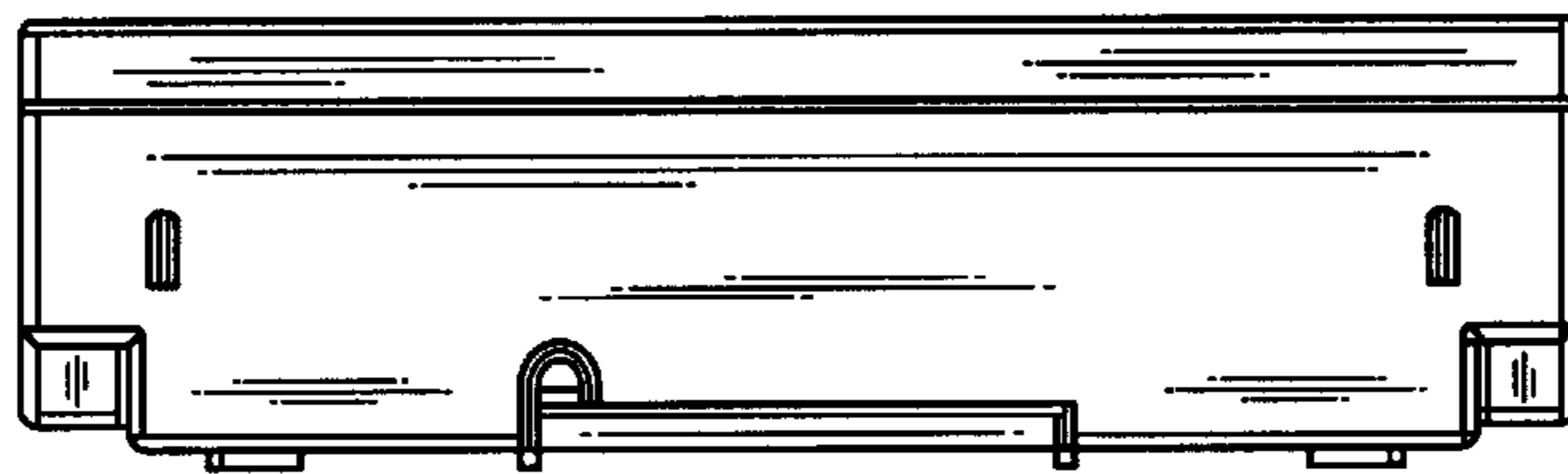

FIG. 5