

US00D507549S

(12) **United States Design Patent** (10) **Patent No.:** **US D507,549 S**
Moss (45) **Date of Patent:** **** Jul. 19, 2005**

(54) **PORTION OF A HANDSET**
(75) **Inventor:** **Aaron Moss, Farnborough (GB)**
(73) **Assignee:** **Nokia Corporation, Espoo (FI)**
(**) **Term:** **14 Years**
(21) **Appl. No.:** **29/202,432**
(22) **Filed:** **Mar. 31, 2004**

D492,276 S * 6/2004 Walliser et al. D14/138
D492,660 S * 7/2004 Kim et al. D14/138
D494,561 S 8/2004 Kagami
D494,949 S * 8/2004 Arnholt et al. D14/138
D494,950 S * 8/2004 Keunecke D14/138
D496,641 S * 9/2004 Seo D14/138
D496,921 S * 10/2004 Hwang D14/138
D497,892 S * 11/2004 Peng D14/138
2002/0032011 A1 * 3/2002 Park 455/90
2003/0038787 A1 * 2/2003 Nishiyama 345/169
2004/0180703 A1 * 9/2004 Kim et al. 455/575.1

(30) **Foreign Application Priority Data**

Oct. 23, 2003 (FI) M20030251

(51) **LOC (8) Cl.** **14-03**
(52) **U.S. Cl.** **D14/138; D14/248**
(58) **Field of Search** D14/137, 138,
D14/218, 147-148, 387, 247-248, 399,
426, 144, 240, 191, 341-347, 401, 388-340;
379/433.01-433.13, 419, 434, 428.01-428.04,
420.01-420.04, 440; D10/65, 68; 455/550.1-90.3;
D21/517, 329, 331, 333; D18/2, 7; 345/168,
169; D13/168

FOREIGN PATENT DOCUMENTS

WO DM/063 714 7/2003
WO DM/064 218 10/2003
WO DM/065 073 4/2004

* cited by examiner

Primary Examiner—Jeffrey Asch
(74) *Attorney, Agent, or Firm*—Banner & Witcoff, Ltd.

(57) **CLAIM**

The ornamental design for a front cover portion of a handset as shown and described.

DESCRIPTION

FIG. 1 is a bottom plan view of a front cover portion of a handset showing my new design;
FIG. 2 is a right side view thereof;
FIG. 3 is a front view thereof;
FIG. 4 is left side view thereof;
FIG. 5 is a top plan view thereof;
FIG. 6 is a perspective front view thereof;
FIG. 7 is a bottom plan view according to a second embodiment thereof directed to the visible aspects of the front cover portion of the handset of FIGS. 1-6 in an assembled handset embodiment;
FIG. 8 is a right side view thereof;
FIG. 9 is a front view thereof;
FIG. 10 is a left side view thereof;
FIG. 11 is a top plan view thereof; and,
FIG. 12 is a perspective front view thereof.
The broken line showing of the remainder of the handset in FIGS. 7-12 is for illustrative purposes only and forms no part of the claimed design.

(56) **References Cited**

U.S. PATENT DOCUMENTS

D407,722 S * 4/1999 Nagano et al. D14/138
6,006,074 A * 12/1999 De Larminat et al. ... 455/575.1
D426,531 S * 6/2000 Chikaraishi et al. D14/138
D429,241 S * 8/2000 Collins D14/248
D456,394 S * 4/2002 Laverick et al. D14/248
D459,332 S * 6/2002 Peiker D14/147
D465,483 S * 11/2002 Nuovo D14/248
D469,748 S * 2/2003 Ribeiro et al. D14/138
D475,034 S * 5/2003 Arbisi et al. D14/138
D479,216 S * 9/2003 Ho-Cheun et al. D14/138
D479,514 S * 9/2003 Chan D14/138
D480,374 S * 10/2003 Toor et al. D14/138
D484,475 S * 12/2003 Sheu D14/138
D484,477 S * 12/2003 Salmi D14/138
D485,246 S * 1/2004 Johansson et al. D14/138
D485,819 S * 1/2004 Ahlgren D14/138
D487,438 S * 3/2004 Sheu D14/138
D488,789 S * 4/2004 Lee D14/138
D492,274 S * 6/2004 Widiawan D14/138

1 Claim, 6 Drawing Sheets

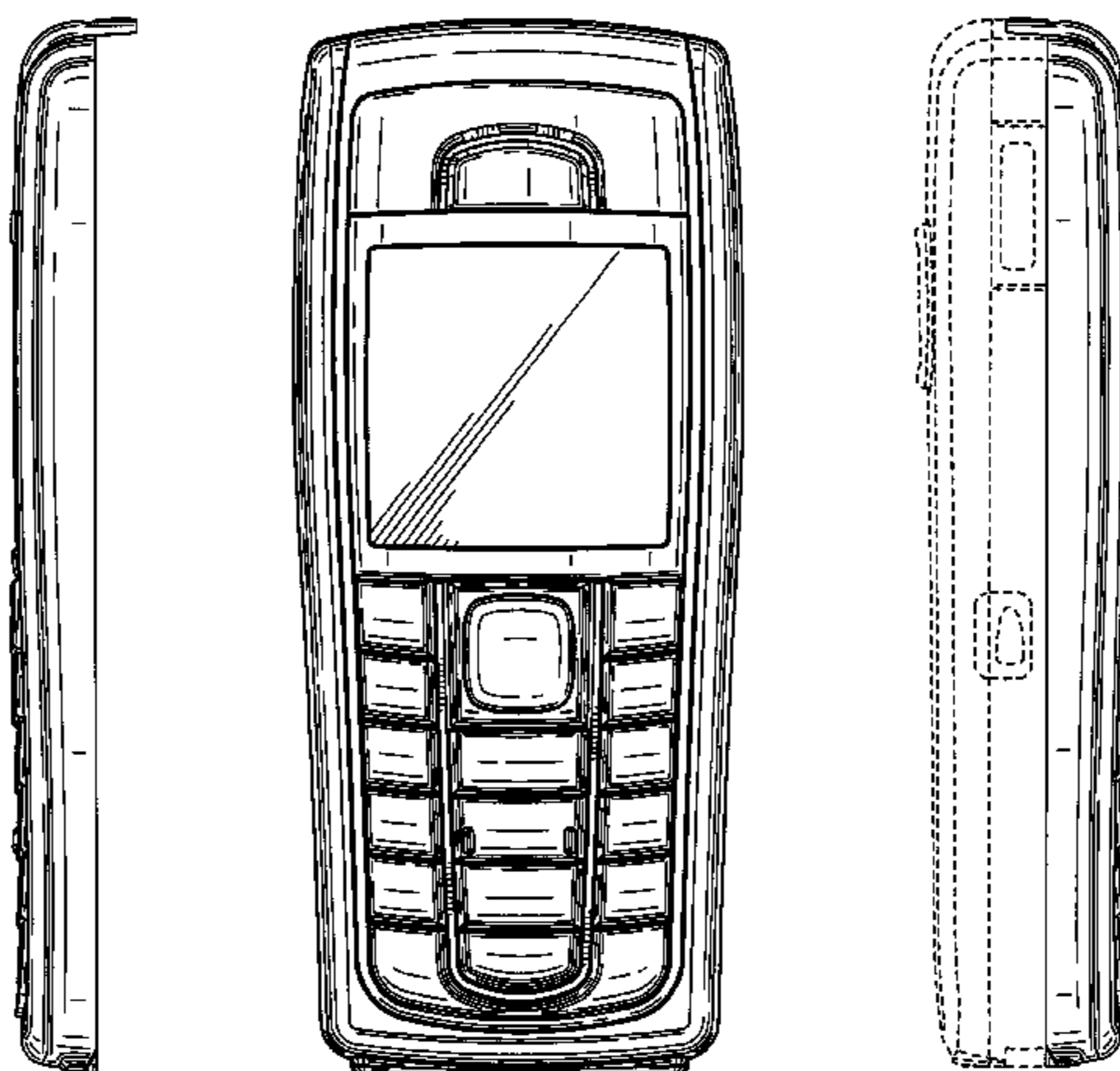

FIG. 1

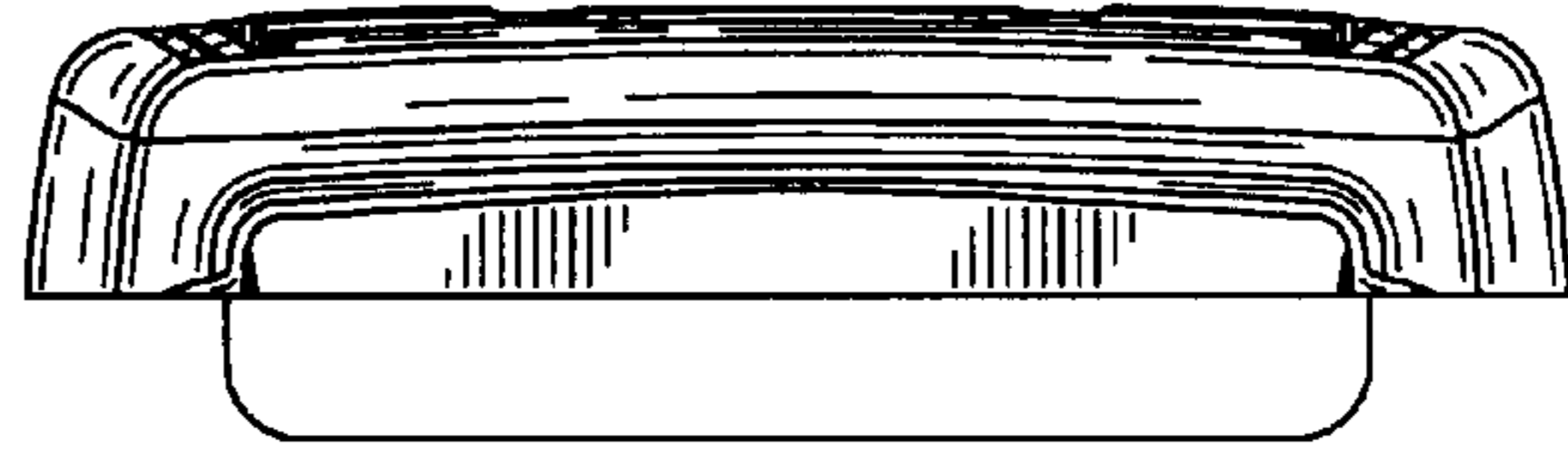

FIG. 2

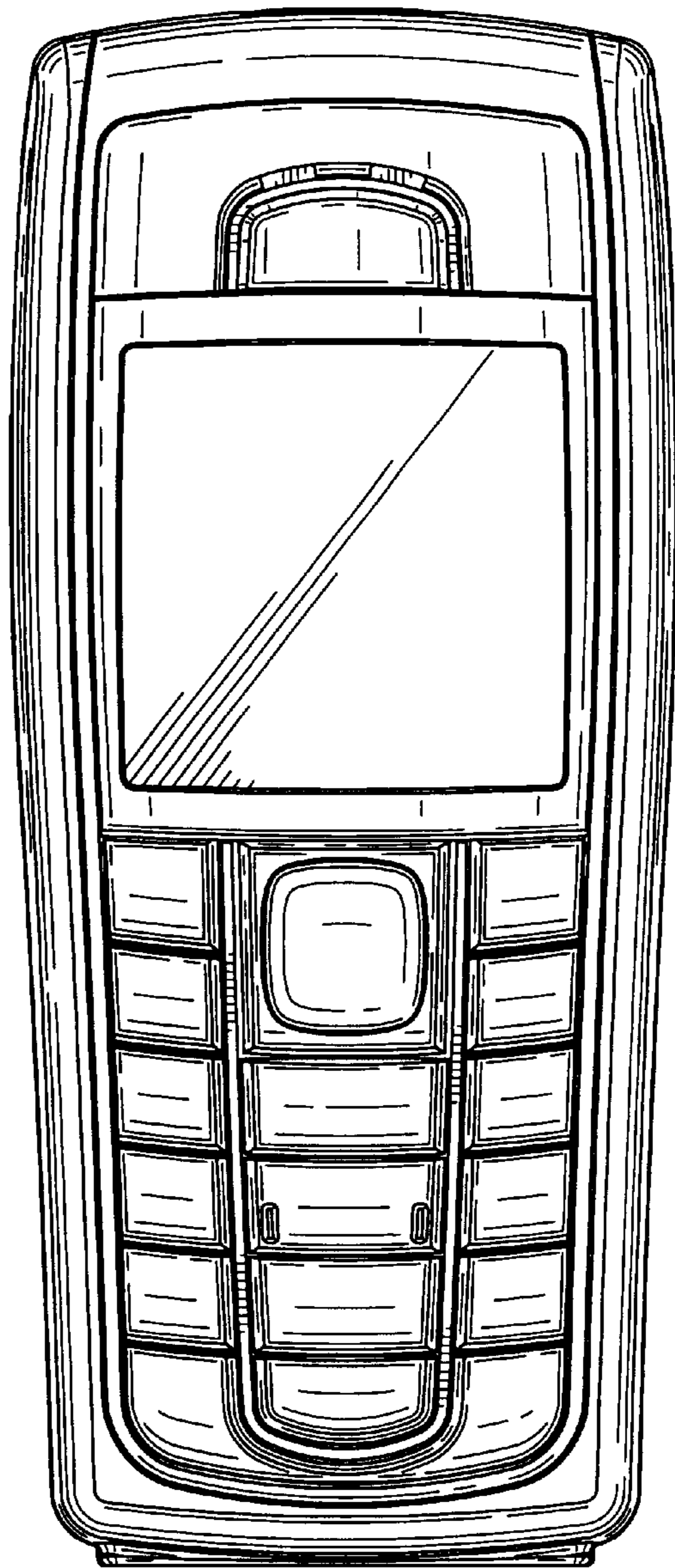

FIG. 3



FIG. 4

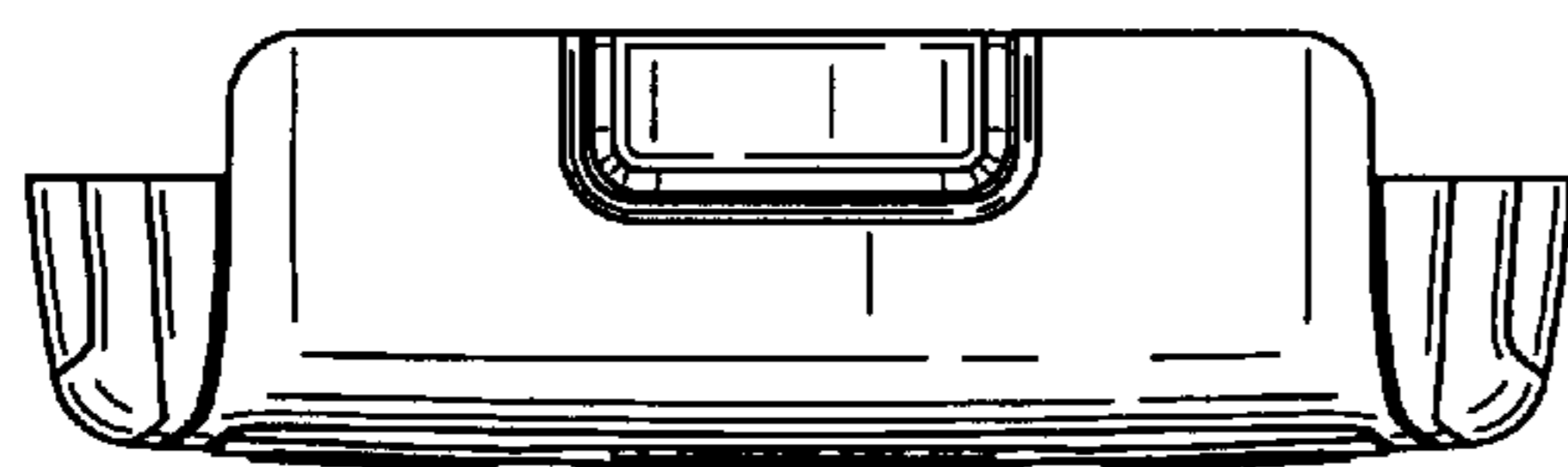

FIG. 5



FIG. 6

FIG. 7

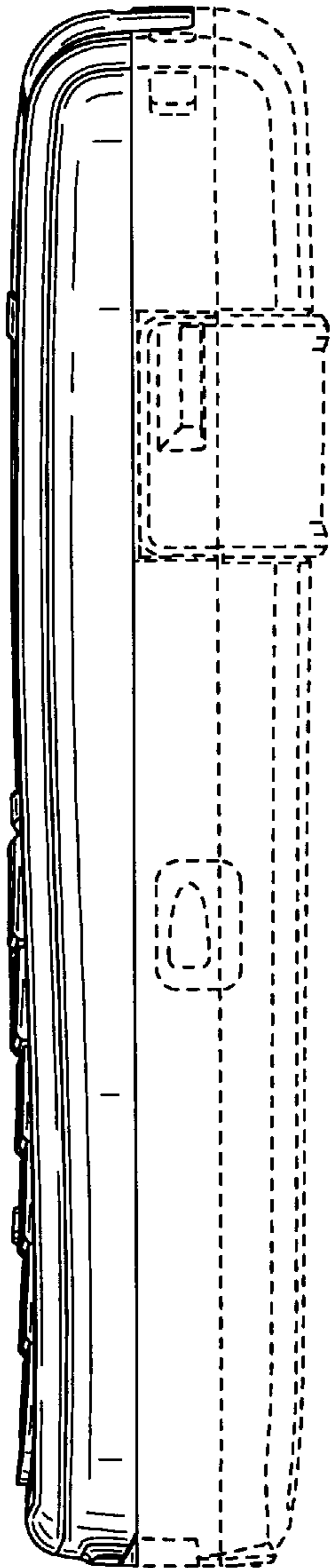
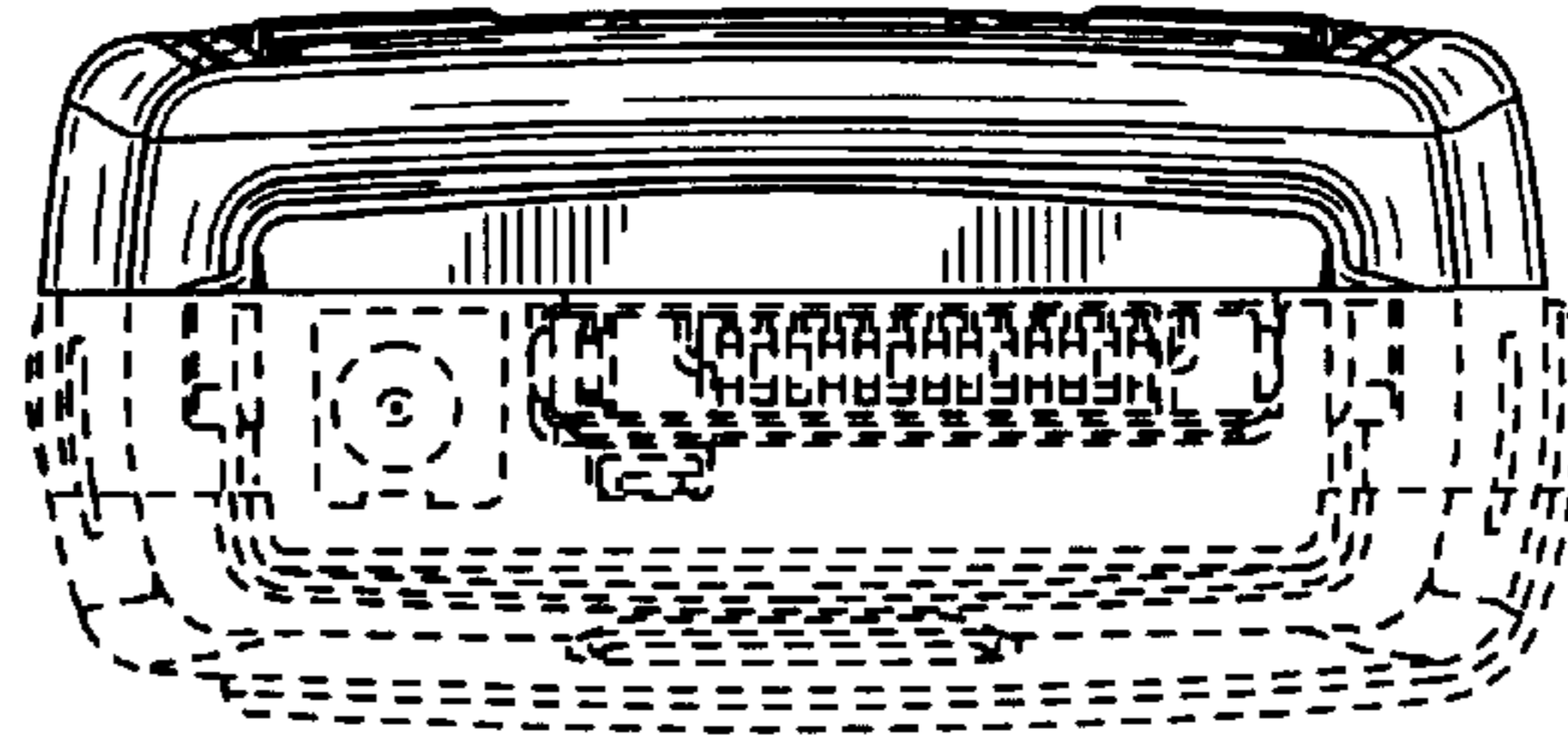

FIG. 8

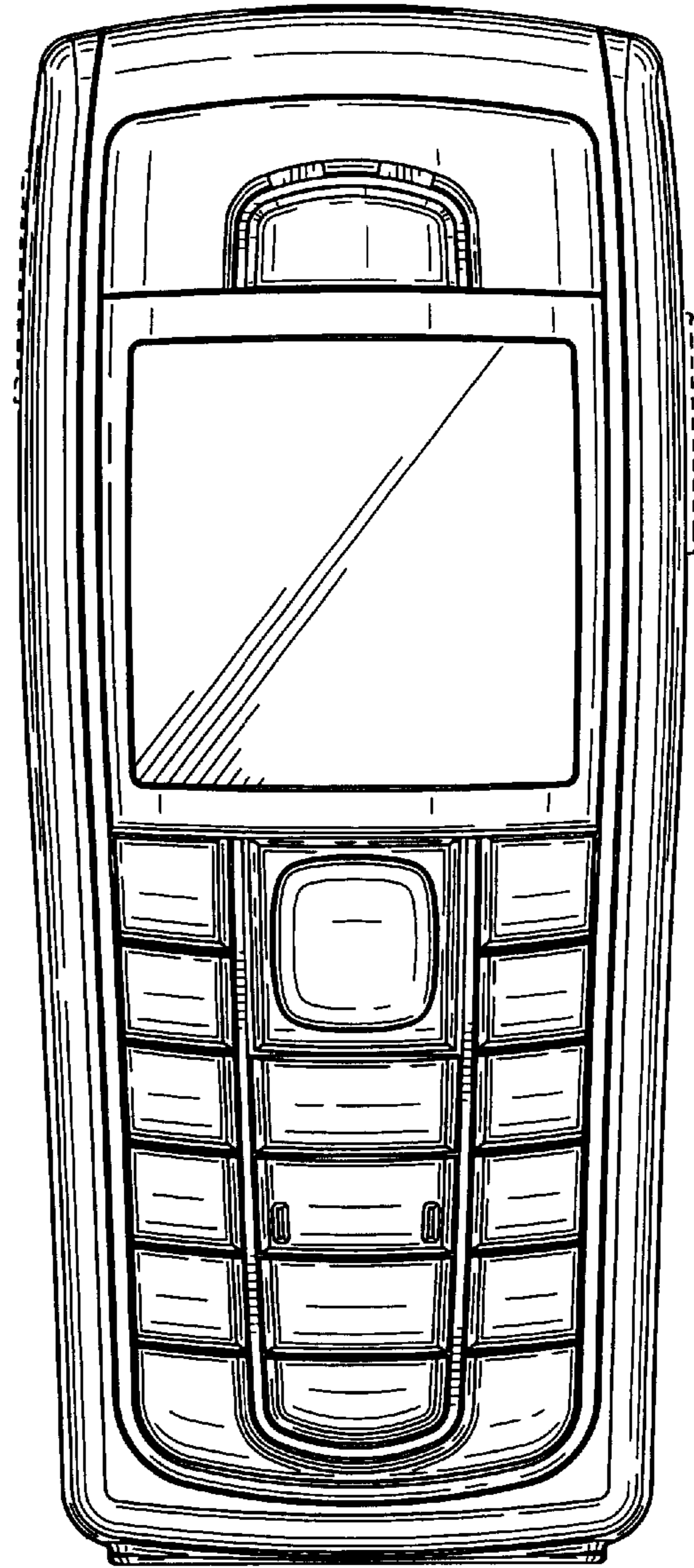

FIG. 9

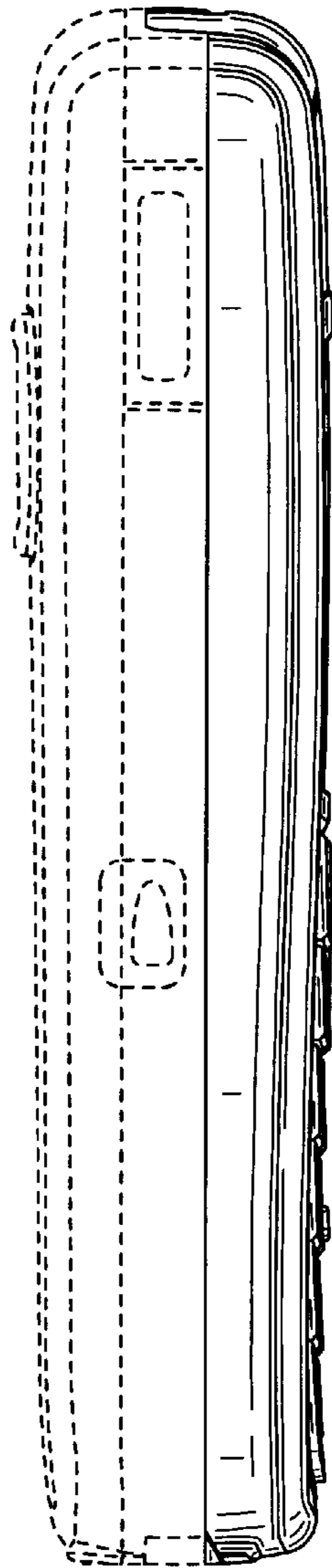

FIG. 10

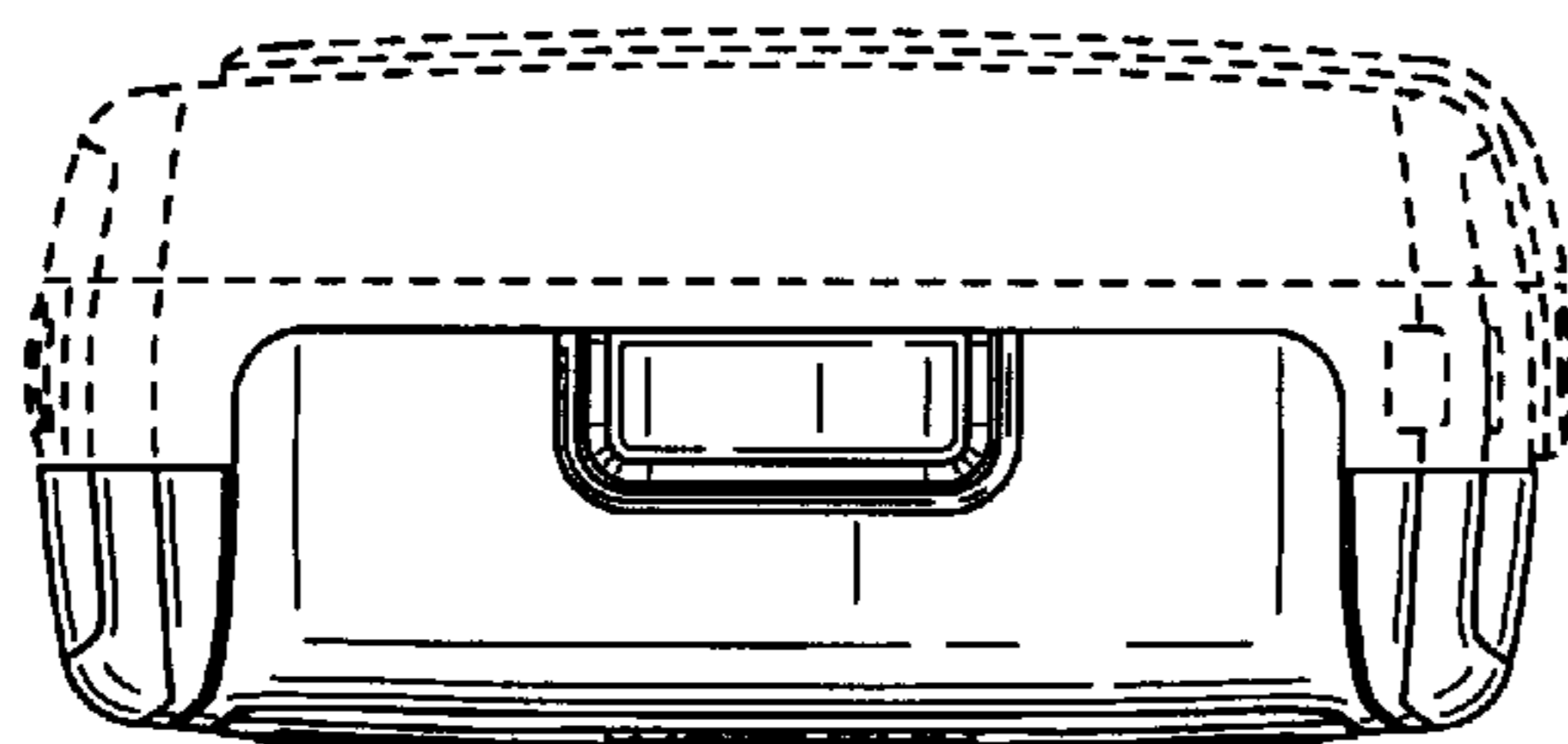

FIG. 11

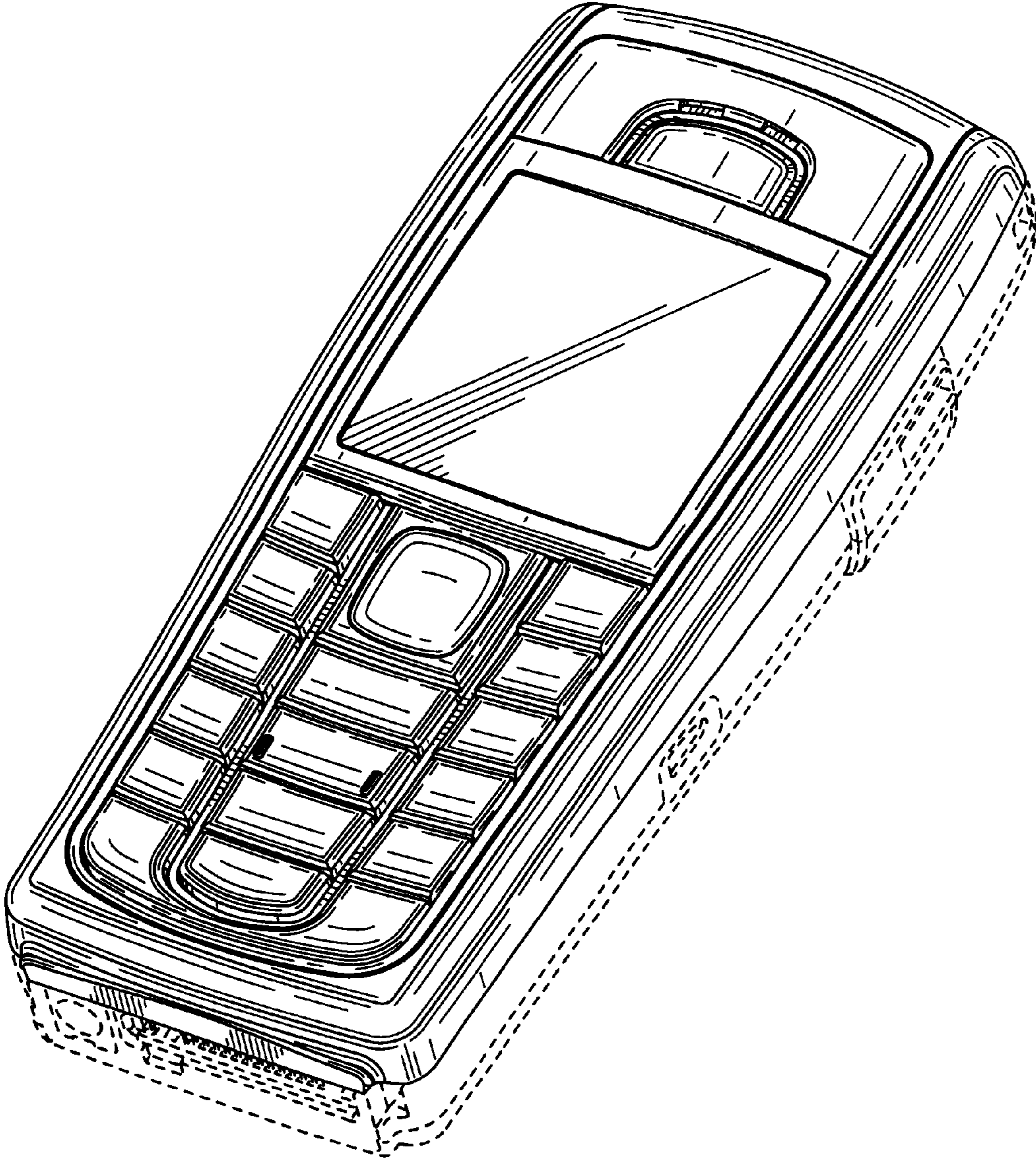

FIG. 12

UNITED STATES PATENT AND TRADEMARK OFFICE
CERTIFICATE OF CORRECTION

PATENT NO. : Des. 507,549 S
DATED : July 19, 2005
INVENTOR(S) : Aaron Moss

Page 1 of 1

It is certified that error appears in the above-identified patent and that said Letters Patent is hereby corrected as shown below:

Title page.

Item [54], Title, "PORTION OF HANDSET" has been replaced with -- **FRONT COVER PORTION OF A HANDSET** --.

Signed and Sealed this

Thirtieth Day of August, 2005

A handwritten signature in black ink, reading "Jon W. Dudas". The signature is written in a cursive style with a large, looped initial "J".

JON W. DUDAS

Director of the United States Patent and Trademark Office