



US00D507497S

(12) **United States Design Patent**
Liao

(10) **Patent No.:** **US D507,497 S**
(45) **Date of Patent:** **** Jul. 19, 2005**

- (54) **WATCH CASE**
- (75) **Inventor:** **Ren Cong Liao, Sherzhen (CN)**
- (73) **Assignee:** **New Heritage Limited, Hung Hom Kln. (HK)**
- (**) **Term:** **14 Years**
- (21) **Appl. No.:** **29/215,721**
- (22) **Filed:** **Oct. 22, 2004**
- (51) **LOC (8) Cl. 10-02**
- (52) **U.S. Cl. D10/30**
- (58) **Field of Search D10/30-39; 368/280-282, 368/276-277, 285, 293-294**

D485,767 S * 1/2004 Lalo D10/30
 D494,477 S * 8/2004 Lalo D10/30

* cited by examiner

Primary Examiner—Nelson C. Holtje
 (74) *Attorney, Agent, or Firm*—Thomas I. Rozsa; Tony D. Chen

(57) **CLAIM**

The ornamental design for a watch case, as shown and described.

DESCRIPTION

FIG. 1 is a perspective view of a watch case when viewed from the right side, showing my new design;
 FIG. 2 is a perspective view when viewed from the left side;
 FIG. 3 is a top plan view;
 FIG. 4 is a bottom plan view;
 FIG. 5 is a side elevational view when viewed from the right side;
 FIG. 6 is a side elevational view when viewed from the left side;
 FIG. 7 is a top end view; and,
 FIG. 8 is a bottom end view, showing my new design.

(56) **References Cited**

U.S. PATENT DOCUMENTS

- 4,218,873 A * 8/1980 Lang 368/281
- 4,391,533 A * 7/1983 Waki 368/281
- D370,638 S * 6/1996 Oba D10/30
- D388,332 S * 12/1997 Perrin et al. D10/32
- D403,599 S * 1/1999 Emmenegger D10/39
- D410,198 S * 5/1999 Hysek D10/30
- D423,374 S * 4/2000 Deleskiewicz D10/32
- D474,700 S * 5/2003 Court D10/39

1 Claim, 2 Drawing Sheets

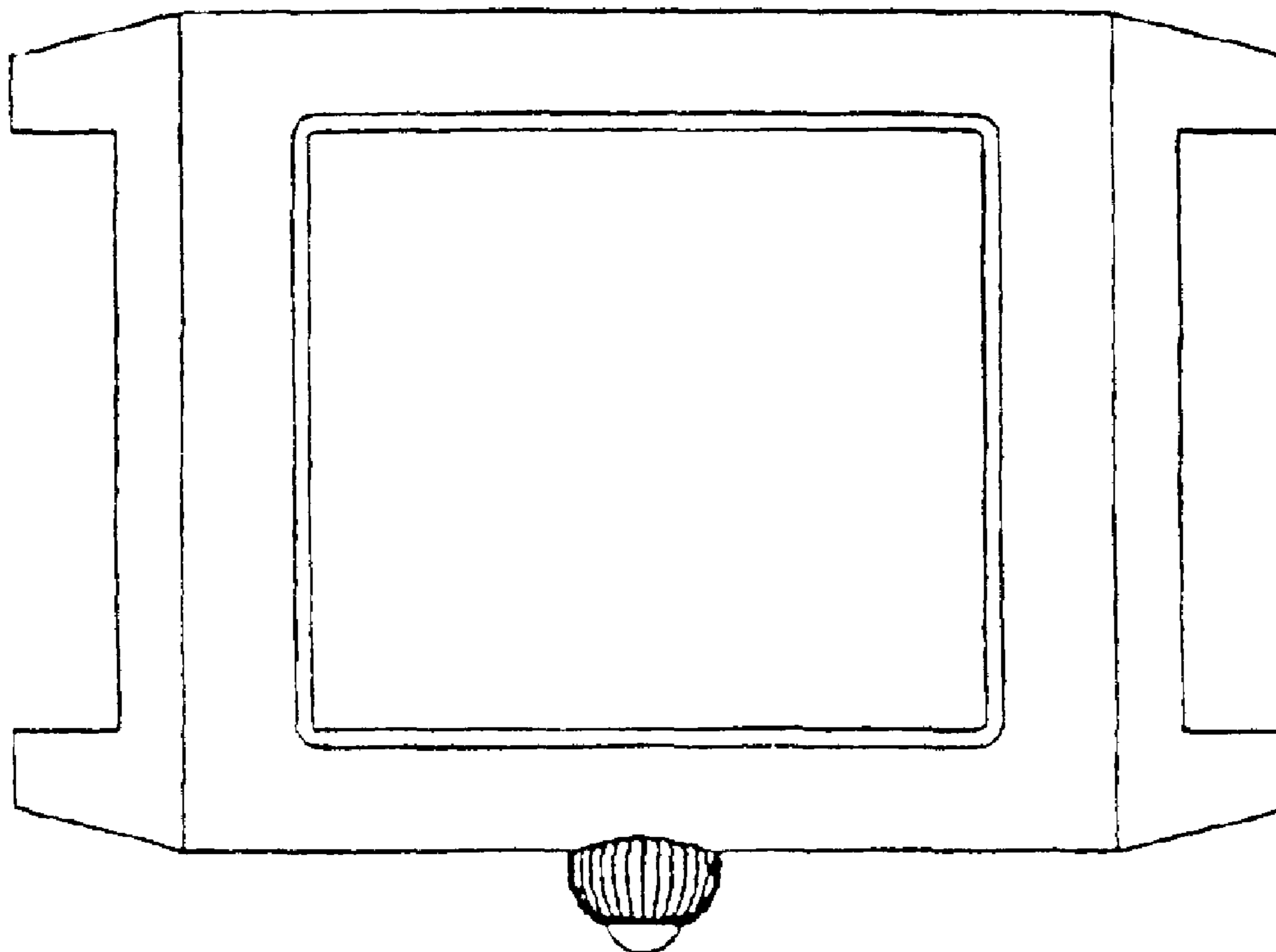

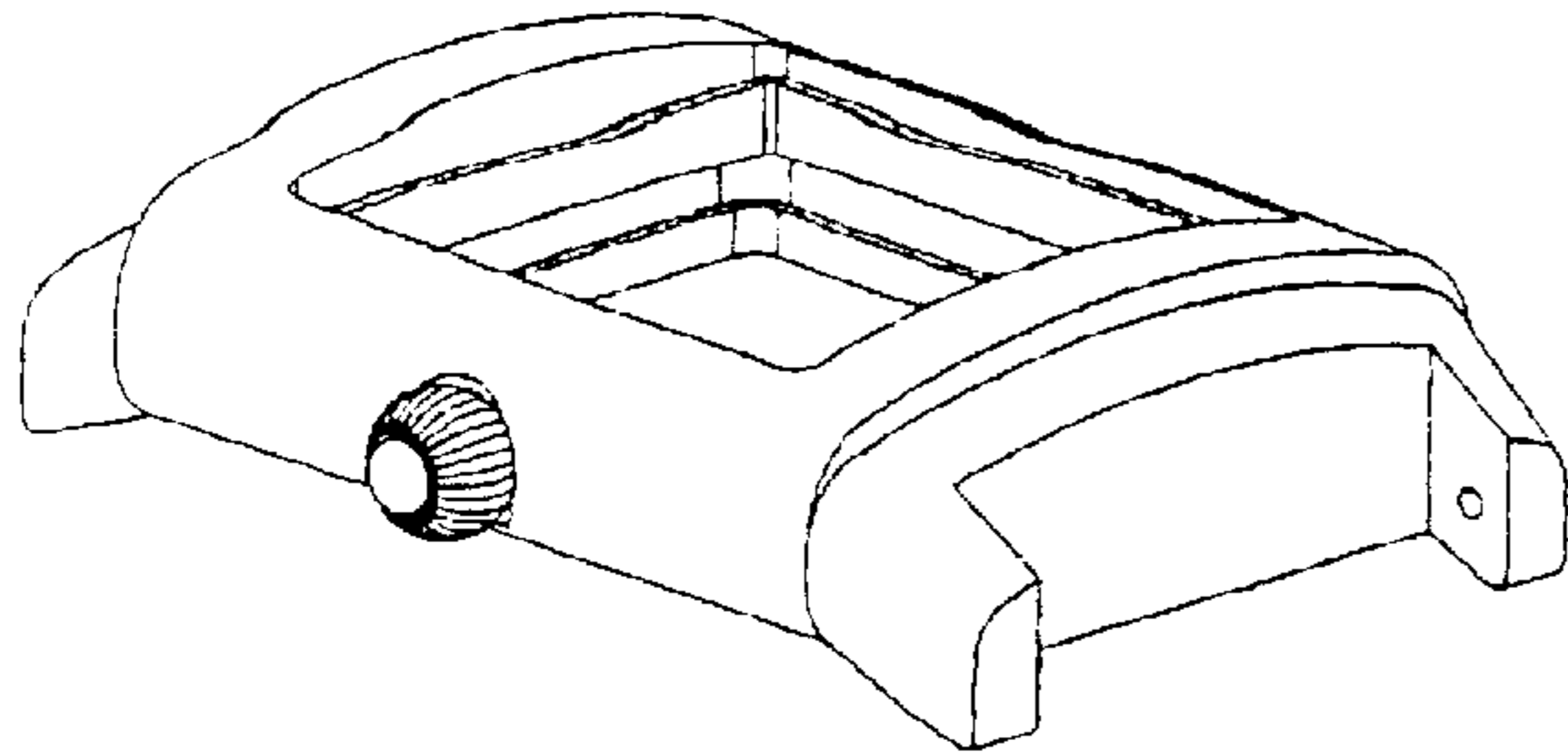

FIG. 1

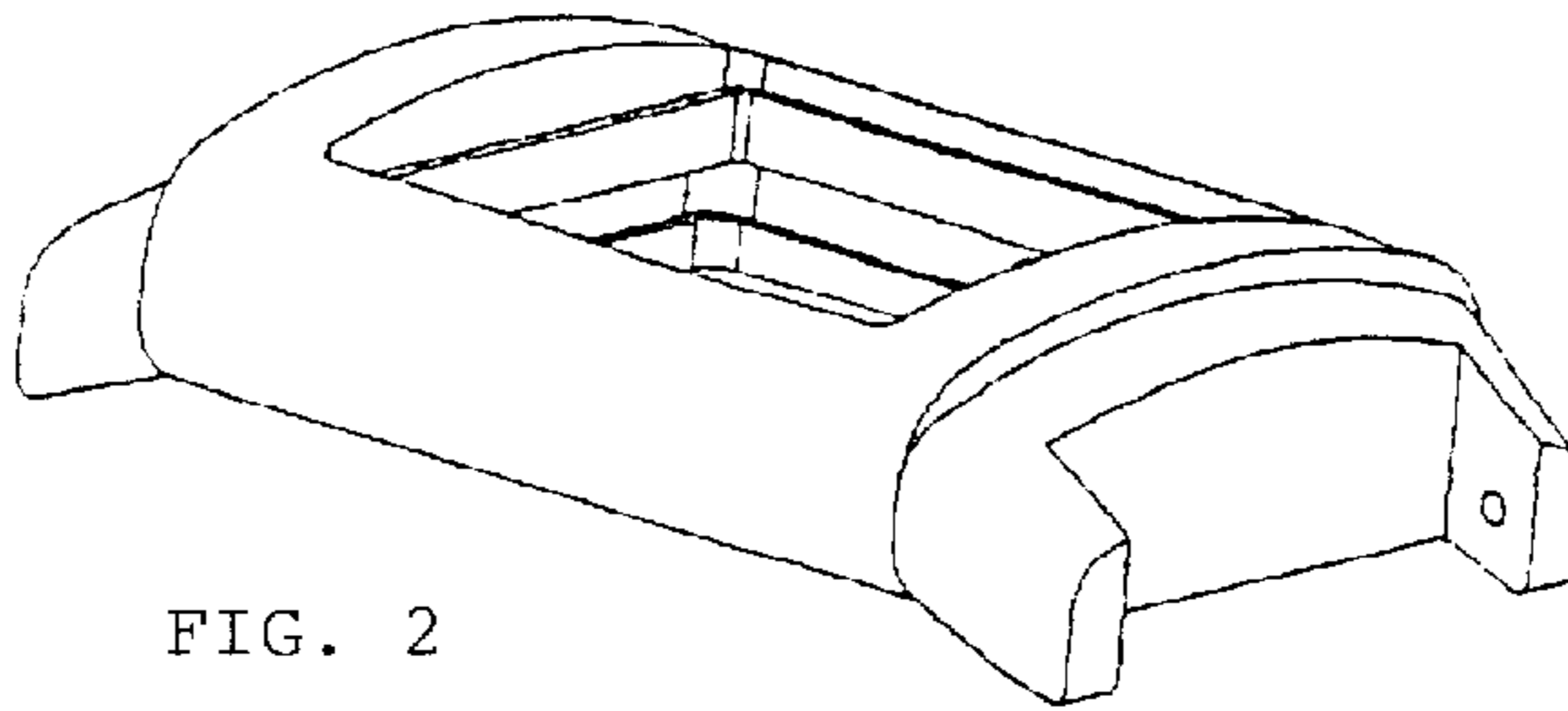

FIG. 2

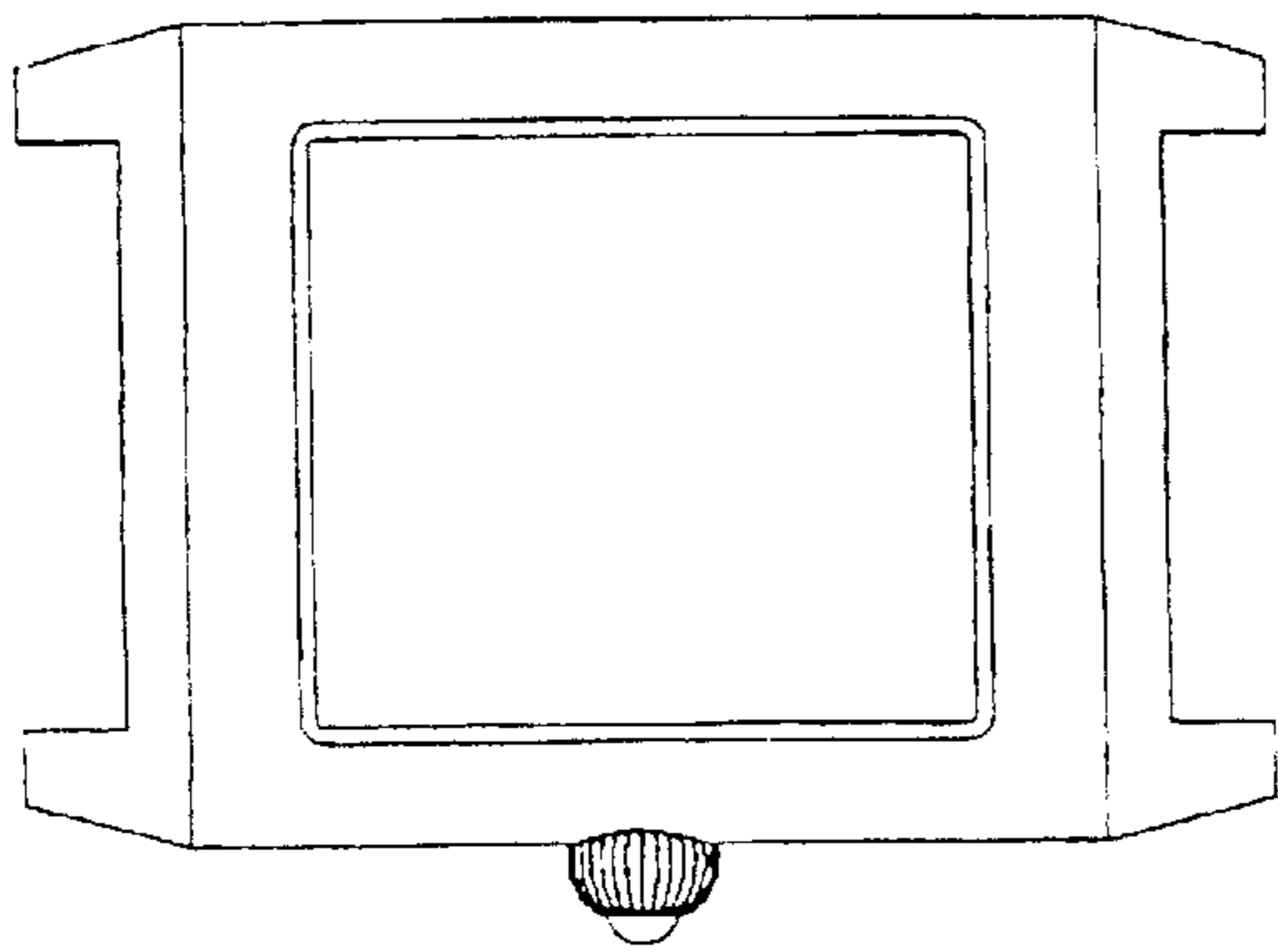

FIG. 3

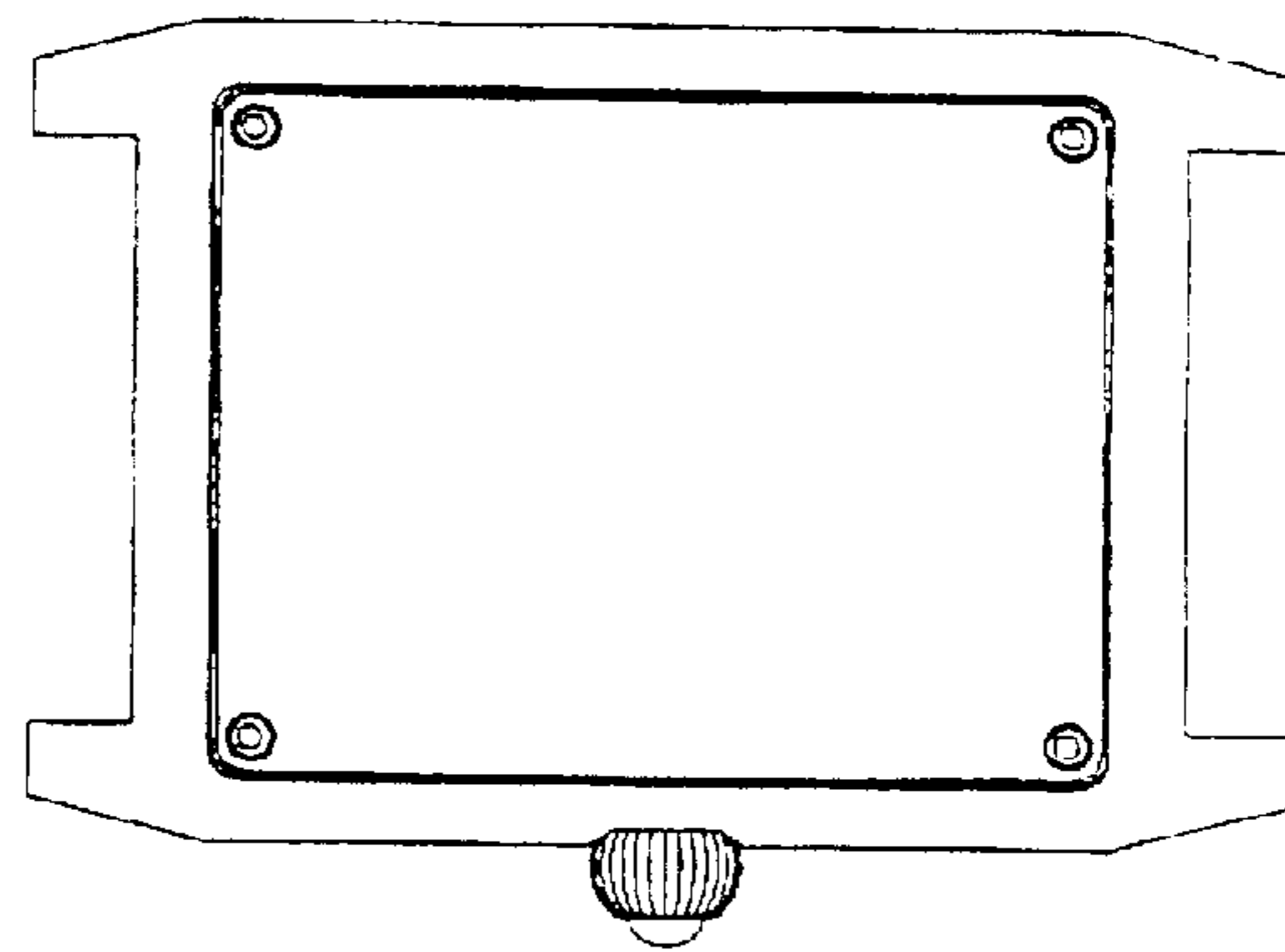

FIG. 4

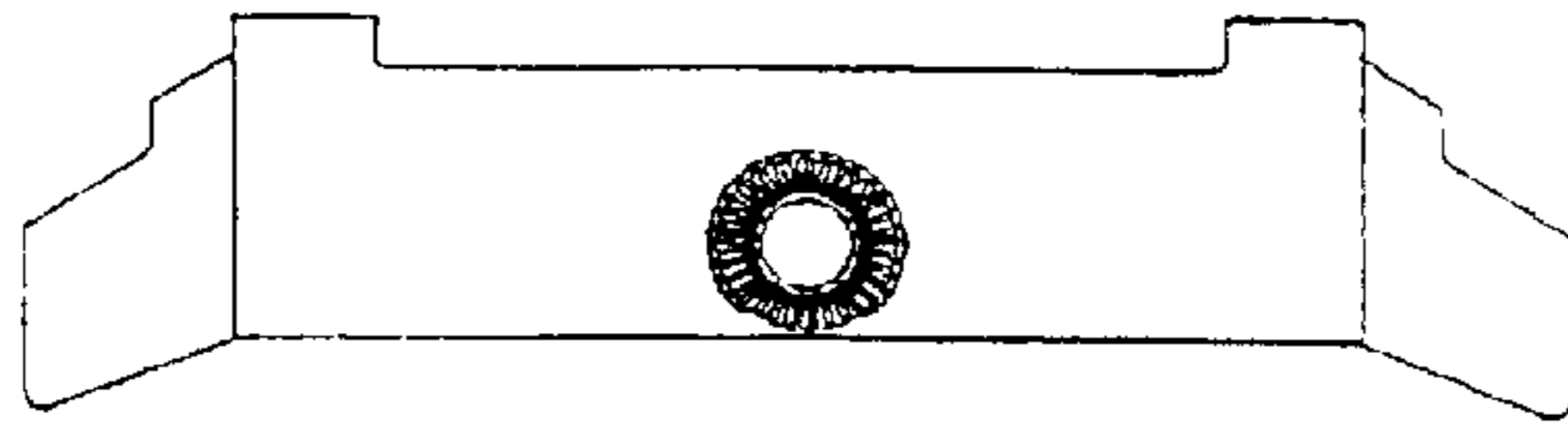

FIG. 5

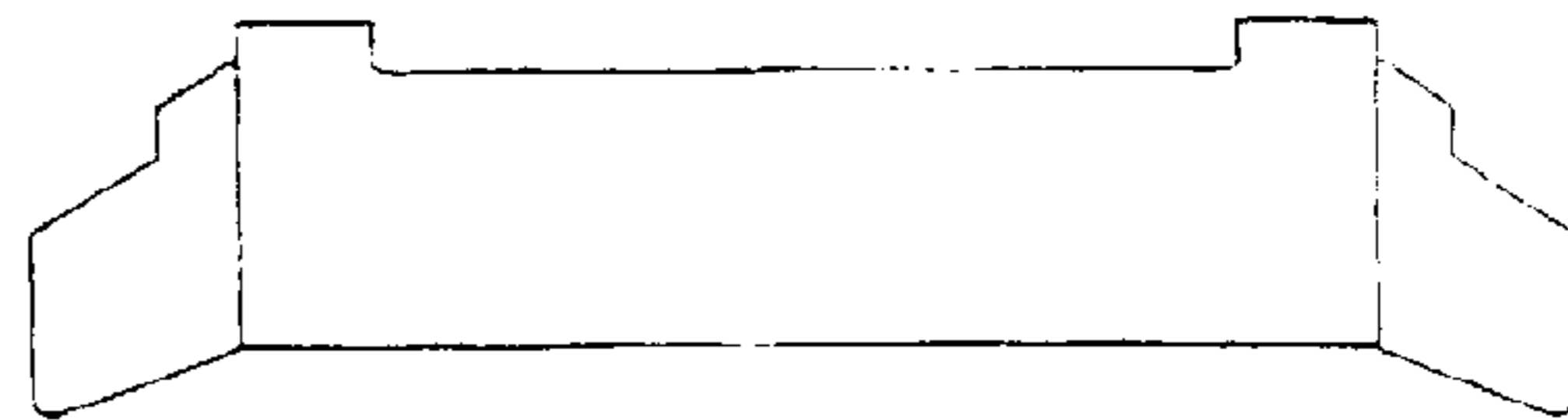

FIG. 6

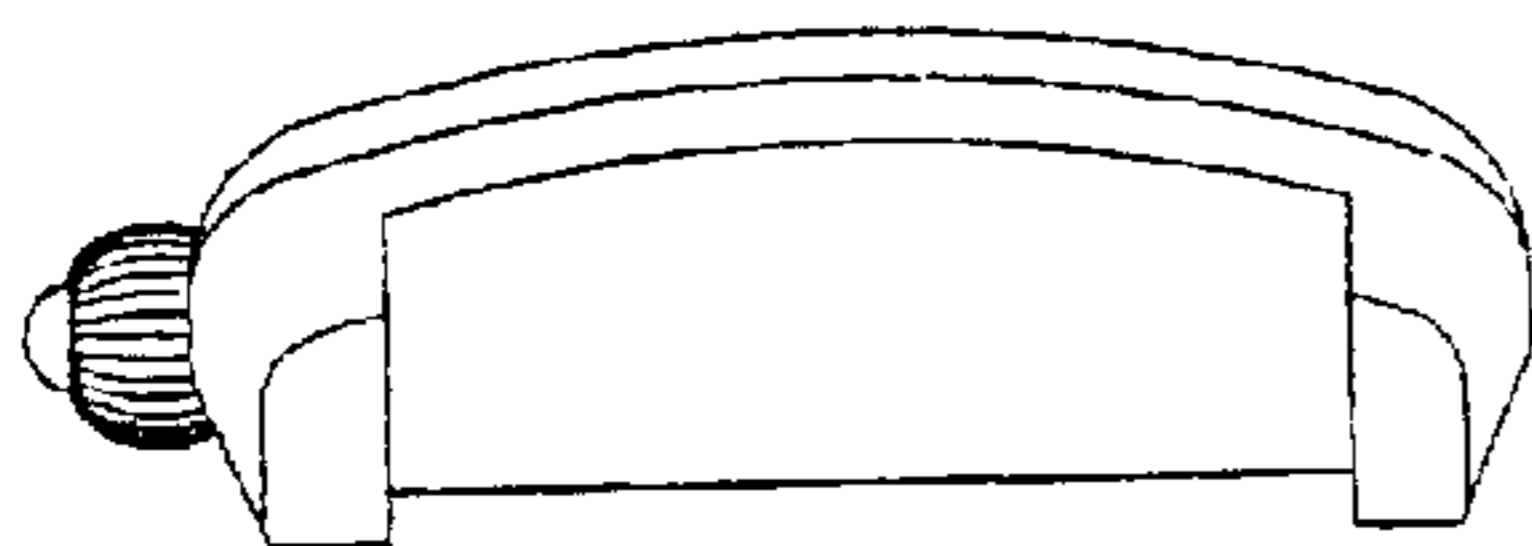

FIG. 7

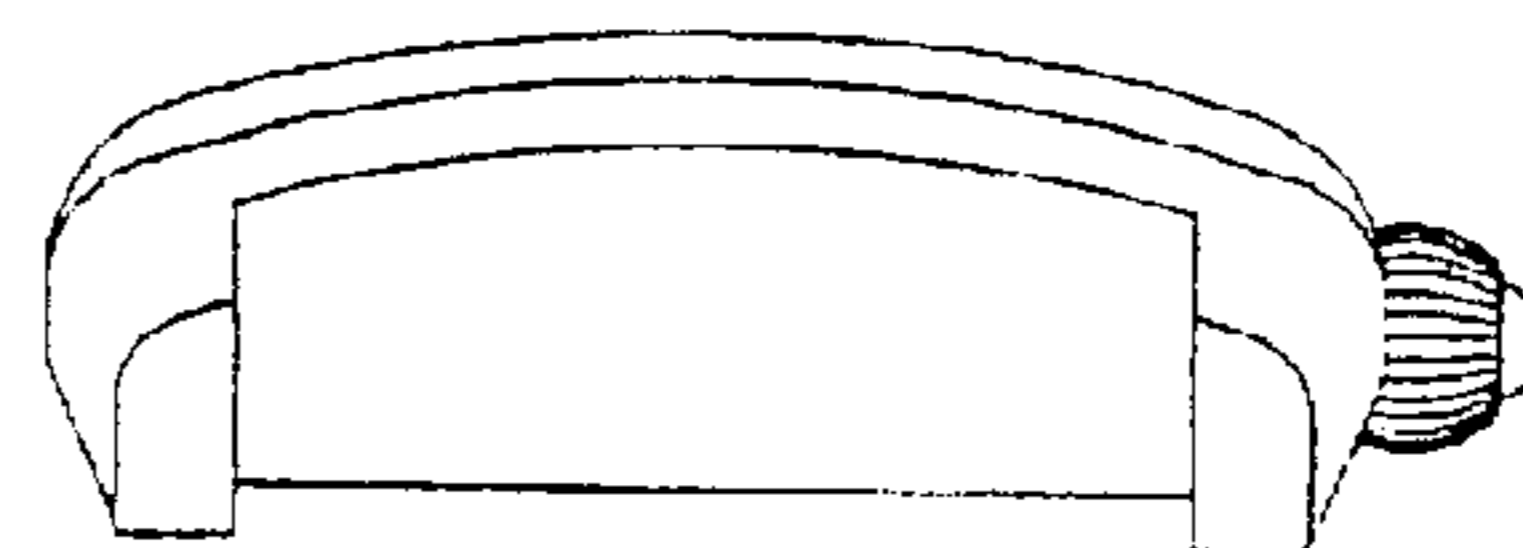

FIG. 8