

US00D507460S

(12) **United States Design Patent**  
**Omdoll et al.**

(10) **Patent No.:** **US D507,460 S**  
(45) **Date of Patent:** **\*\* Jul. 19, 2005**

(54) **CONDIMENT DISPENSER**

(75) Inventors: **Paul Omdoll**, Waukesha, WI (US);  
**Jeffrey W. Spencer**, Leicester (GB);  
**Thomas P. Kasting**, Fort Wayne, IN  
(US); **David J. Pritchett**, Fort Wayne,  
IN (US); **Brian Law**, Leicester (GB);  
**Tim Strandell**, Racine, WI (US); **Mike**  
**Phillips**, Milwaukee, WI (US); **Mark**  
**Brenneman**, Burlington, WI (US)

(73) Assignee: **The Colman Group, Inc.**, Elkhorn, WI  
(US)

(\*\*) Term: **14 Years**

(21) Appl. No.: **29/190,371**

(22) Filed: **Sep. 19, 2003**

(51) **LOC (8) Cl.** ..... **07-06**

(52) **U.S. Cl.** ..... **D7/590; D23/239**

(58) **Field of Search** ..... D7/590, 401.1,  
D7/397, 398; D9/447, 448; D23/238, 239,  
243, 245, 255; 22/180, 325, 372, 380, 382,  
385, 383.1, 384-386

(56) **References Cited**

**U.S. PATENT DOCUMENTS**

5,226,566 A \* 7/1993 Brandenburg ..... 222/180  
D367,918 S \* 3/1996 Haug et al. .... D23/238

5,579,959 A \* 12/1996 Bennett et al. .... 222/385  
D401,477 S \* 11/1998 Martindale ..... D7/590  
6,142,342 A \* 11/2000 Lewis ..... 222/180  
D470,925 S \* 2/2003 Blomstrom ..... D23/255  
D481,104 S \* 10/2003 Wettstein et al. .... D23/238

**OTHER PUBLICATIONS**

Condiment Units Server Express System brochure; Server  
Products, Inc.

Condiment Units/Topping Equip. Server Solution Pumps  
brochure; Server Products, Inc.

\* cited by examiner

*Primary Examiner*—Terry A. Wallace

(74) *Attorney, Agent, or Firm*—Brian G. Gilpin; Godfrey &  
Kahn, S.C.

(57) **CLAIM**

The ornamental design for a condiment dispenser, as shown.

**DESCRIPTION**

FIG. 1 is a perspective view of a condiment dispenser  
showing our new design;  
FIG. 2 is a bottom plan view thereof;  
FIG. 3 is a top plan view thereof;  
FIG. 4 is a front view thereof;  
FIG. 5 is a rear view thereof;  
FIG. 6 is a perspective view thereof; and,  
FIG. 7 is a perspective view thereof.

**1 Claim, 3 Drawing Sheets**

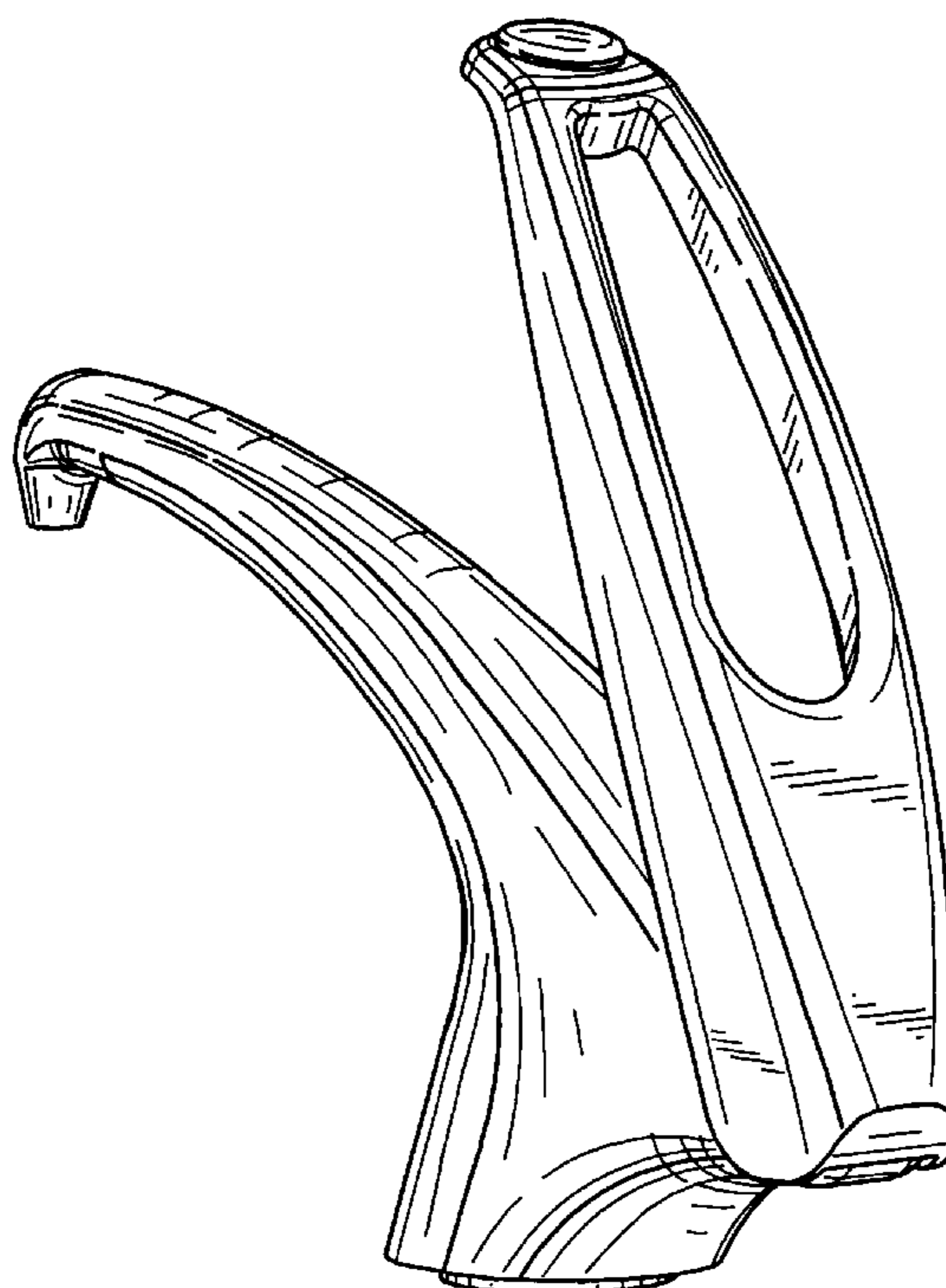

FIG. 1

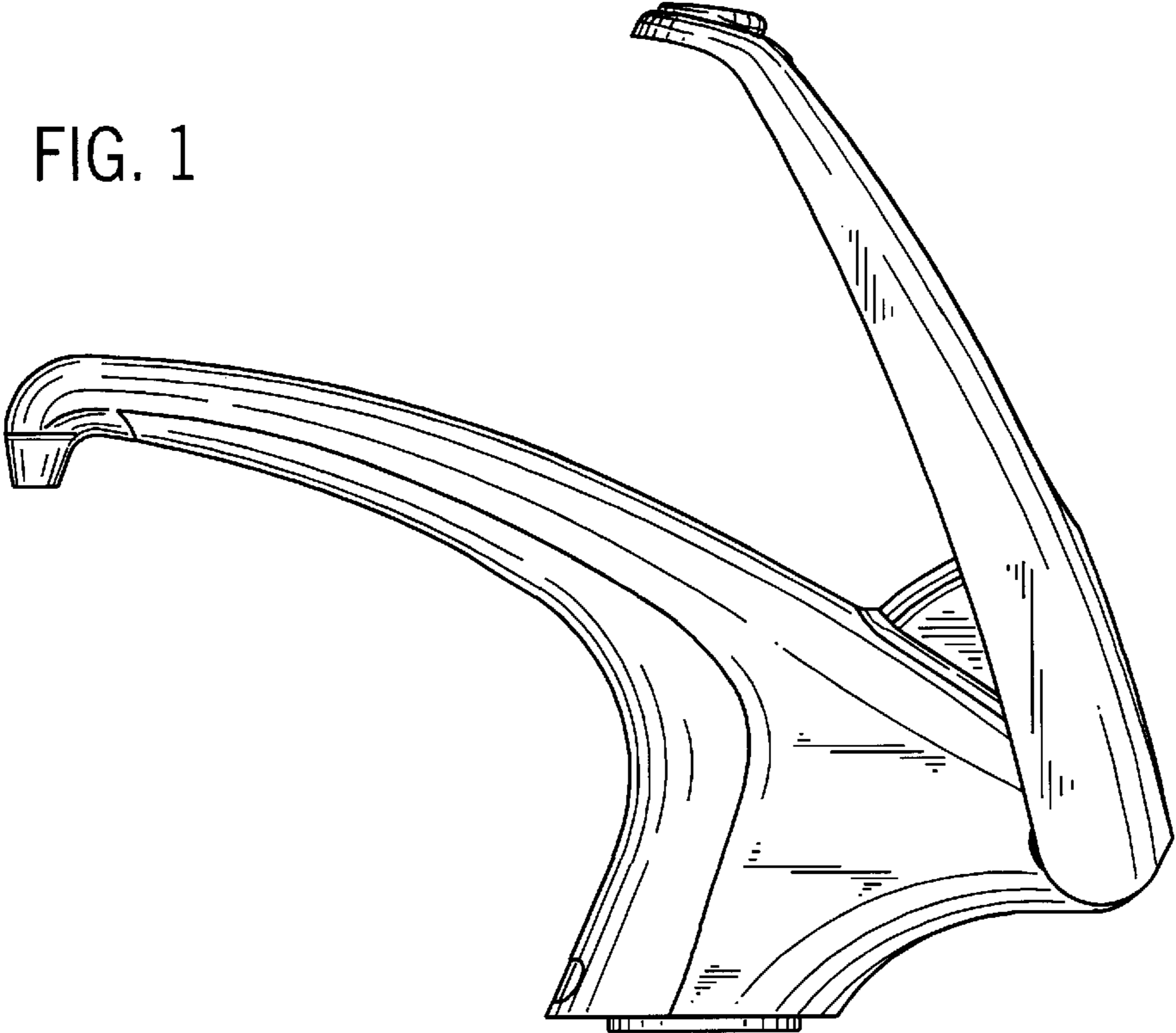

FIG. 2

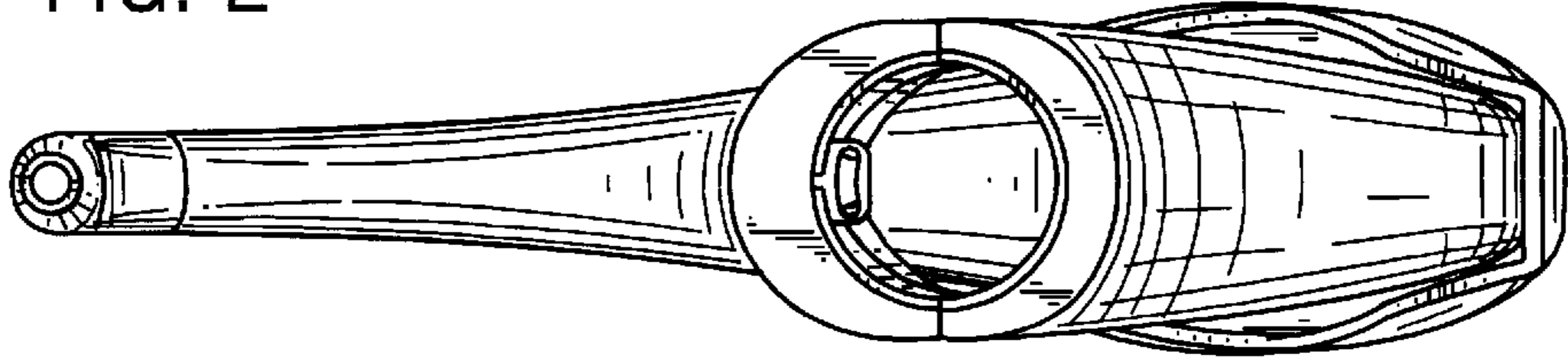
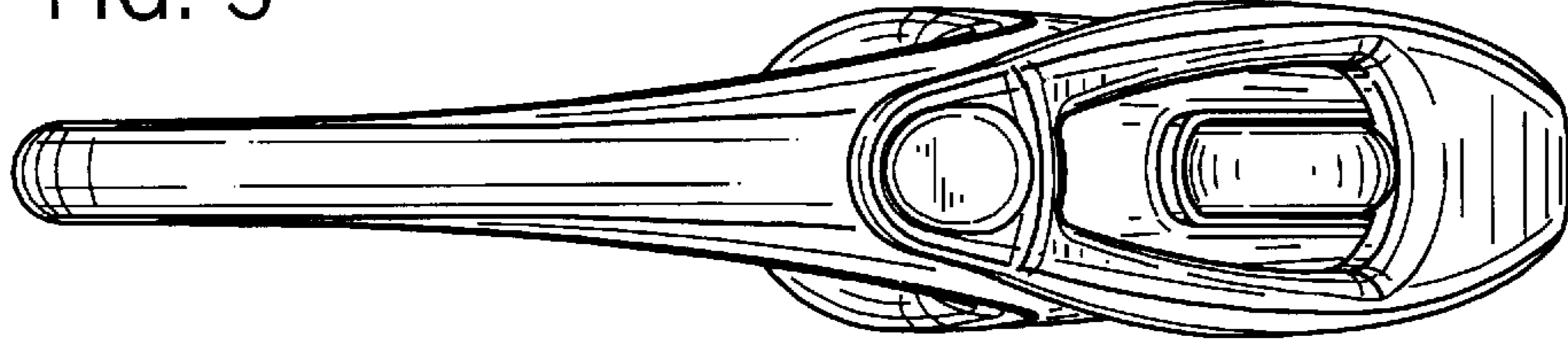

FIG. 3



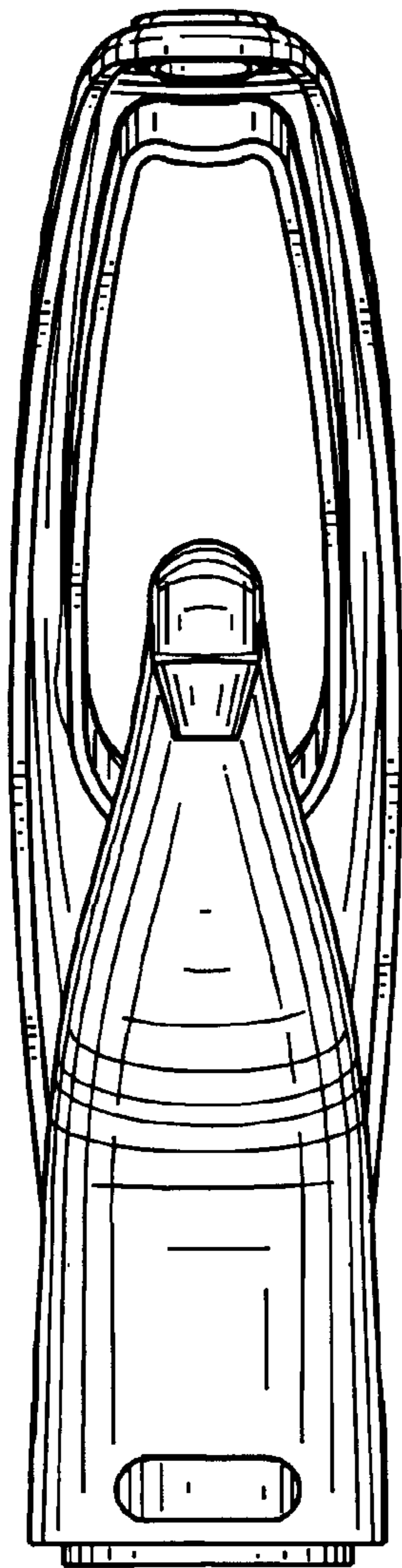

FIG. 4

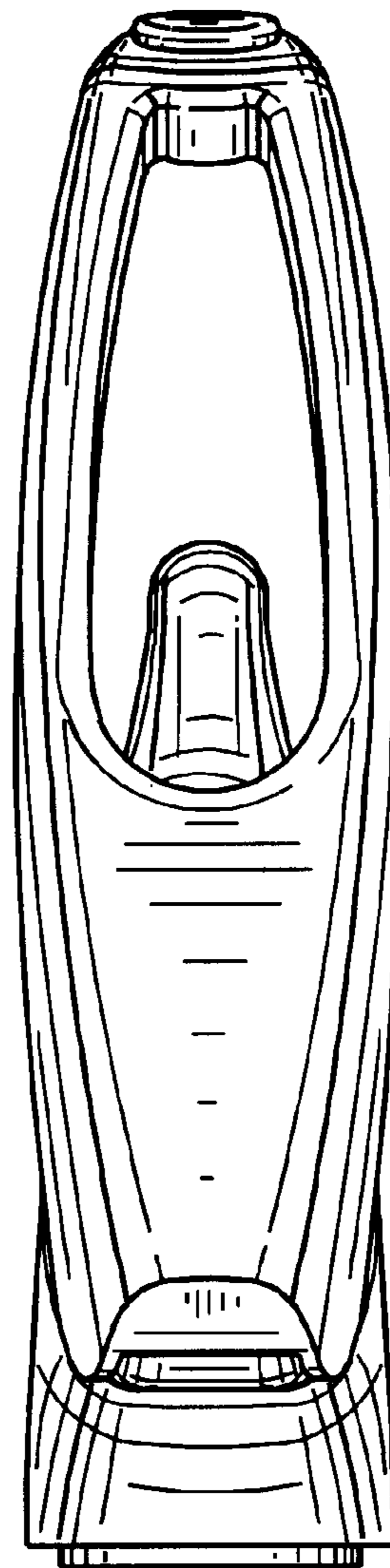

FIG. 5

FIG. 6

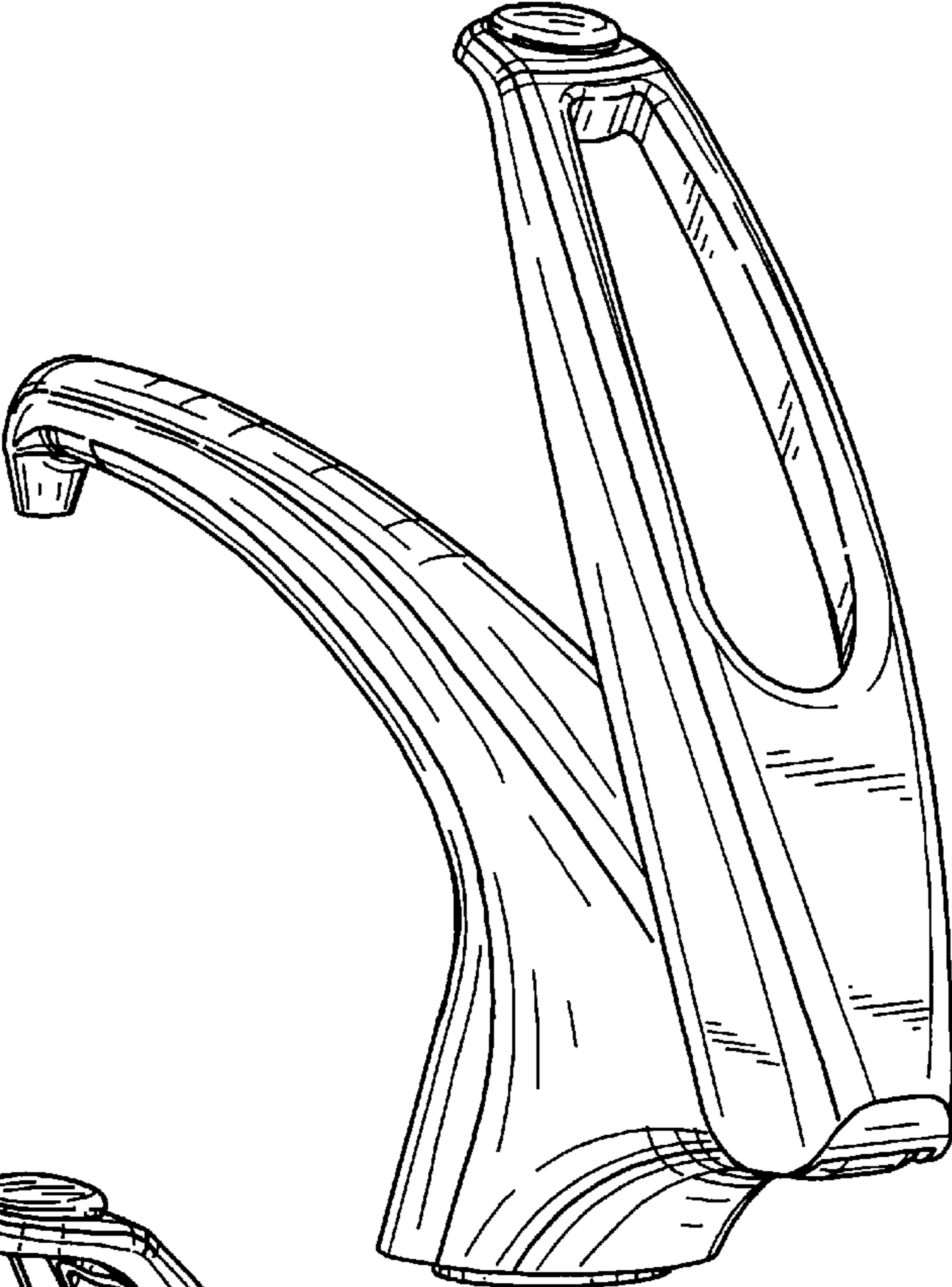

FIG. 7

