

US00D507443S

(12) **United States Design Patent** (10) **Patent No.:** **US D507,443 S**
Gilbert (45) **Date of Patent:** **** Jul. 19, 2005**

(54) **ACCESSORY POST** D455,593 S 4/2002 Hoernig
D461,353 S 8/2002 Gilbert
(75) **Inventor:** **Christopher Jon Gilbert**, Moreland Hills, OH (US) D463,699 S 10/2002 Gilbert
D472,059 S 3/2003 Hoernig
D472,061 S 3/2003 Hoernig
(73) **Assignee:** **Moen Incorporated**, North Olmsted, OH (US) D477,485 S 7/2003 Hoernig
D481,235 S * 10/2003 Gilbert D6/524
D492,523 S * 7/2004 Graves et al. D6/524
(**) **Term:** **14 Years** * cited by examiner

(21) **Appl. No.:** **29/198,252**

(22) **Filed:** **Jan. 27, 2004**

(51) **LOC (8) Cl.** **23-02**

(52) **U.S. Cl.** **D6/524**

(58) **Field of Search** D6/546-550, 518-519,
D6/522-524; D8/300, 303, 315-321, 354,
363, 373, 380; 108/28-29; 211/13.1, 16,
60.1, 86.01, 87.01, 88.01, 88.04, 100, 105.1-105.2,
123, 126.1, 133.6, 134, 181.1, 182; 248/175,
176.1, 200, 251, 302, 309.1; 16/110.1,
412, 415; 242/570, 590, 595-598; 206/389,
557

(56) **References Cited**

U.S. PATENT DOCUMENTS

D155,168 S * 9/1949 Kiehl D6/550
D375,011 S * 10/1996 Lee D6/550
D432,832 S 10/2000 Gastelum et al.
D432,842 S 10/2000 Gastelum et al.
D434,259 S 11/2000 Gastelum et al.
D436,453 S 1/2001 Gastelum et al.
D437,157 S 2/2001 Gastelum et al.
D451,738 S * 12/2001 Yeh D6/550
D453,438 S 2/2002 Hoernig
D455,309 S * 4/2002 Hoernig D6/550

Primary Examiner—Brian N Vinson
(74) *Attorney, Agent, or Firm*—Calfee, Halter & Griswold, LLP

(57) **CLAIM**

The ornamental design for an accessory post, as shown and described.

DESCRIPTION

FIG. 1 is a perspective view of an accessory post of the new design;
FIG. 2 is a top plan view of the accessory post of FIG. 1;
FIG. 3 is a right side elevational view of the accessory post of FIG. 1;
FIG. 4 is a front elevational view of the accessory post of FIG. 1;
FIG. 5 is a bottom plan view of the accessory post of FIG. 1; and
FIG. 6 is a left side elevational view of the accessory post of FIG. 1; and,
FIG. 7 is a rear elevational view of the accessory post of FIG. 1.
The broken-line disclosure in the views is for illustrative purposes only, and forms no part of the claimed design.

1 Claim, 2 Drawing Sheets

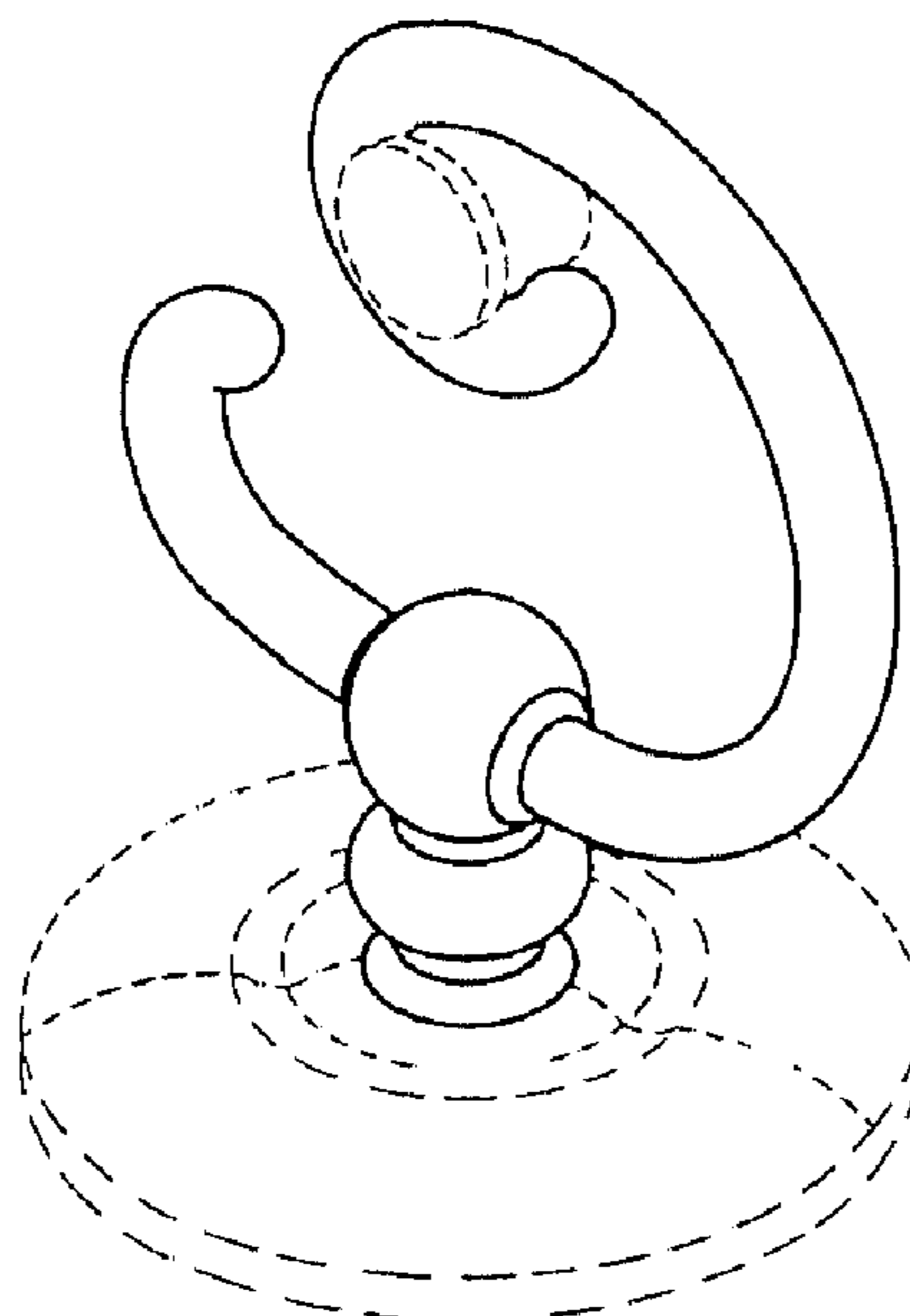

Fig. 1

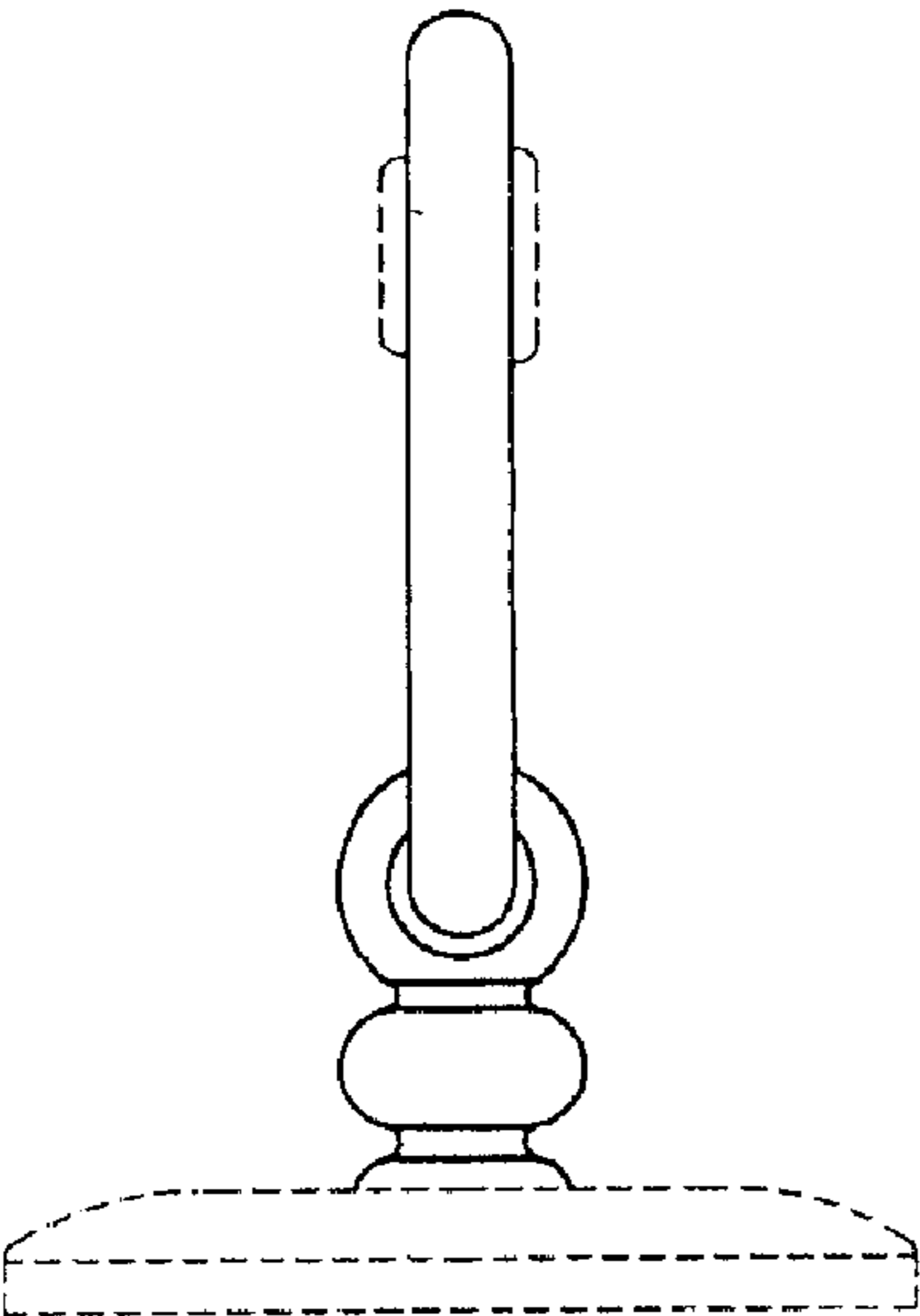
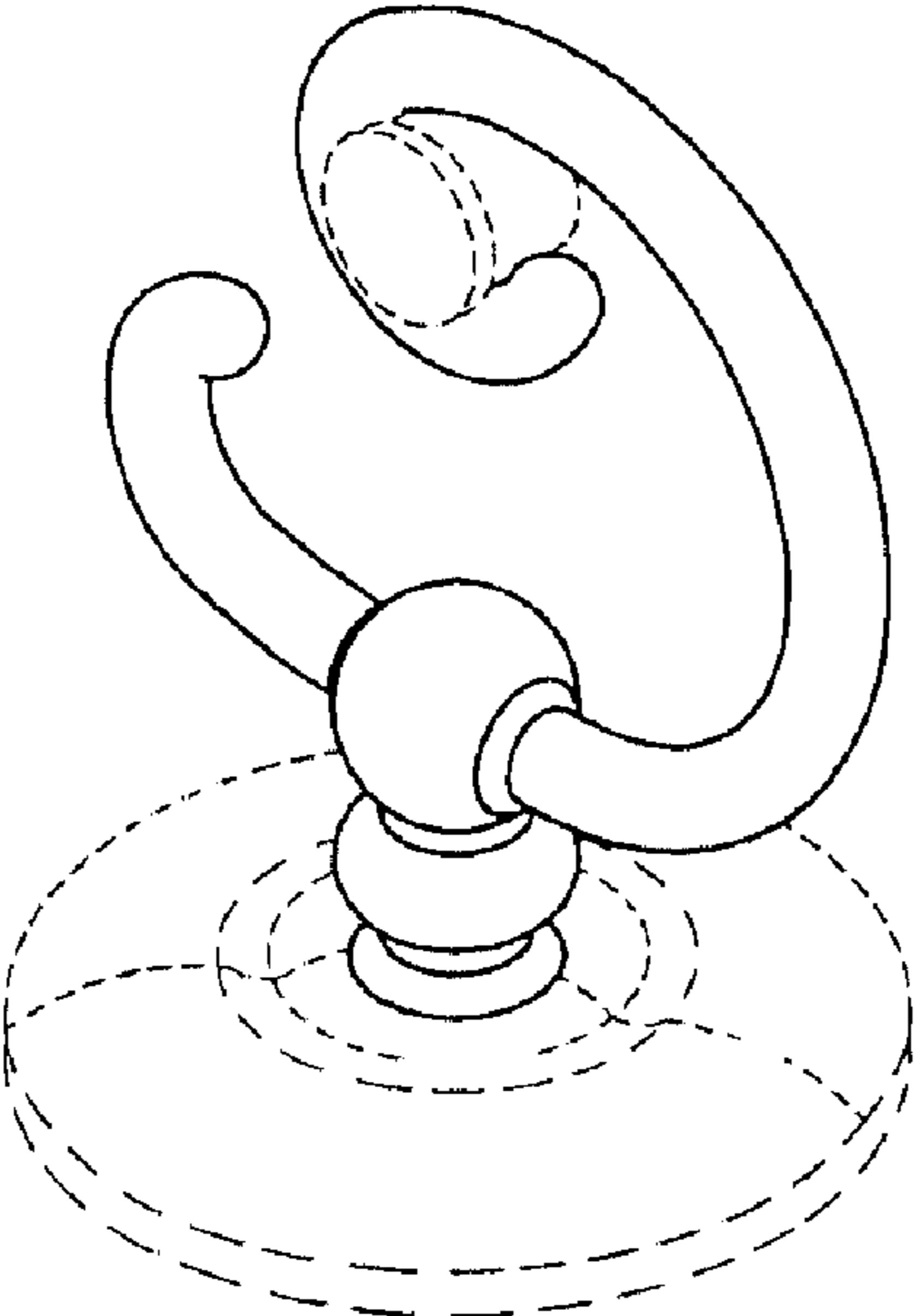

Fig. 2

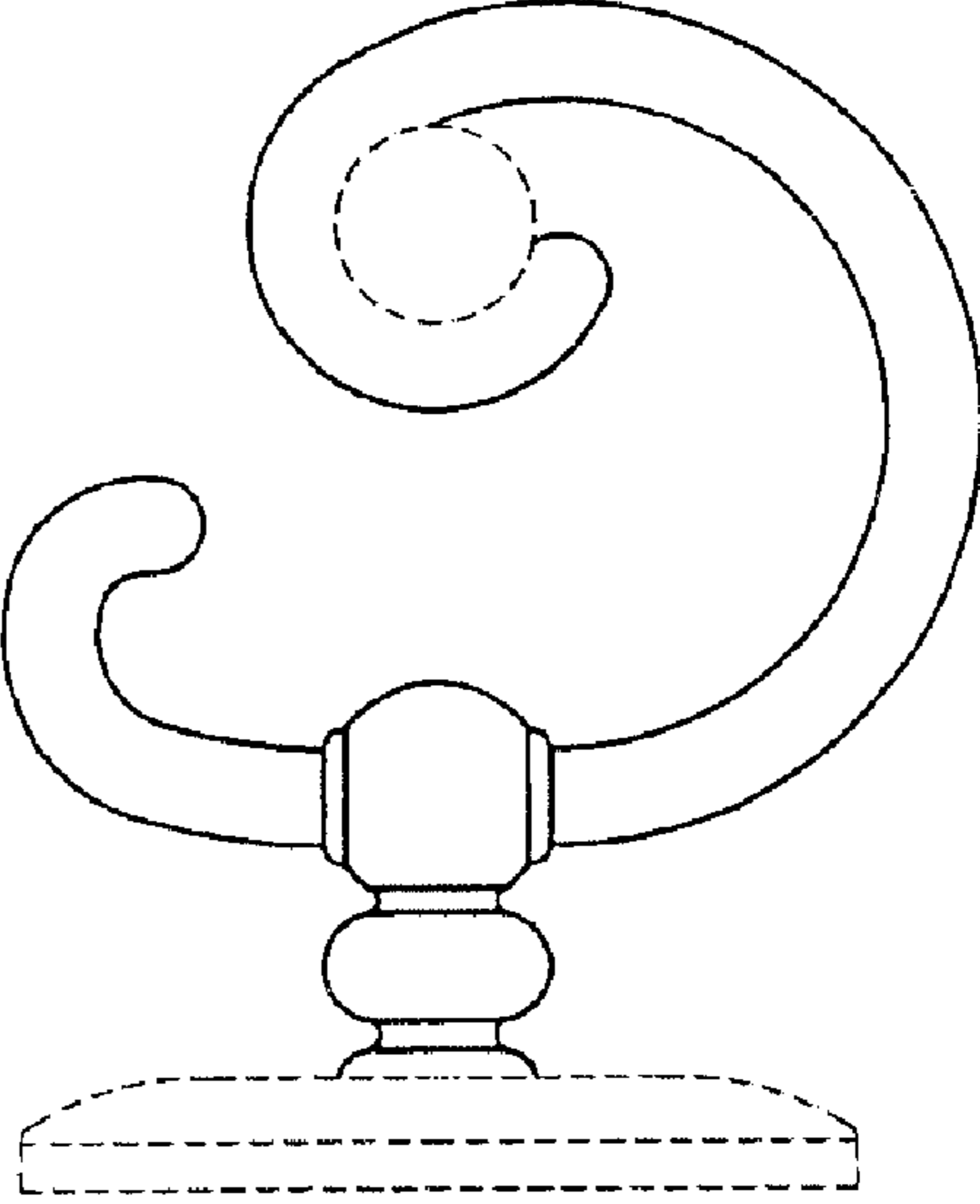

Fig. 3

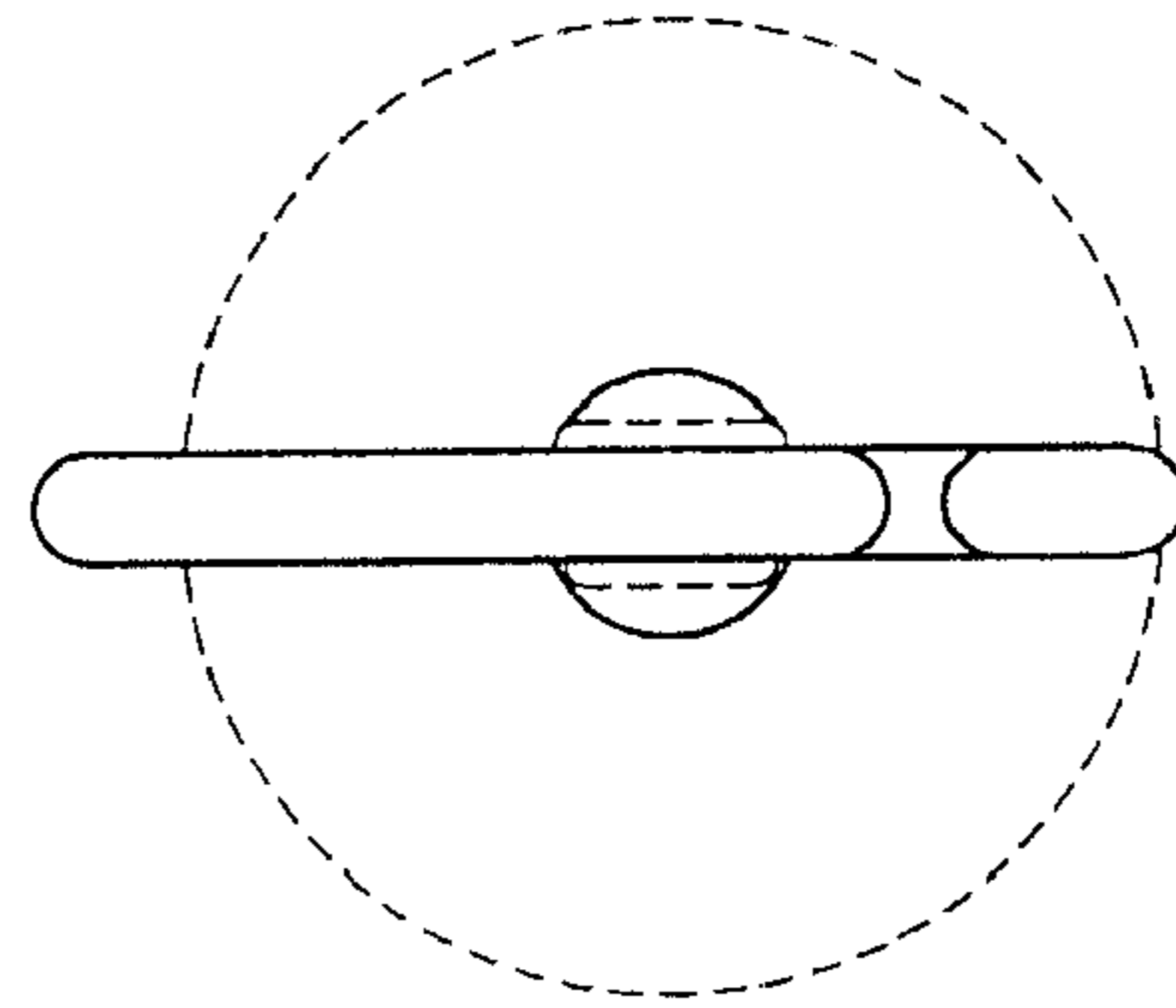

Fig. 4

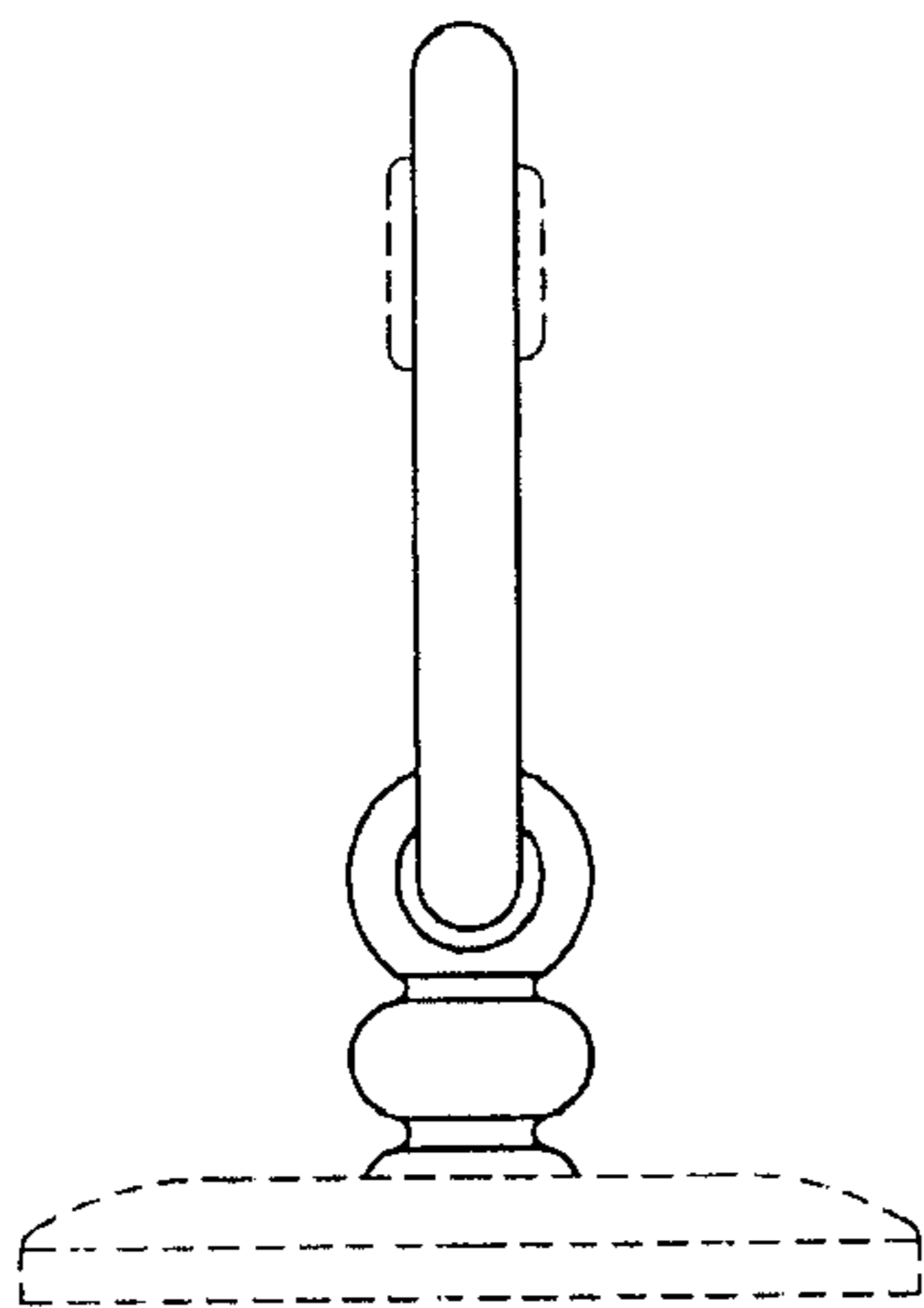

Fig. 5

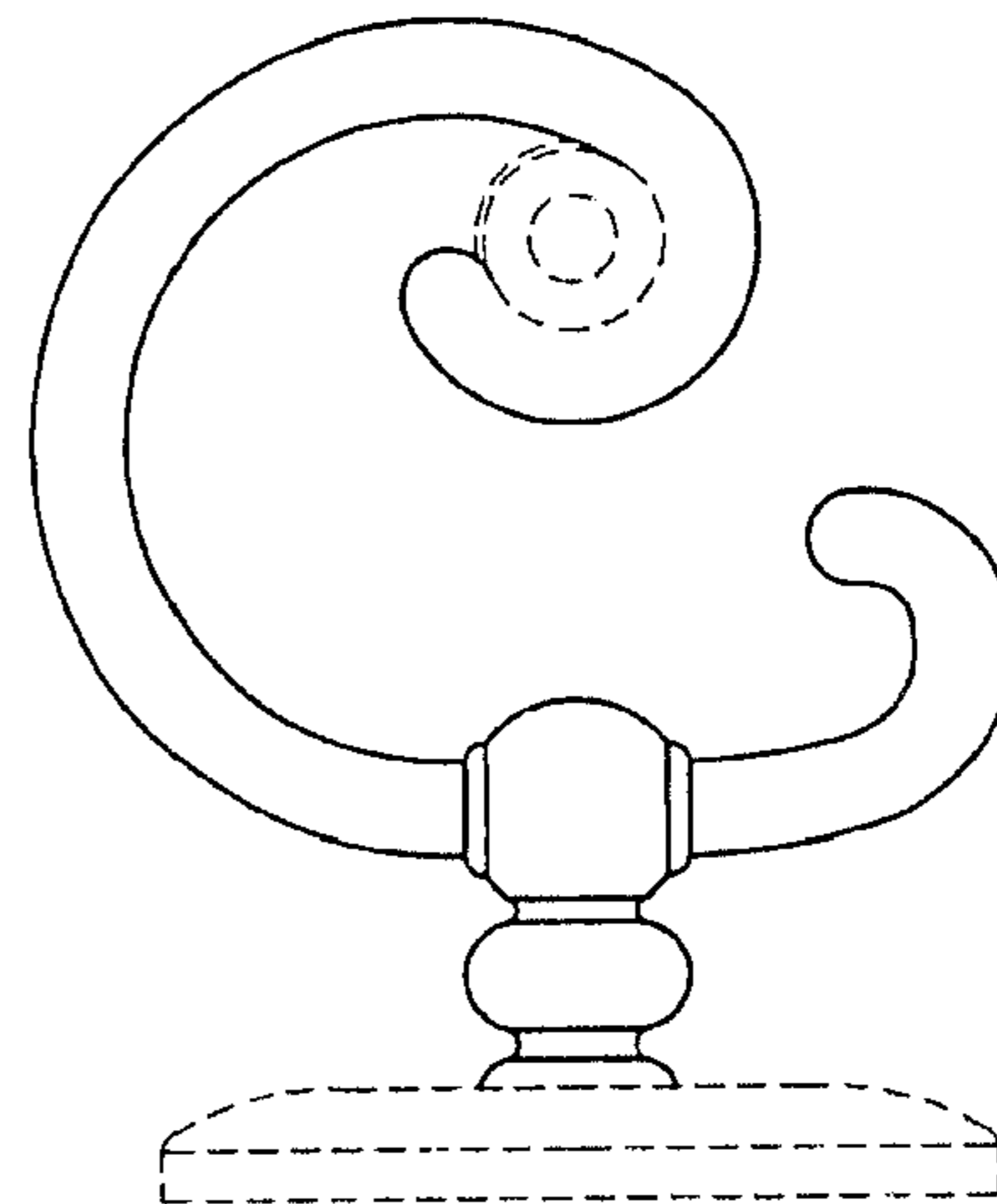

Fig. 6

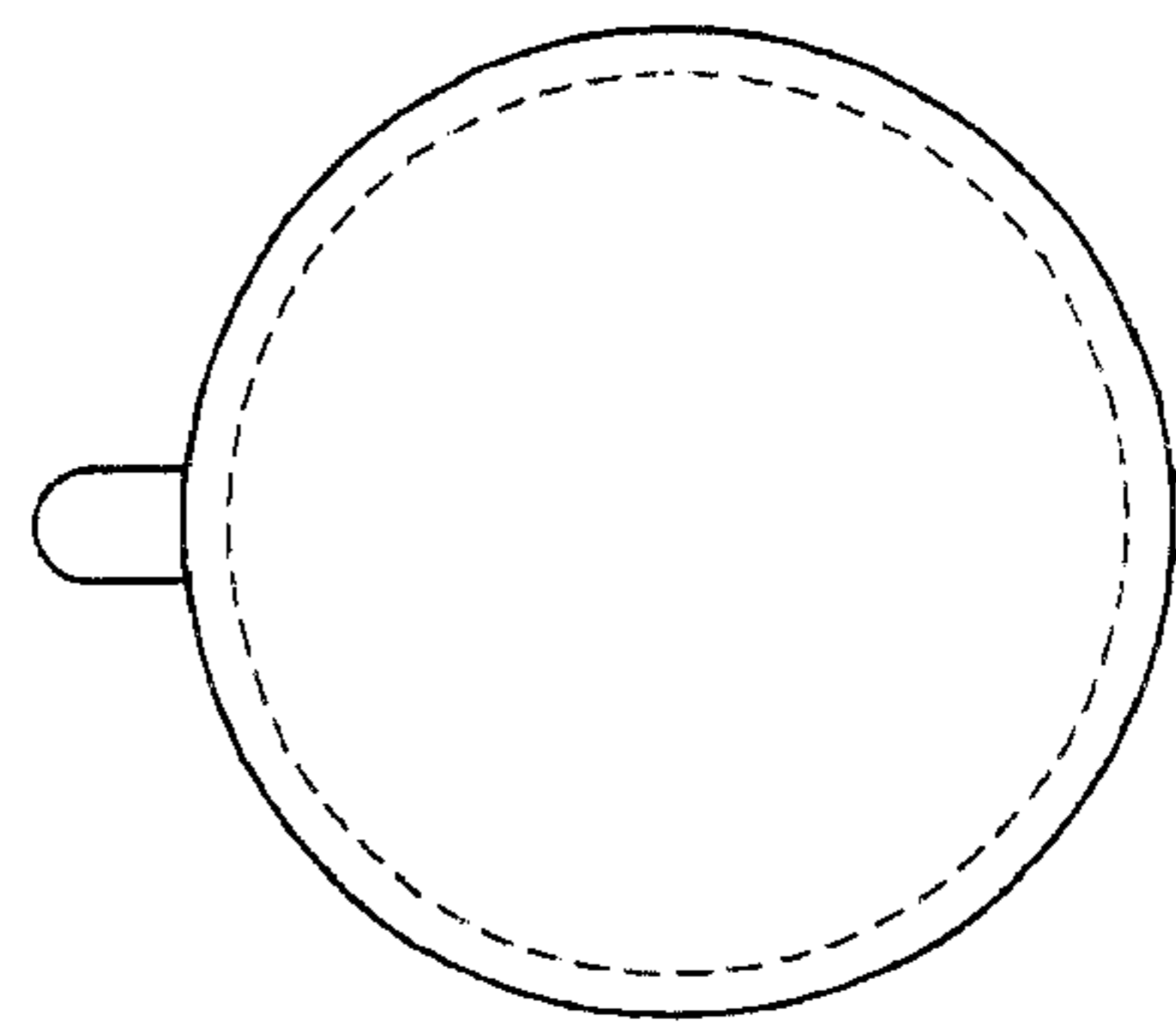

Fig. 7