

US00D507434S

(12) **United States Design Patent**
Mohundro

(10) **Patent No.:** **US D507,434 S**

(45) **Date of Patent:** **** Jul. 19, 2005**

(54) **COCKTAIL TABLE**

D355,316 S * 2/1995 Kellen D6/484
D459,621 S * 7/2002 O'Hare et al. D6/484
D497,742 S * 11/2004 Dortch D6/480

(75) **Inventor:** **James Glenn Mohundro, Taichung (TW)**

* cited by examiner

(73) **Assignee:** **Pacific Marketing International (H.K.), Ltd., Taichung (TW)**

Primary Examiner—Janice E. Seeger
(74) *Attorney, Agent, or Firm*—Rosenberg, Klein & Lee

(**) **Term:** **14 Years**

(57) **CLAIM**

(21) **Appl. No.:** **29/203,527**

The ornamental design for a cocktail table, as shown and described.

(22) **Filed:** **Apr. 16, 2004**

DESCRIPTION

(51) **LOC (8) Cl.** **06-03**

(52) **U.S. Cl.** **D6/480**

(58) **Field of Search** D6/480-489, 495-499,
D6/349, 477; 248/188, 188.1, 188.8, 188.9;
108/153.1, 155, 156, 157.1, 161

FIG. 1 is a perspective view of a cocktail table, showing my new design;
FIG. 2 is a front elevational view thereof;
FIG. 3 is a rear elevational view thereof;
FIG. 4 is a left elevational view thereof;
FIG. 5 is a right elevational view thereof;
FIG. 6 is a top plan view thereof; and,
FIG. 7 is a bottom plan view thereof.

(56) **References Cited**

U.S. PATENT DOCUMENTS

D344,421 S * 2/1994 Keller D6/484

1 Claim, 5 Drawing Sheets

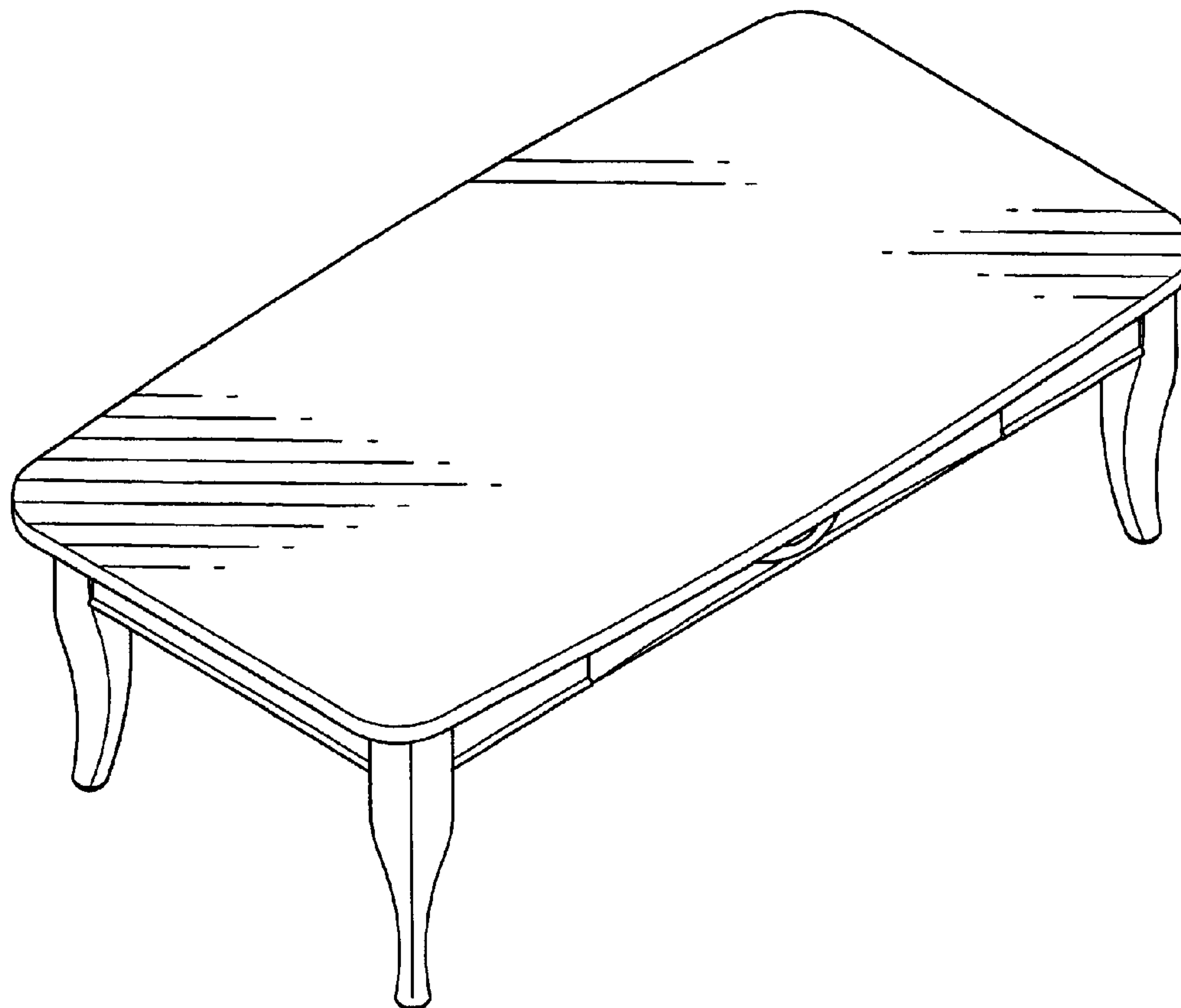

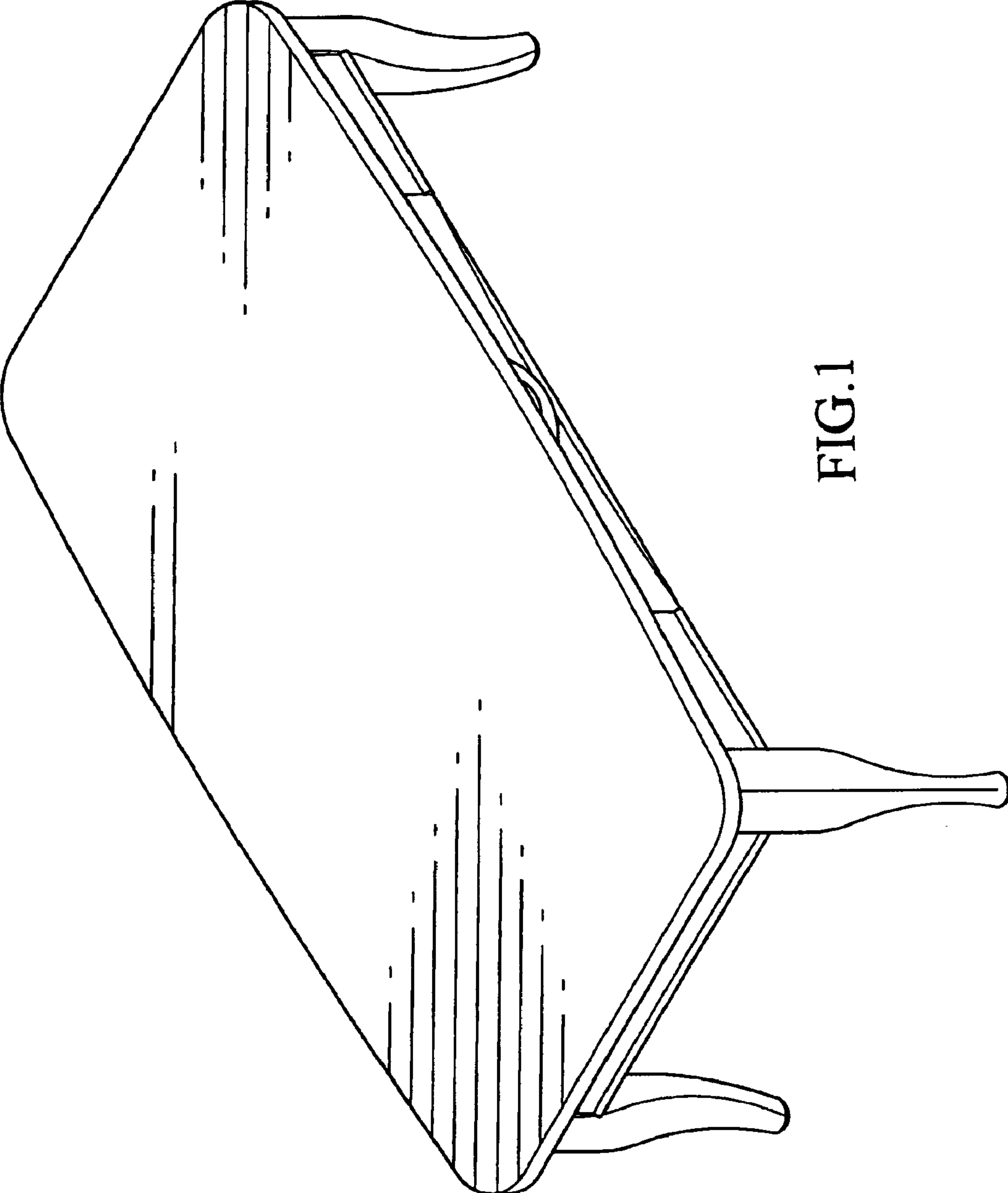
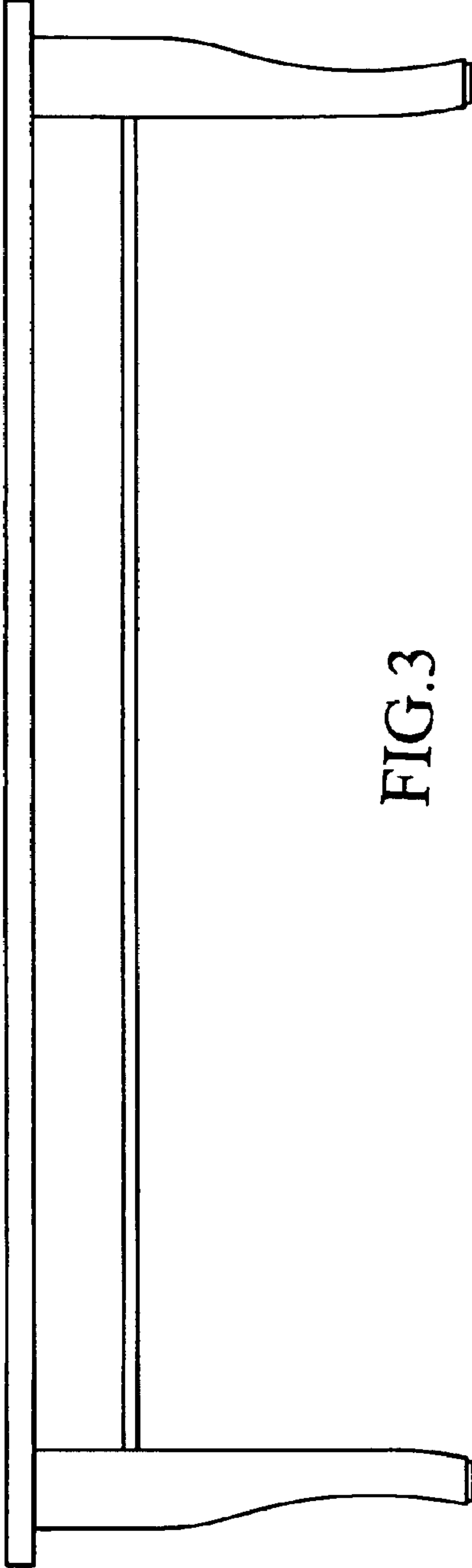
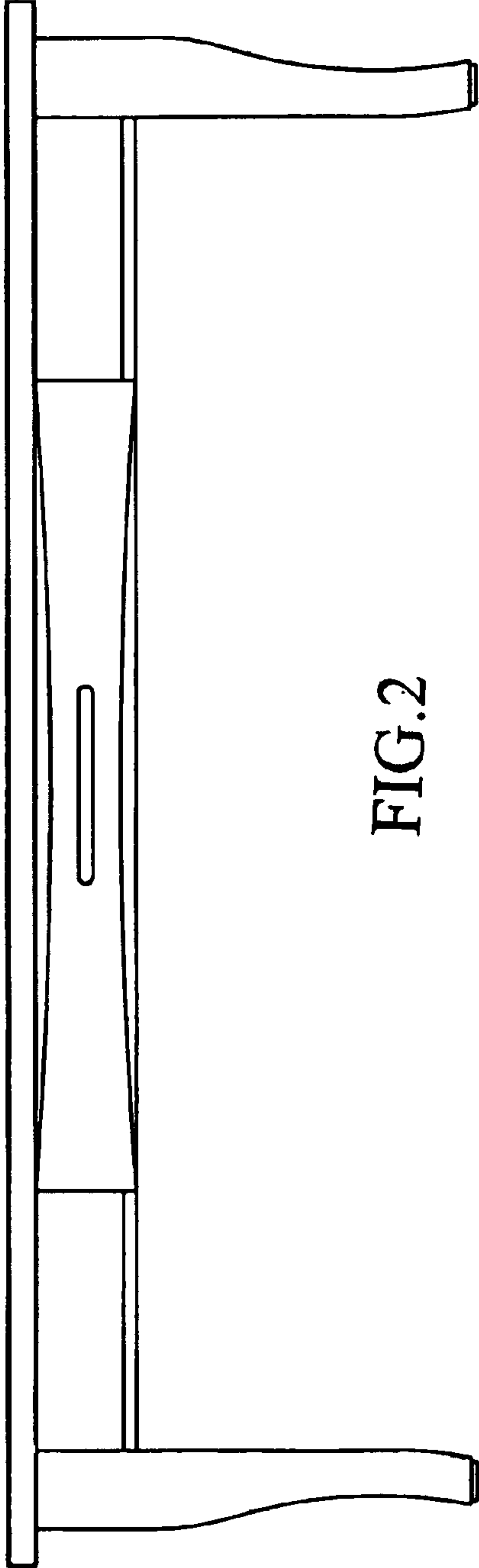

FIG.1



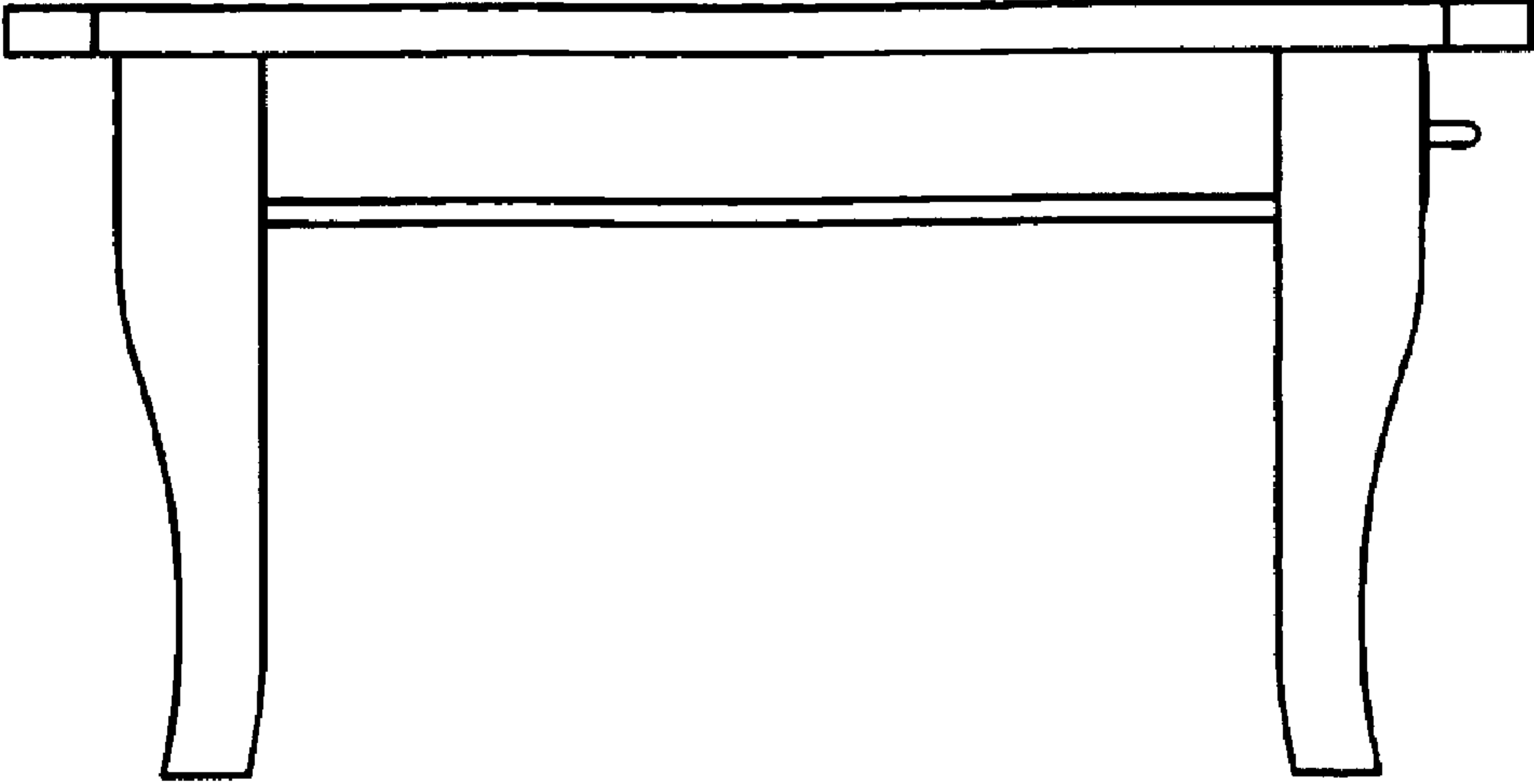

FIG. 4

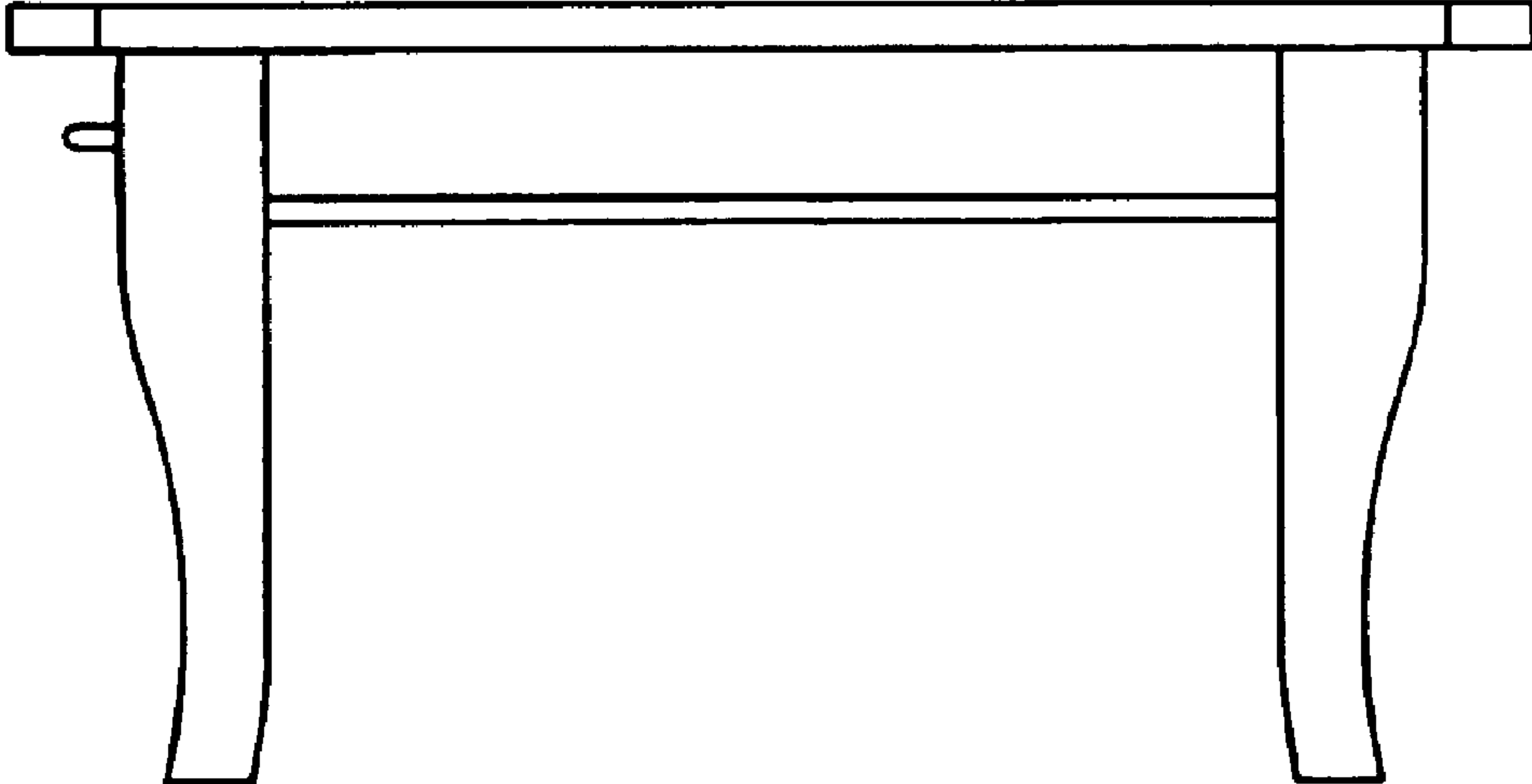

FIG. 5

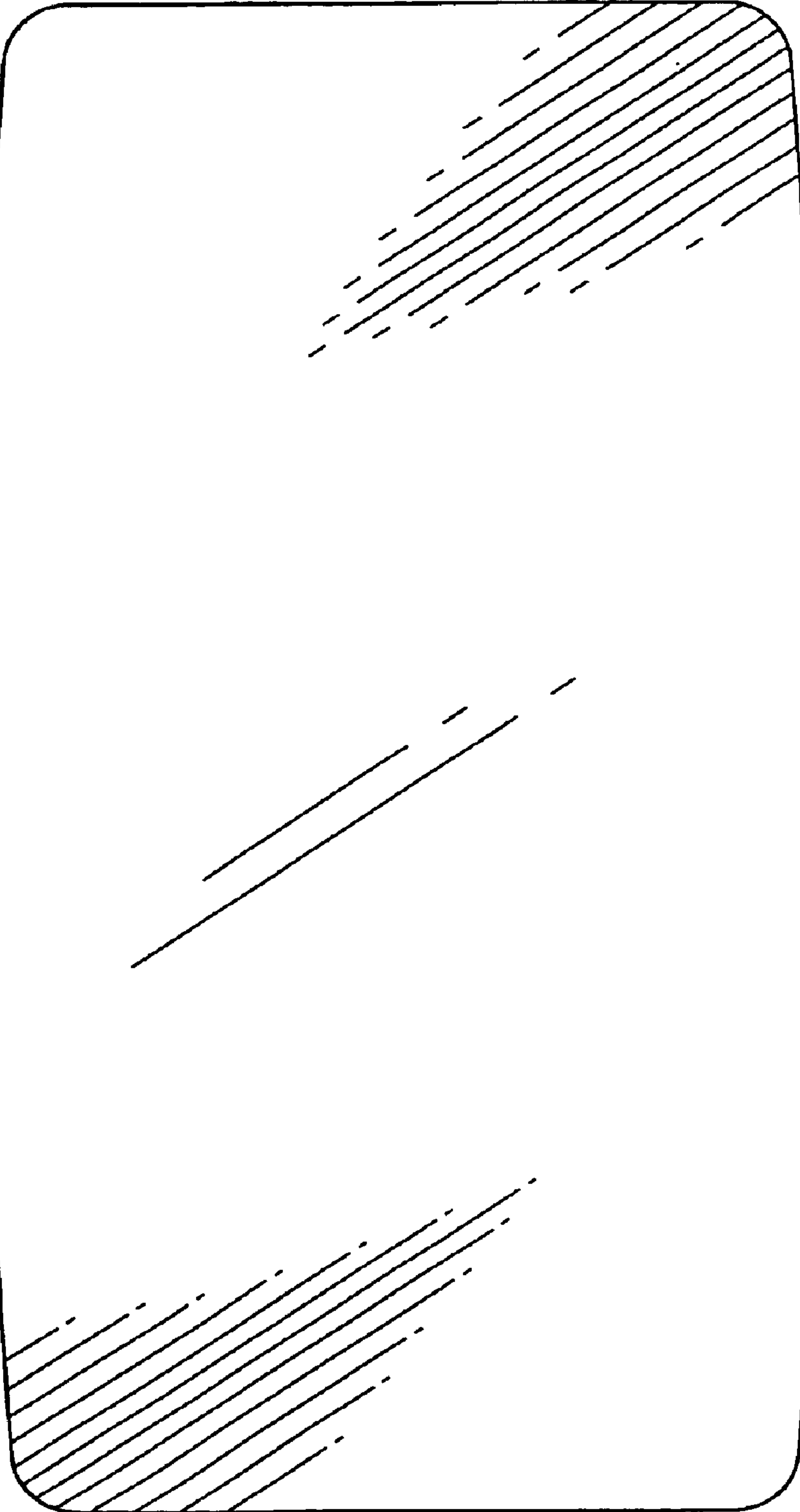

FIG.6

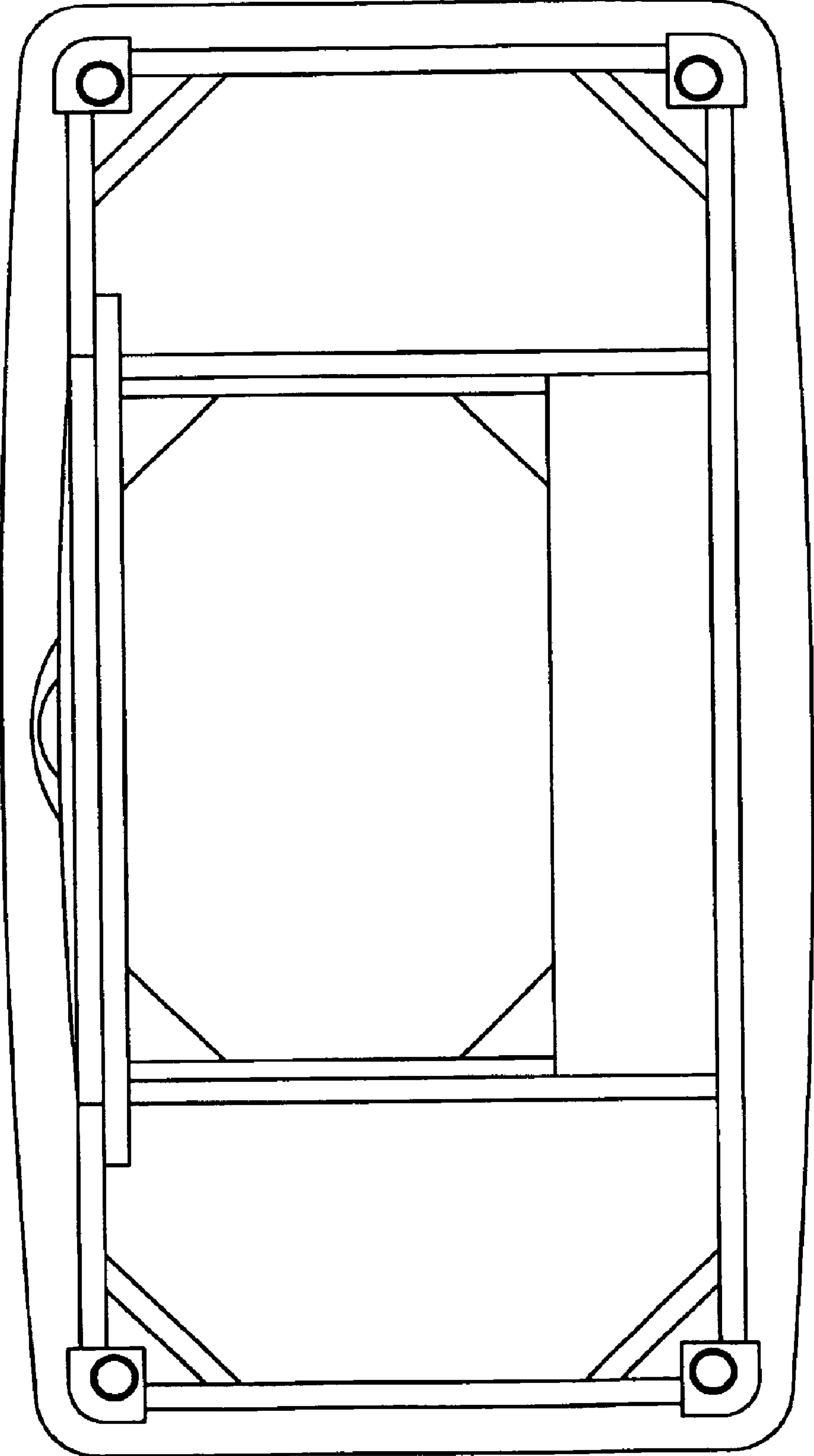

FIG.7