

US00D507305S

(12) **United States Design Patent**
Dill

(10) **Patent No.:** **US D507,305 S**
(45) **Date of Patent:** **** Jul. 12, 2005**

(54) **PAPER HOLDER**

(76) Inventor: **Etienne Dill**, 54 Boulevard
Beaumarchais, 75011 Paris (FR)

(**) Term: **14 Years**

(21) Appl. No.: **29/172,035**

(22) Filed: **Dec. 5, 2002**

(30) **Foreign Application Priority Data**

Jun. 5, 2002 (FR) 02 3492

(51) **LOC (8) Cl.** **19-02**

(52) **U.S. Cl.** **D19/90; D19/97; D19/95**

(58) **Field of Search** **D9/307; D19/35,**
D19/36, 65, 75, 78, 86, 88, 90, 91, 95,
99, 100; 248/441.1, 451, 452, 453, 473;
D6/300-310, 407, 626, 629; D21/392; 211/10,
11, 13.1, 41.1, 41.12, 42, 45, 50

(56) **References Cited**

U.S. PATENT DOCUMENTS

715,532 A 12/1902 Anderson
1,152,461 A * 9/1915 Wright 248/473

(Continued)

FOREIGN PATENT DOCUMENTS

JP 1760956 8/1982
JP 5924383 2/1984
JP 6323169 6/1988

OTHER PUBLICATIONS

JP Appln. 1760956 in English.

Primary Examiner—Martie K. Holtje

(74) *Attorney, Agent, or Firm*—Greenblum & Bernstein,
P.L.C.

(57) **CLAIM**

I claim the ornamental design for a paper holder, as shown
and described.

DESCRIPTION

FIG. 1 is a top and side perspective view, showing a first
embodiment of my new design;

FIG. 2 is a right side view thereof;
FIG. 3 is a left side view thereof;
FIG. 4 is a front side view thereof;
FIG. 5 is a rear side view thereof;
FIG. 6 is a top view thereof; and
FIG. 7 is a bottom view thereof.
FIG. 8 is a top and side perspective view, showing another
embodiment of my new design;
FIG. 9 is a right side view thereof;
FIG. 10 is a left side view thereof;
FIG. 11 is a front side view thereof;
FIG. 12 is a rear side view thereof;
FIG. 13 is a top view thereof; and
FIG. 14 is a bottom view thereof.
FIG. 15 is a top and side perspective view, showing another
embodiment of my new design;
FIG. 16 is a right side view thereof;
FIG. 17 is a left side view thereof;
FIG. 18 is a front side view thereof;
FIG. 19 is a rear side view thereof;
FIG. 20 is a top view thereof; and
FIG. 21 is a bottom view thereof.
FIG. 22 is a top and side perspective view, showing another
embodiment of my new design;
FIG. 23 is a right side view thereof;
FIG. 24 is a left side view thereof;
FIG. 25 is a front side view thereof;
FIG. 26 is a rear side view thereof;
FIG. 27 is a top view thereof; and
FIG. 28 is a bottom view thereof.
FIG. 29 is a top and side perspective view, showing another
embodiment of my new design;
FIG. 30 is a right side view thereof;
FIG. 31 is a left side view thereof;
FIG. 32 is a front side view thereof;
FIG. 33 is a rear side view thereof;
FIG. 34 is a top view thereof; and,
FIG. 35 is a bottom view thereof.
The subject matter shown in dashed lines and any surfaces
not shown form no part of the claimed invention.

1 Claim, 18 Drawing Sheets

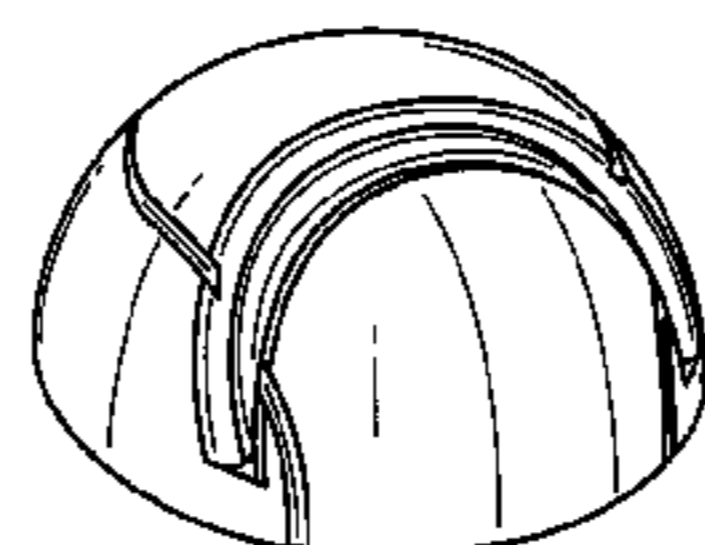
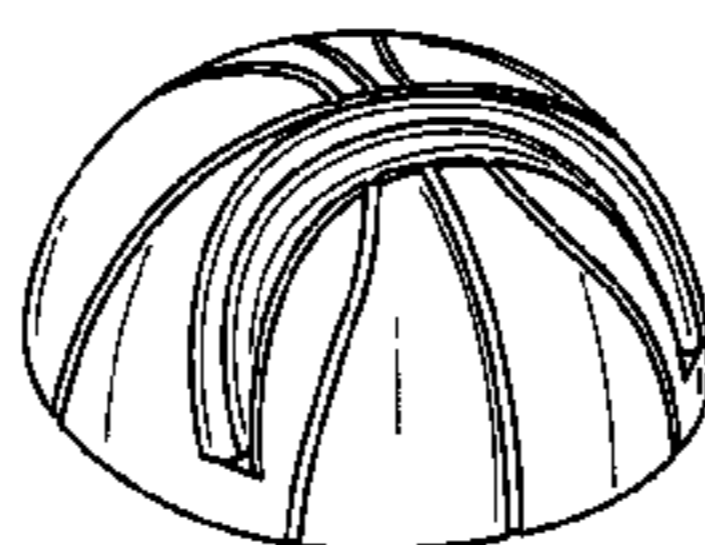
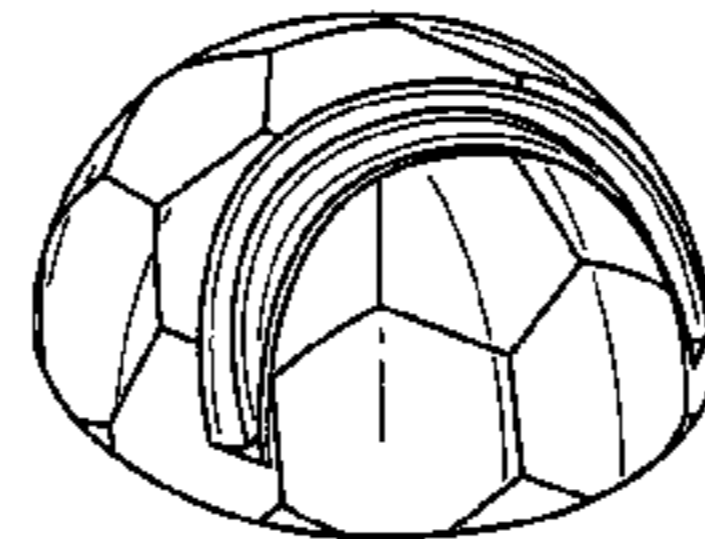
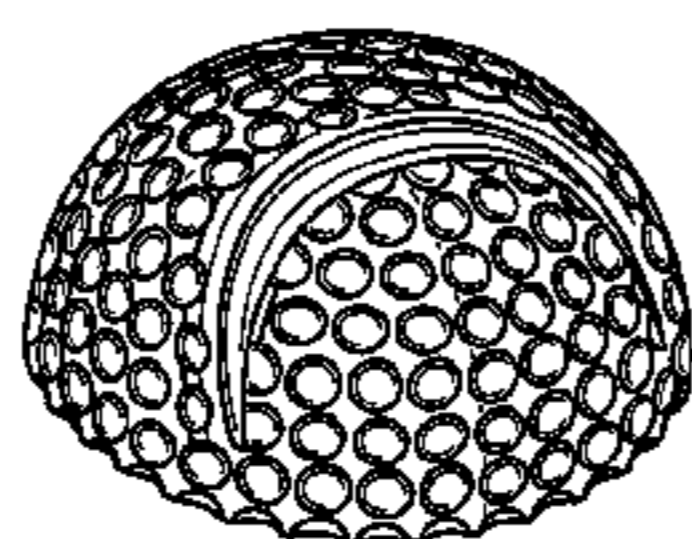

US D507,305 S

Page 2

U.S. PATENT DOCUMENTS

D48,746 S	3/1916	Foster	
1,630,373 A	5/1927	Combs	
D101,143 S	9/1936	Shank	
2,497,418 A	2/1950	Schroeder, Jr.	
D181,114 S	10/1957	Harcourt Turner	
2,832,176 A	4/1958	Vergeer	
4,125,243 A	11/1978	Liptak	
D292,991 S	* 12/1987	Adler	D19/78
D293,690 S	* 1/1988	Adler	D19/78
D327,775 S	* 7/1992	Turner	D9/307 X
D348,484 S	7/1994	Blackwell et al.	
D366,064 S	* 1/1996	Milojevich	D19/90
D366,675 S	* 1/1996	Milojevich	D19/90
D390,778 S	* 2/1998	Lee	D9/307
D407,440 S	3/1999	Vanlandingham, Jr.	
D413,931 S	* 9/1999	Ancona et al.	D19/90
D418,166 S	12/1999	Dill	
D425,706 S	* 5/2000	Calderone	D9/307 X
D426,853 S	6/2000	Clubbe	
D433,066 S	* 10/2000	Porter	D19/90
D436,627 S	* 1/2001	Bardet	D19/90
D444,179 S	6/2001	Dill	
D448,418 S	* 9/2001	Langenbach	D19/90

* cited by examiner

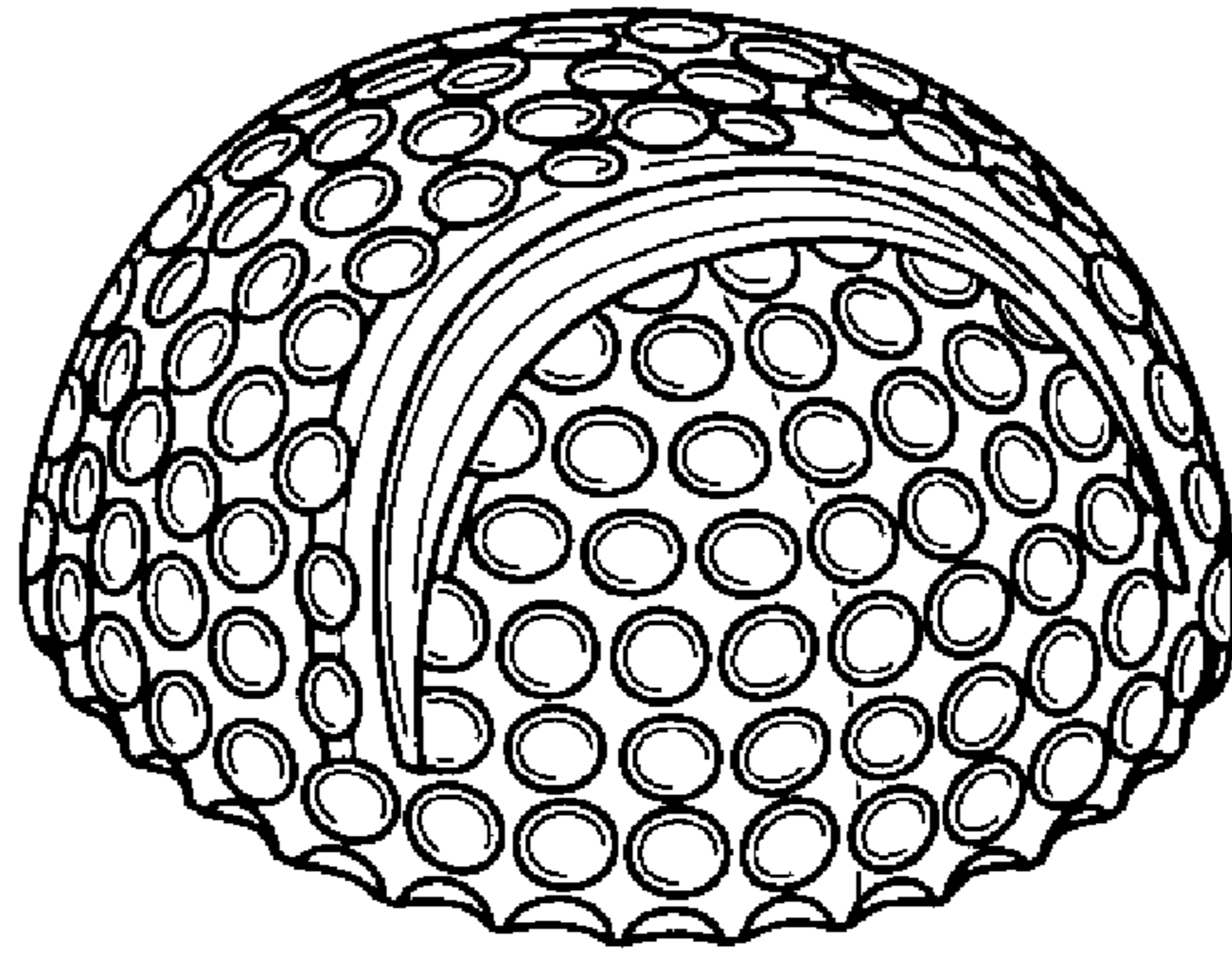

FIG. 1

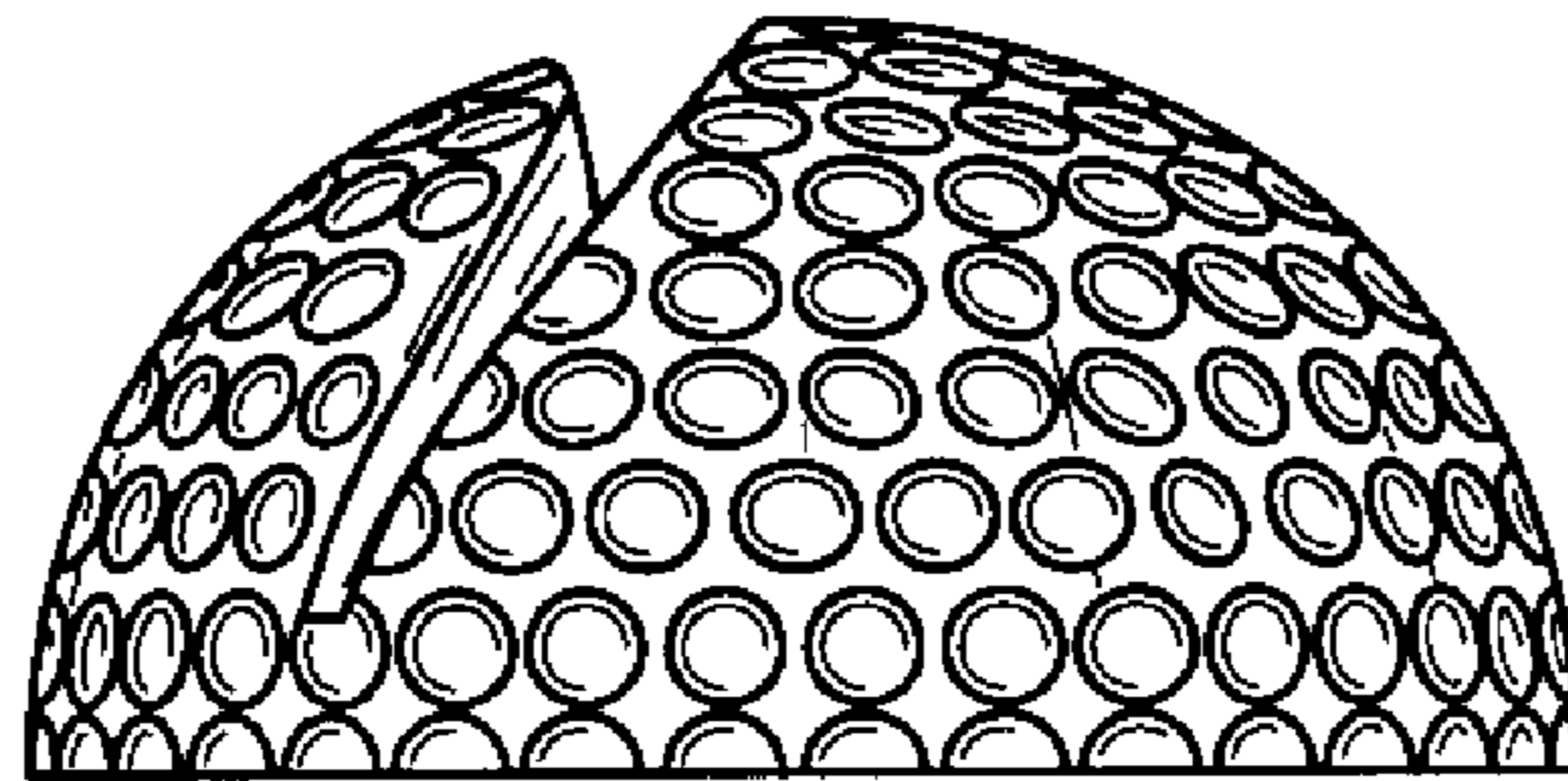

FIG. 2

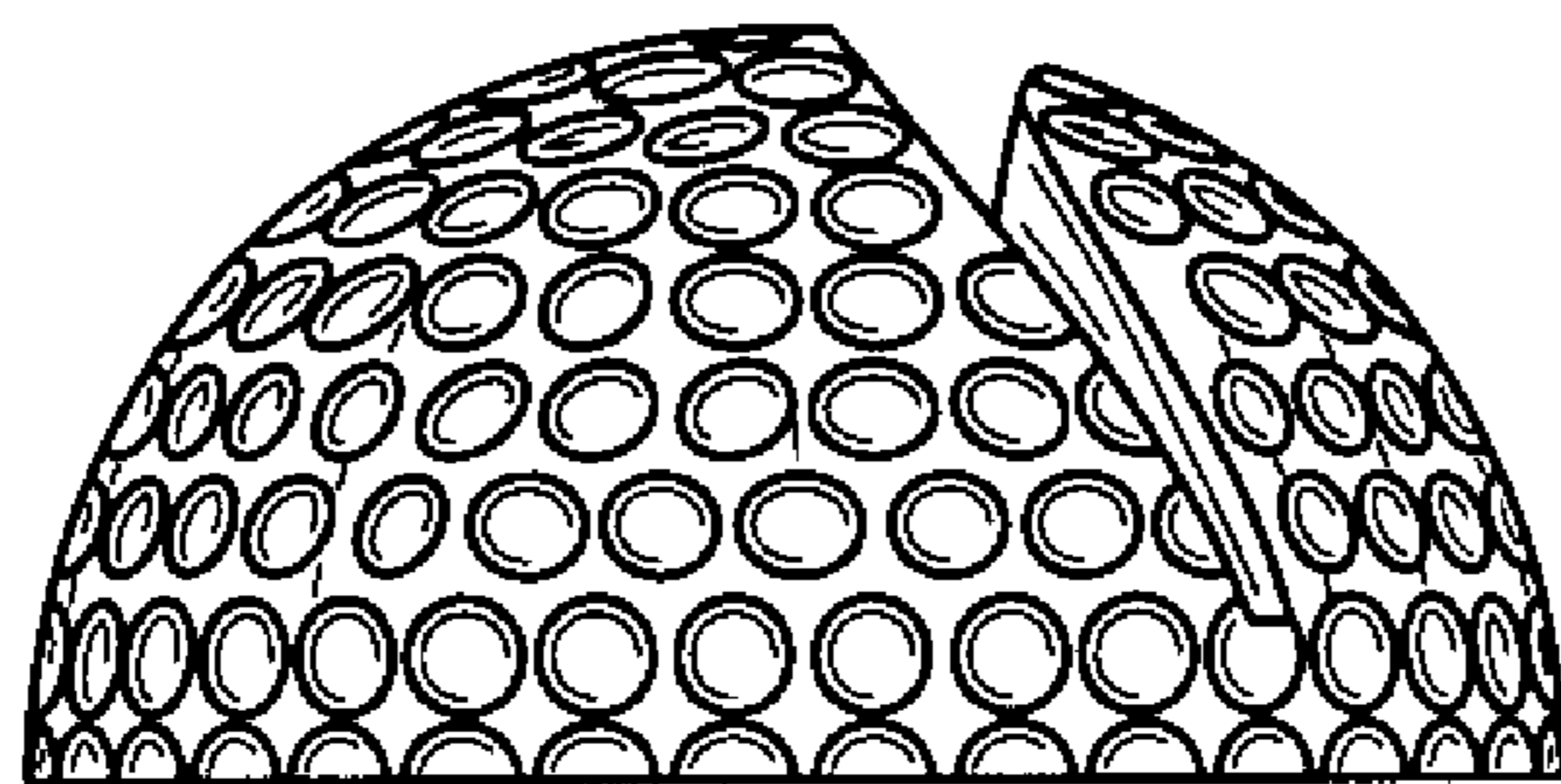

FIG. 3

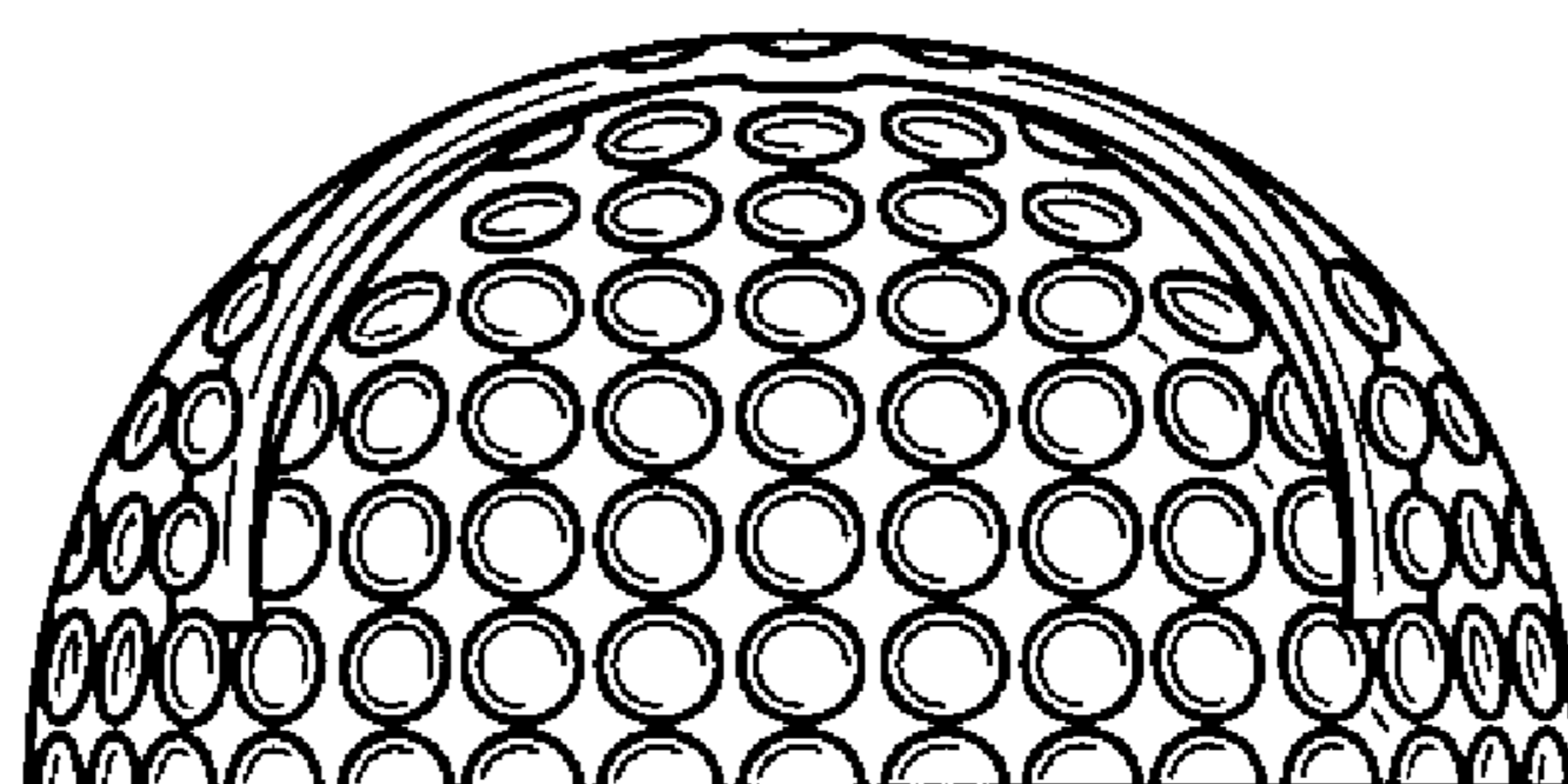

FIG. 4

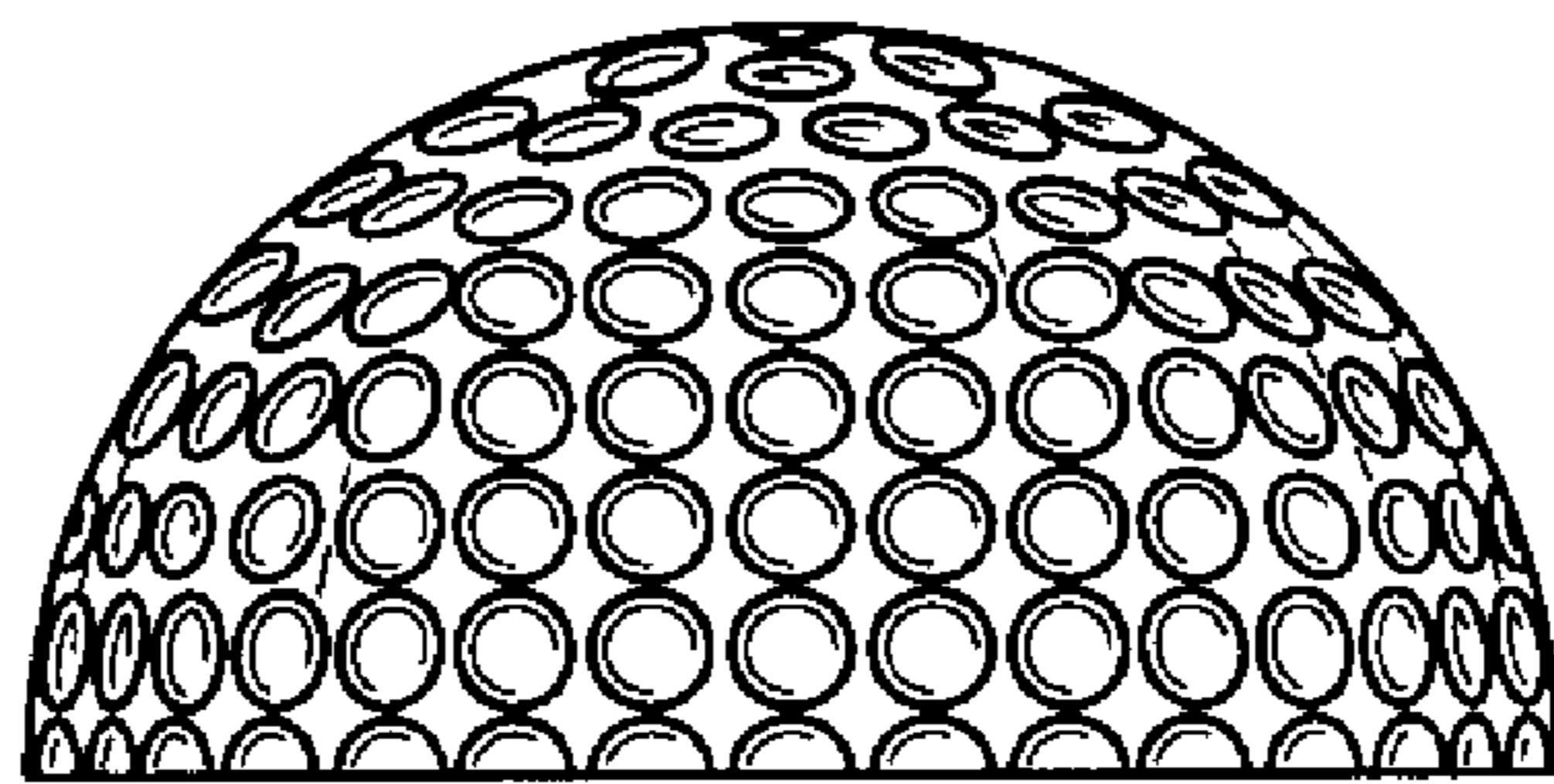

FIG. 5

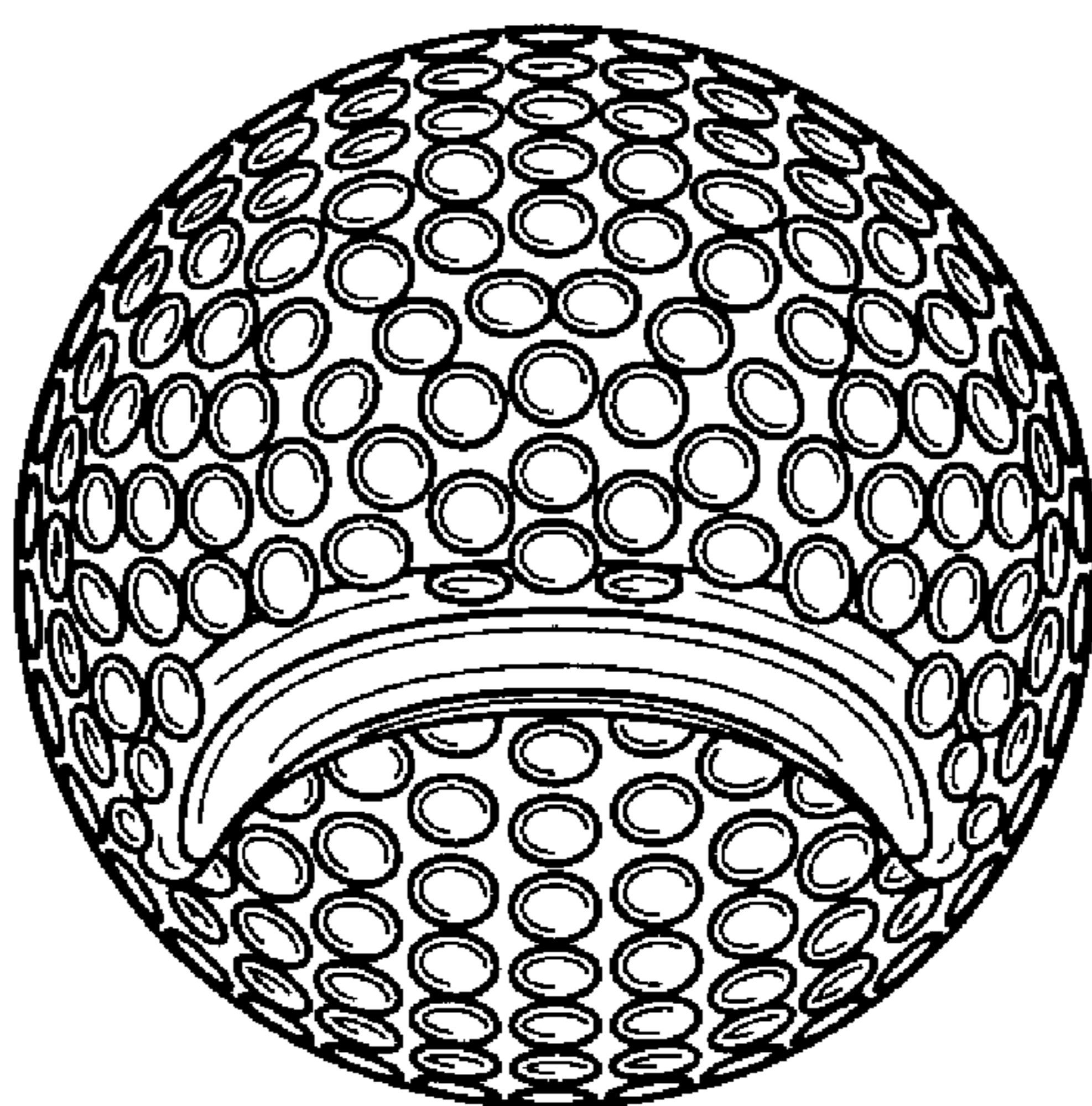

FIG. 6

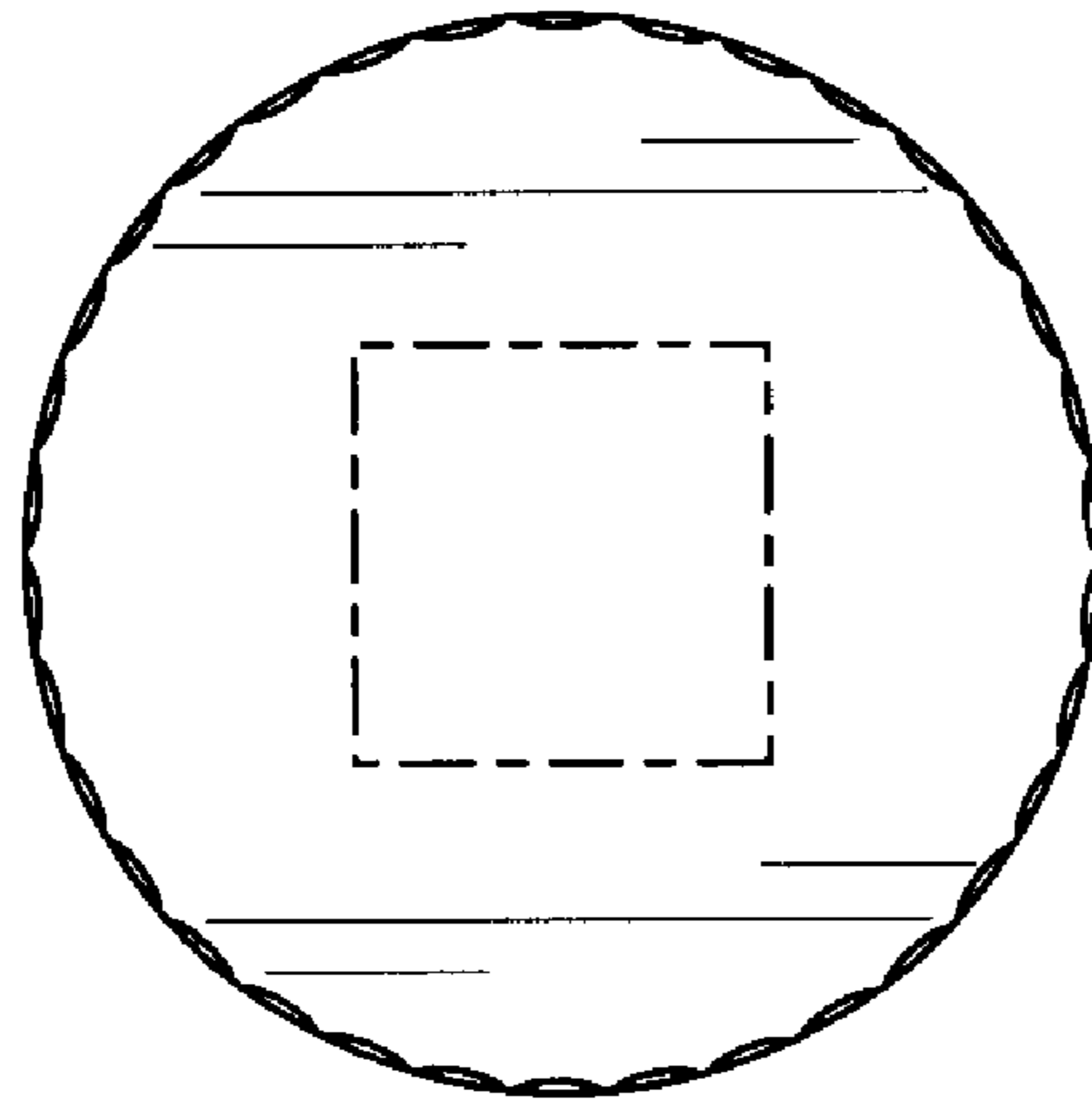

FIG. 7

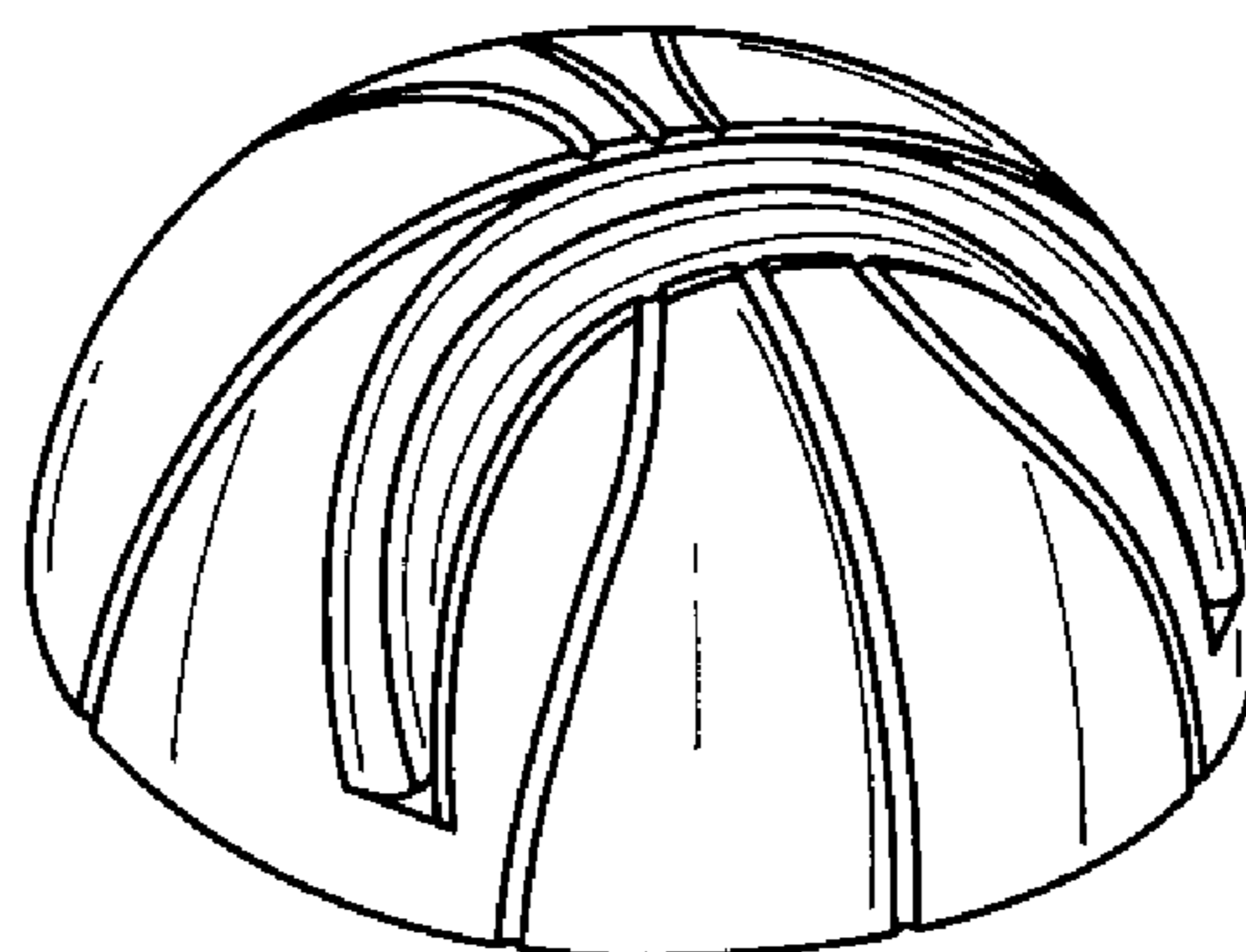

FIG. 8

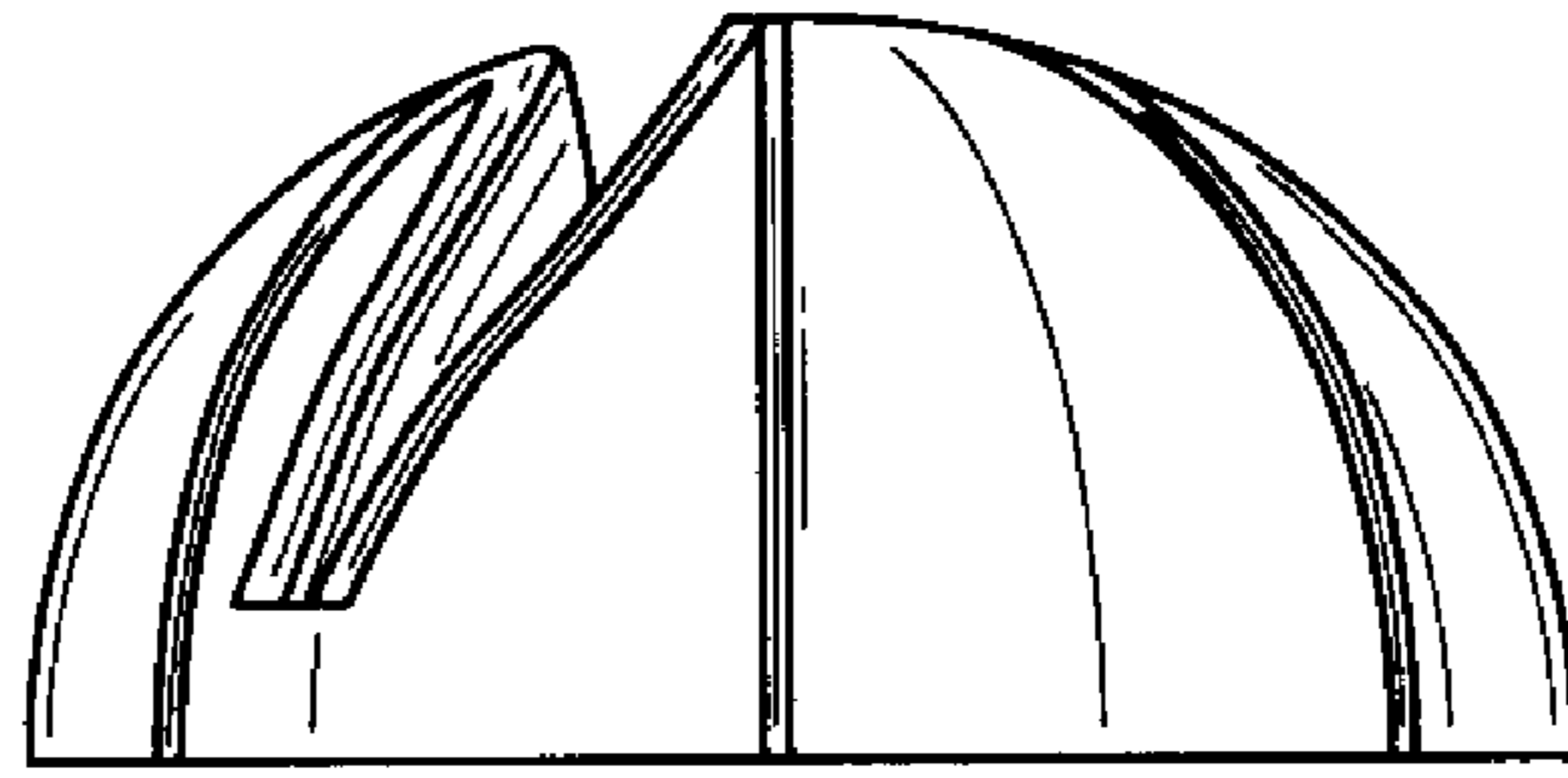

FIG. 9

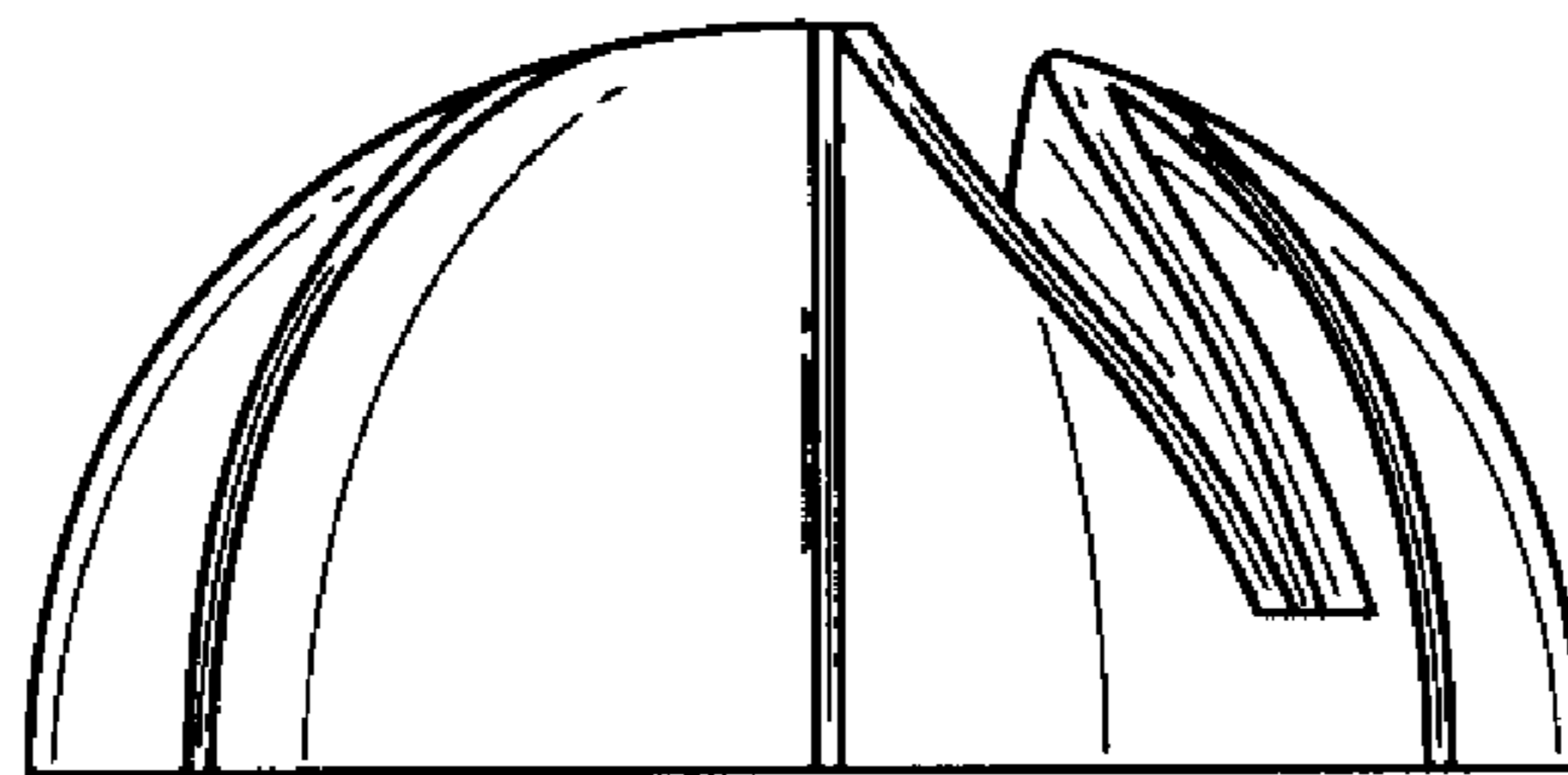

FIG. 10

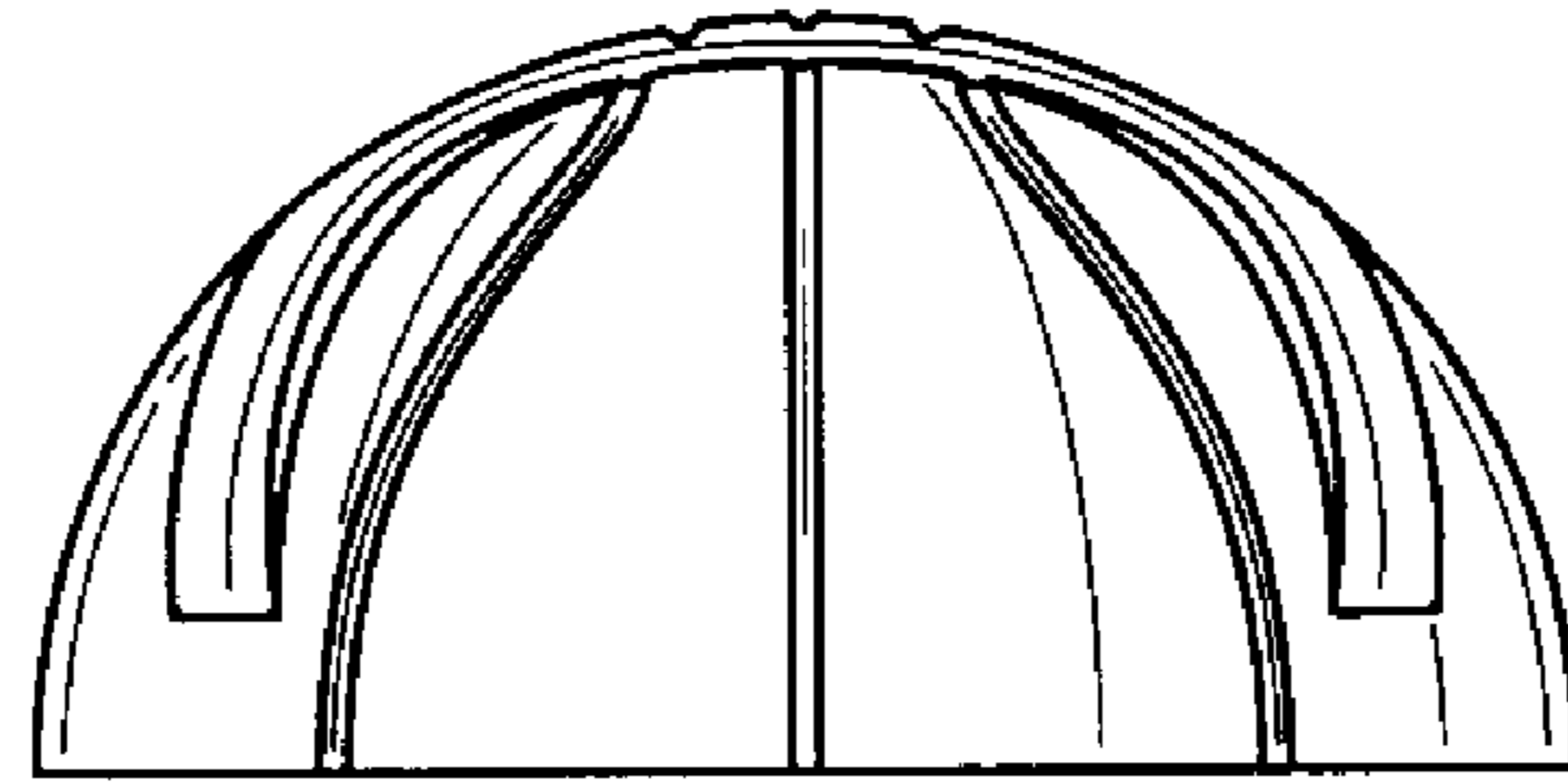

FIG. 11

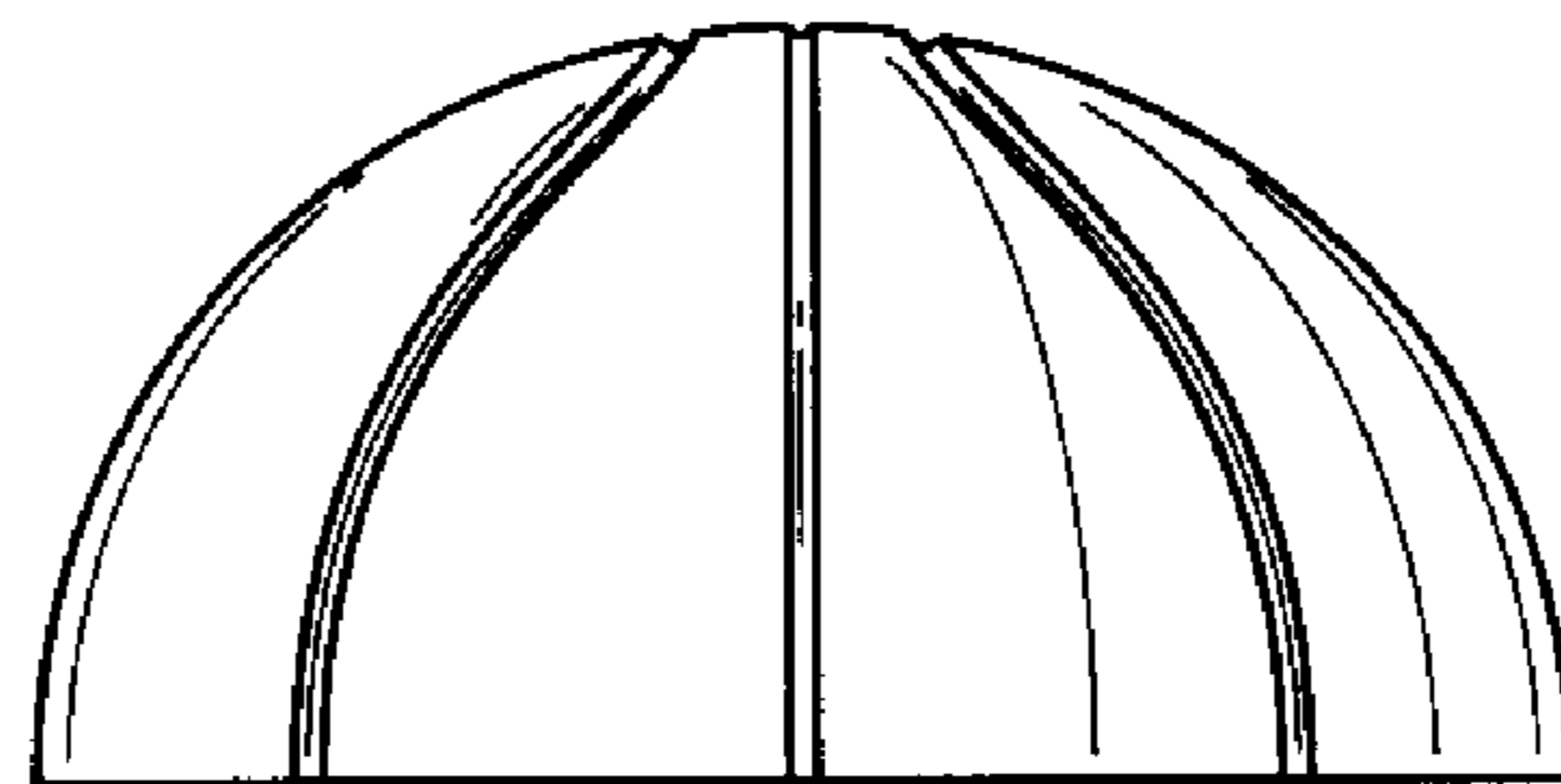

FIG. 12

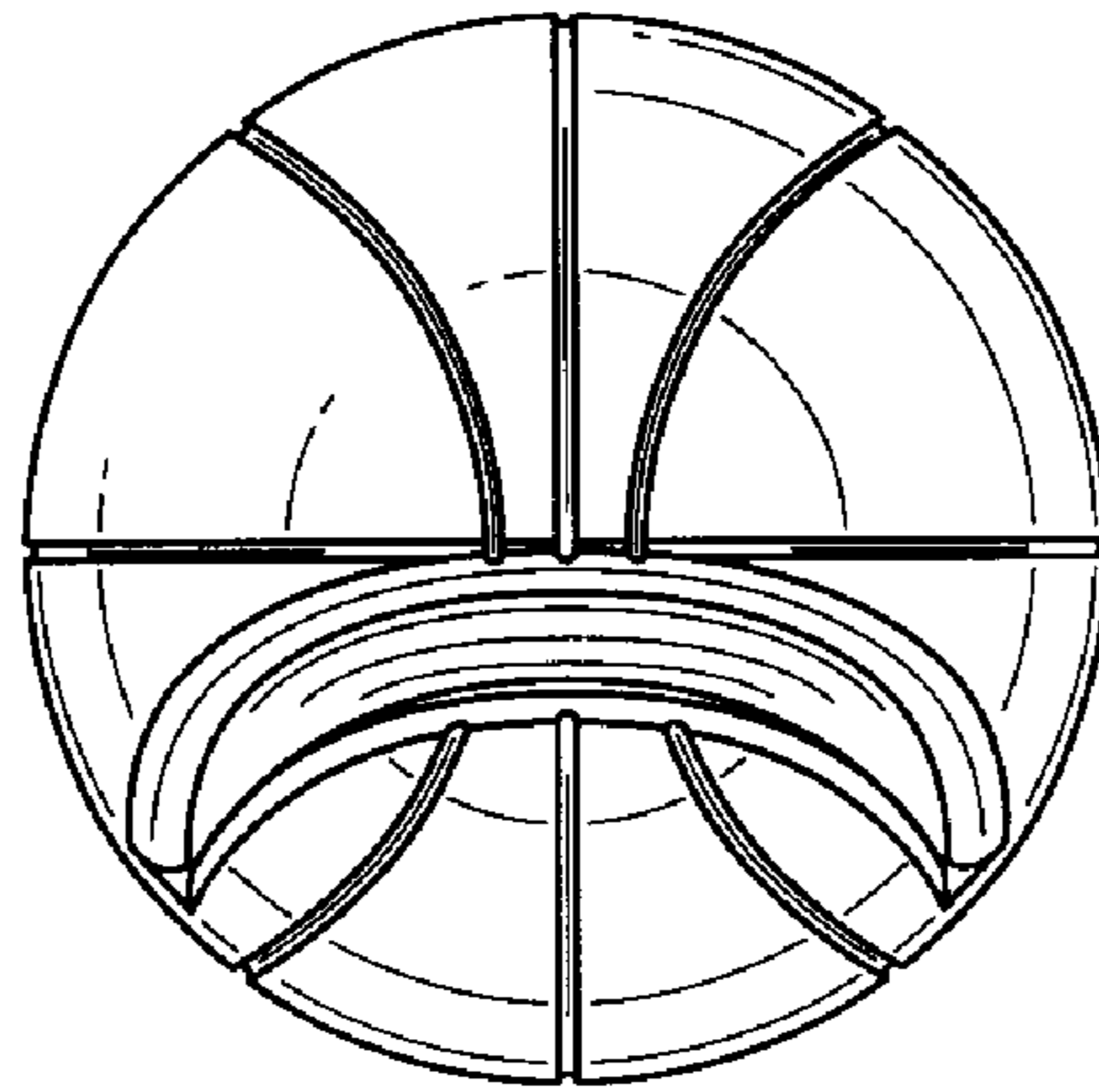

FIG. 13

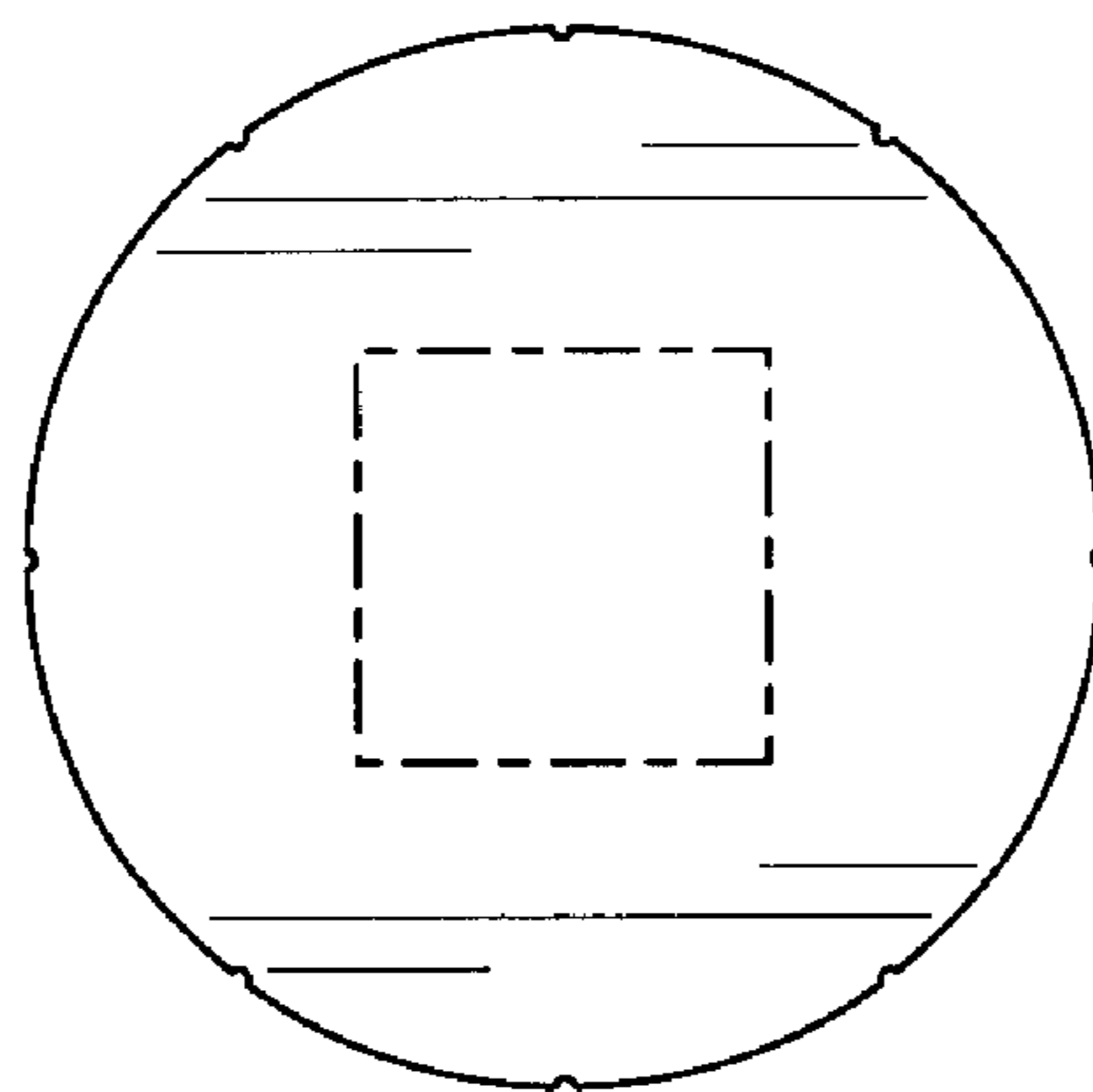

FIG. 14

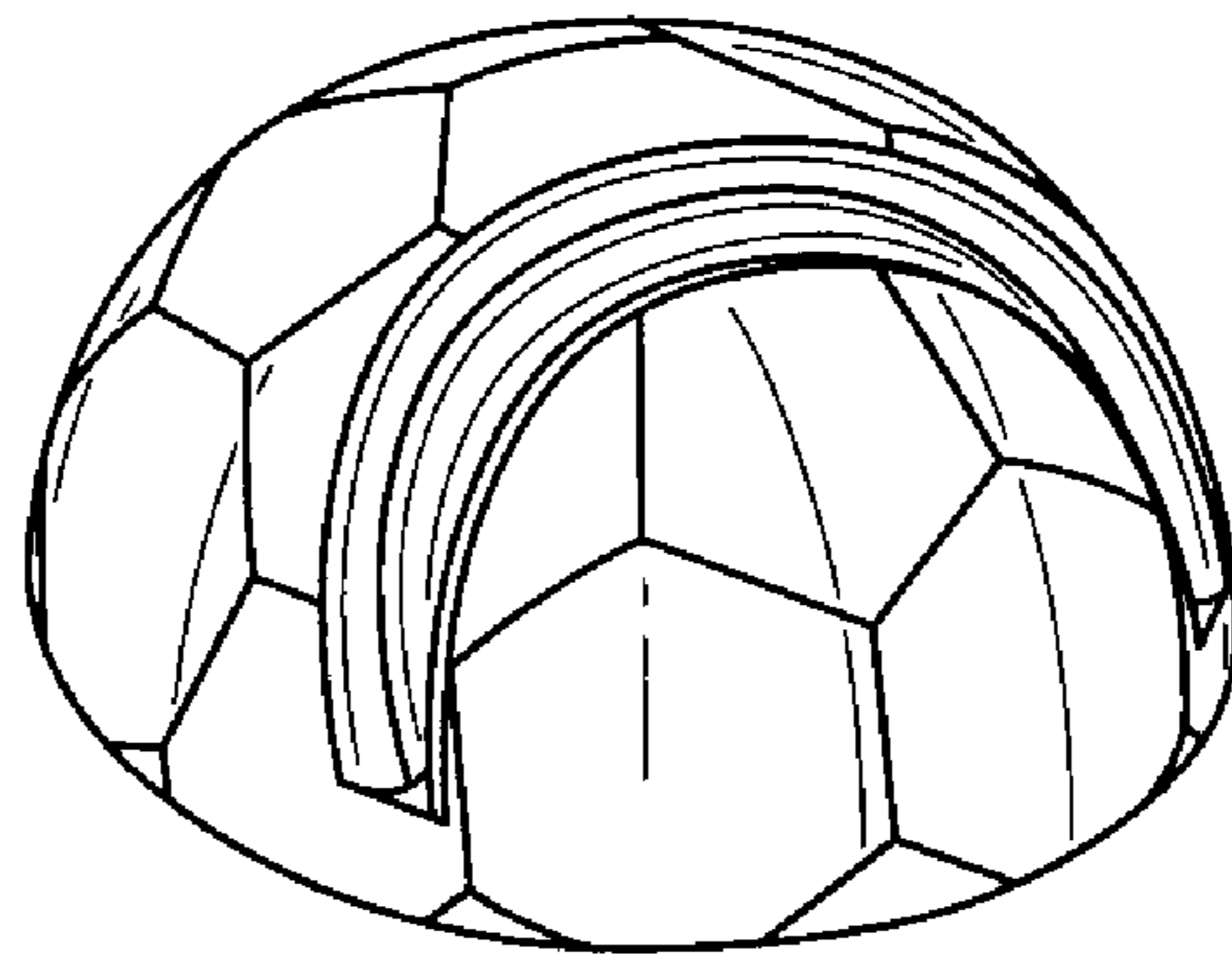

FIG. 15

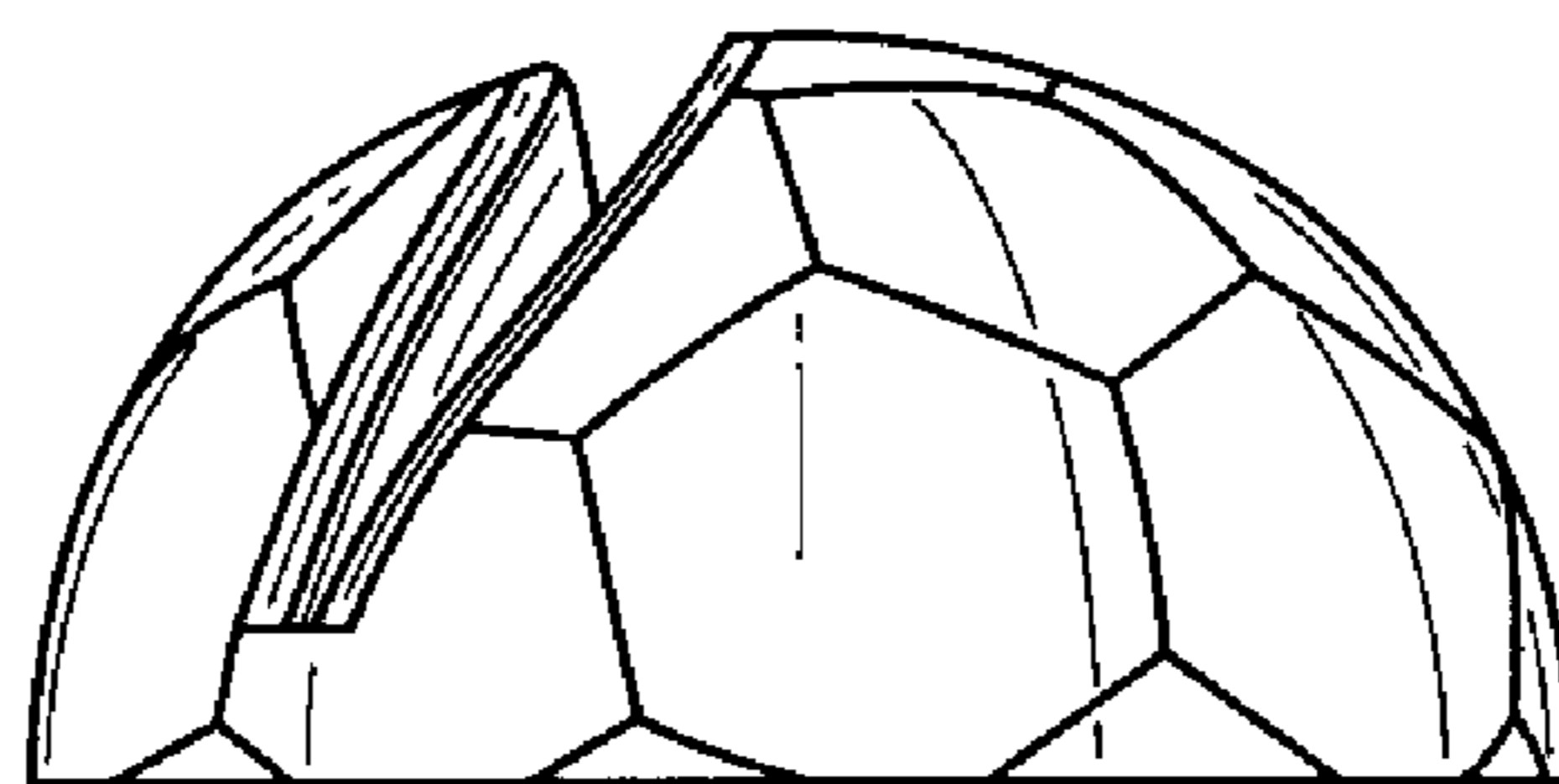

FIG. 16

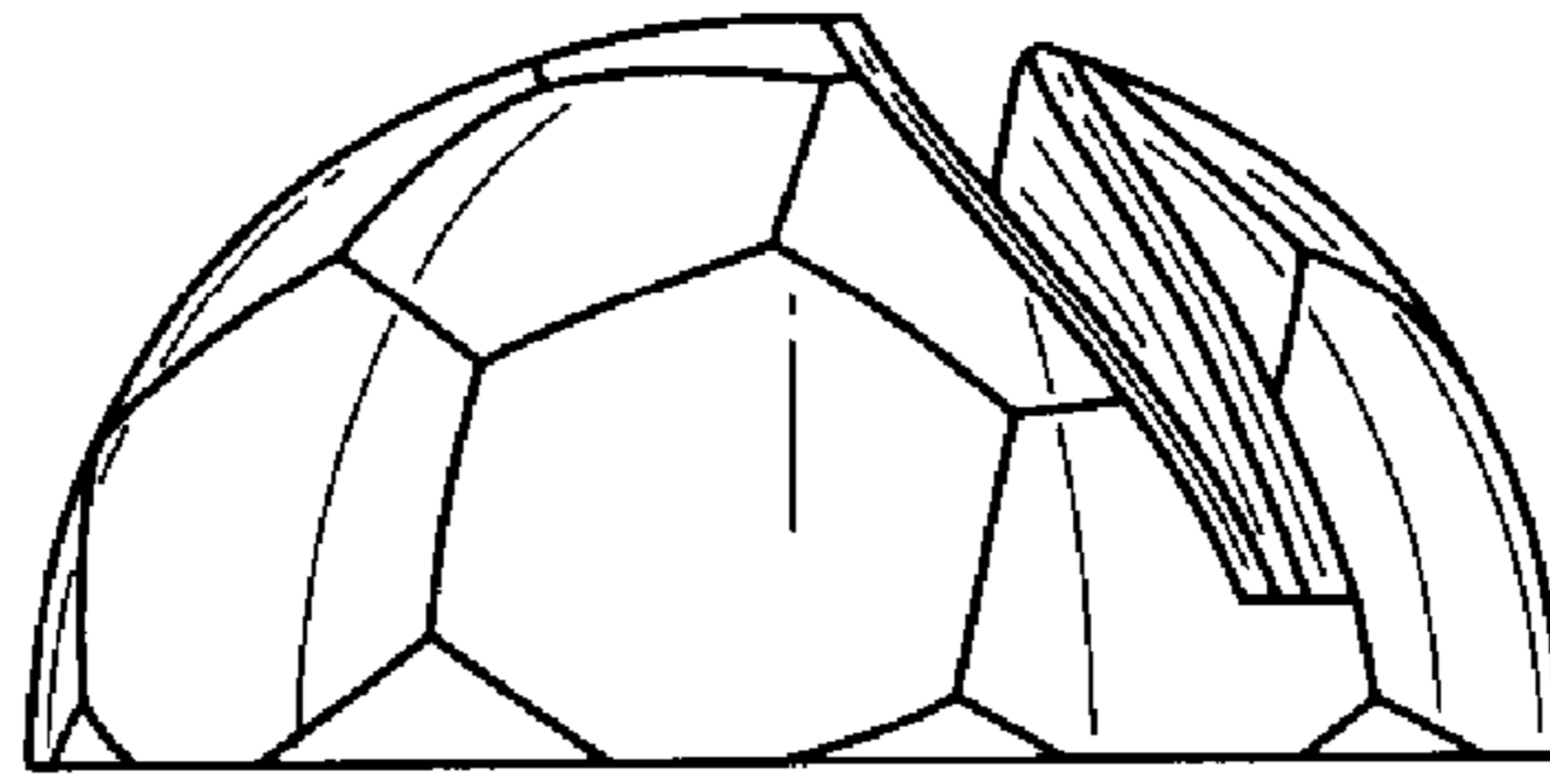

FIG. 17

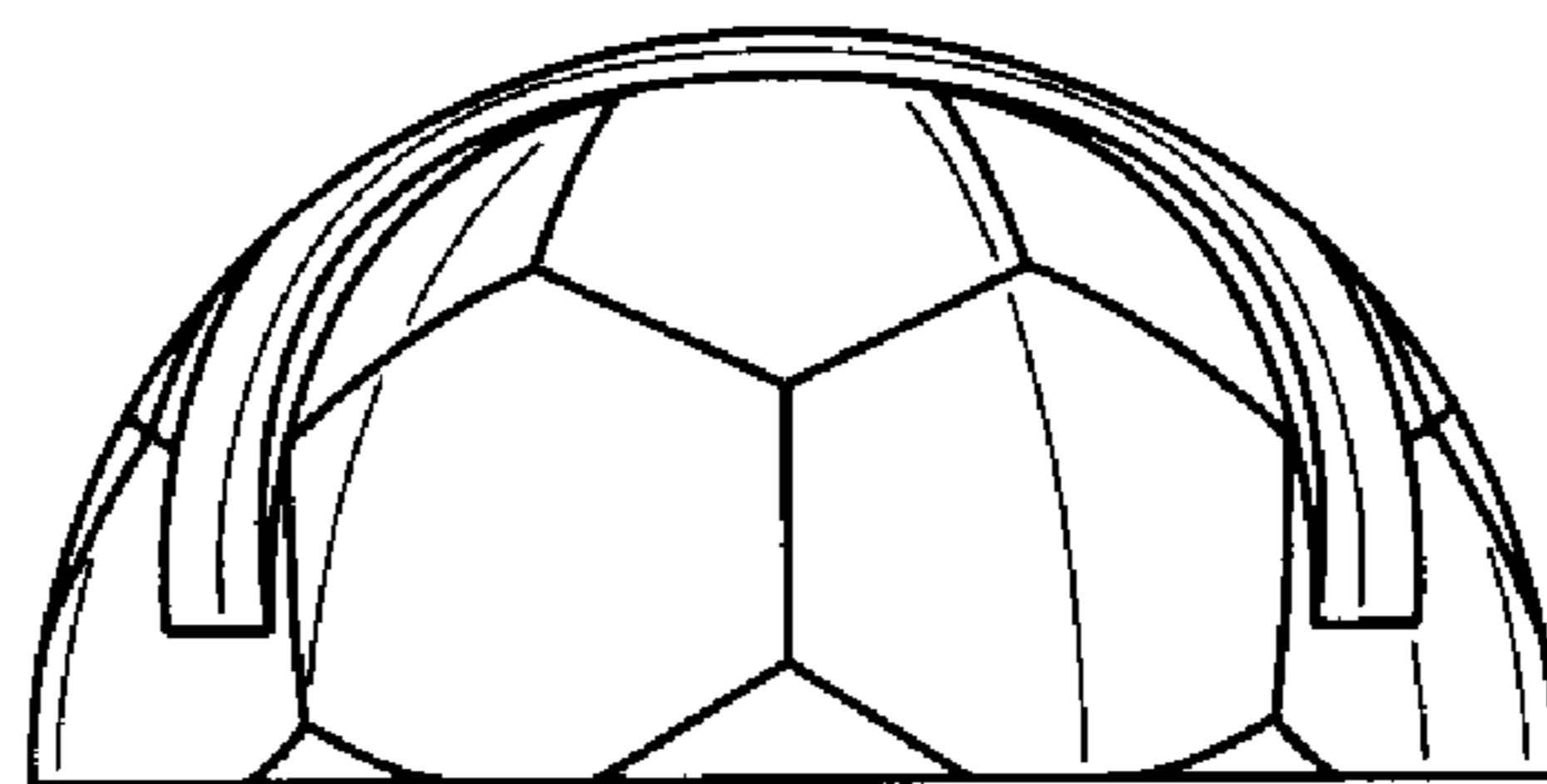

FIG. 18

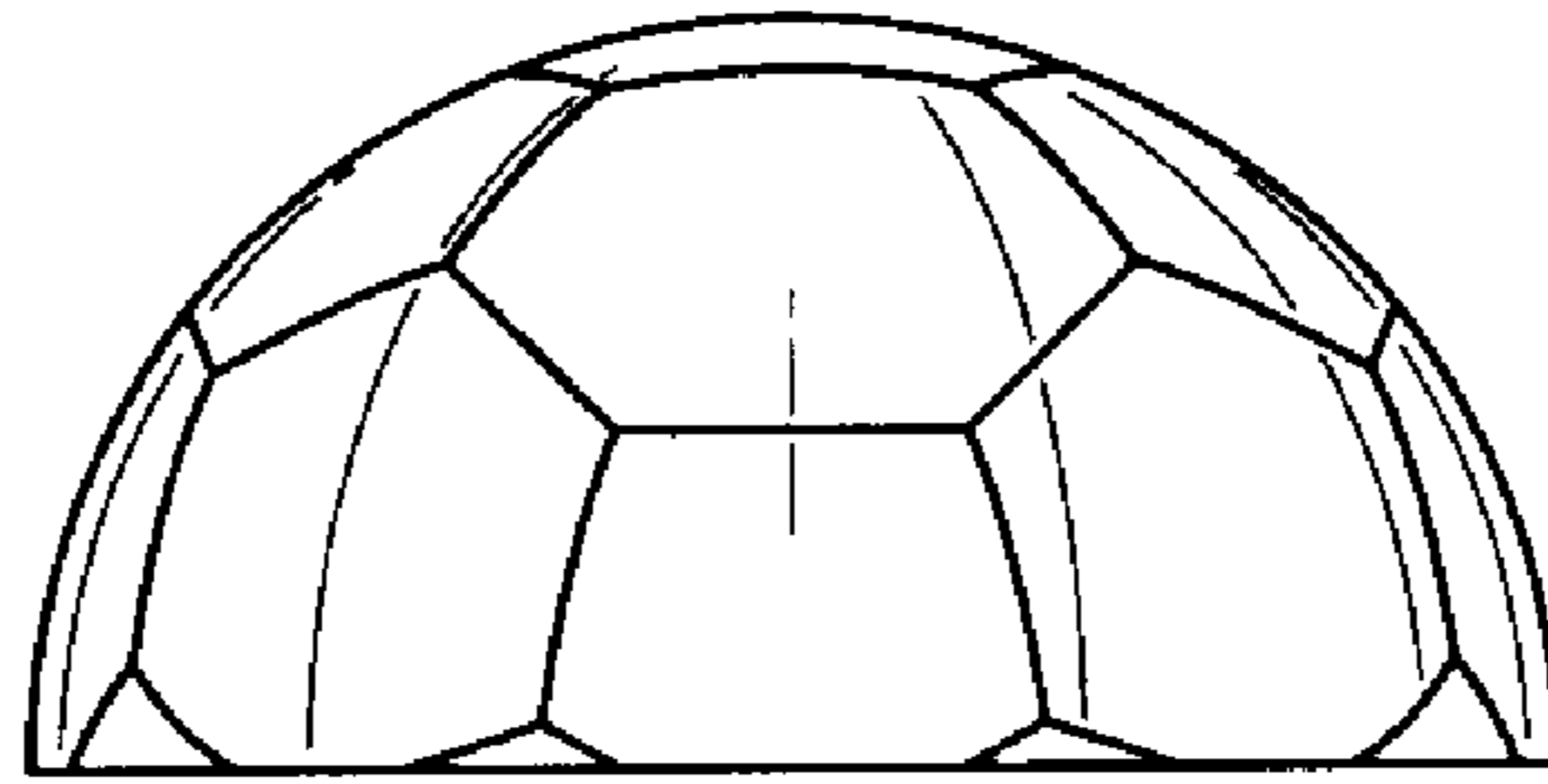

FIG. 19

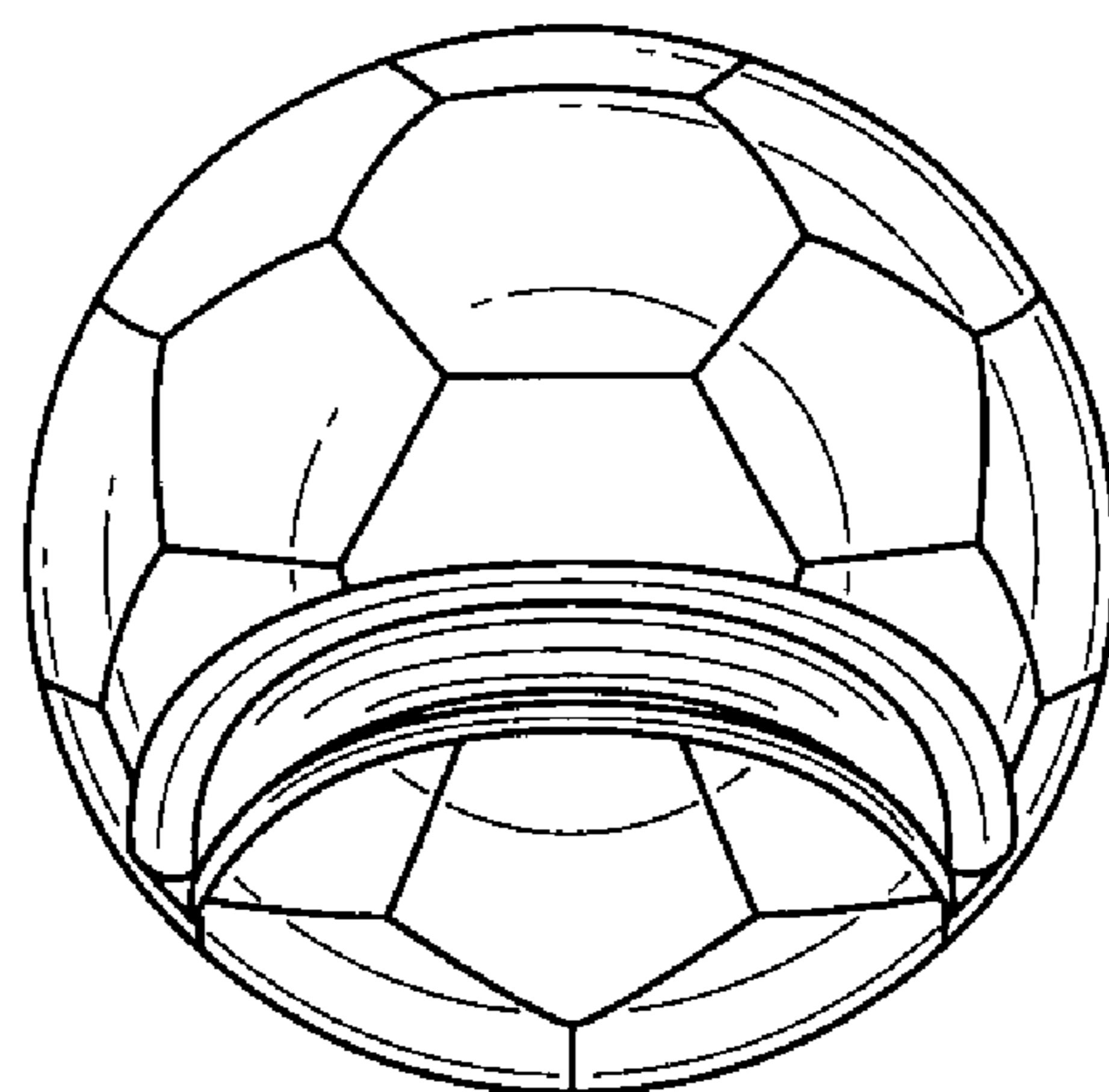

FIG. 20

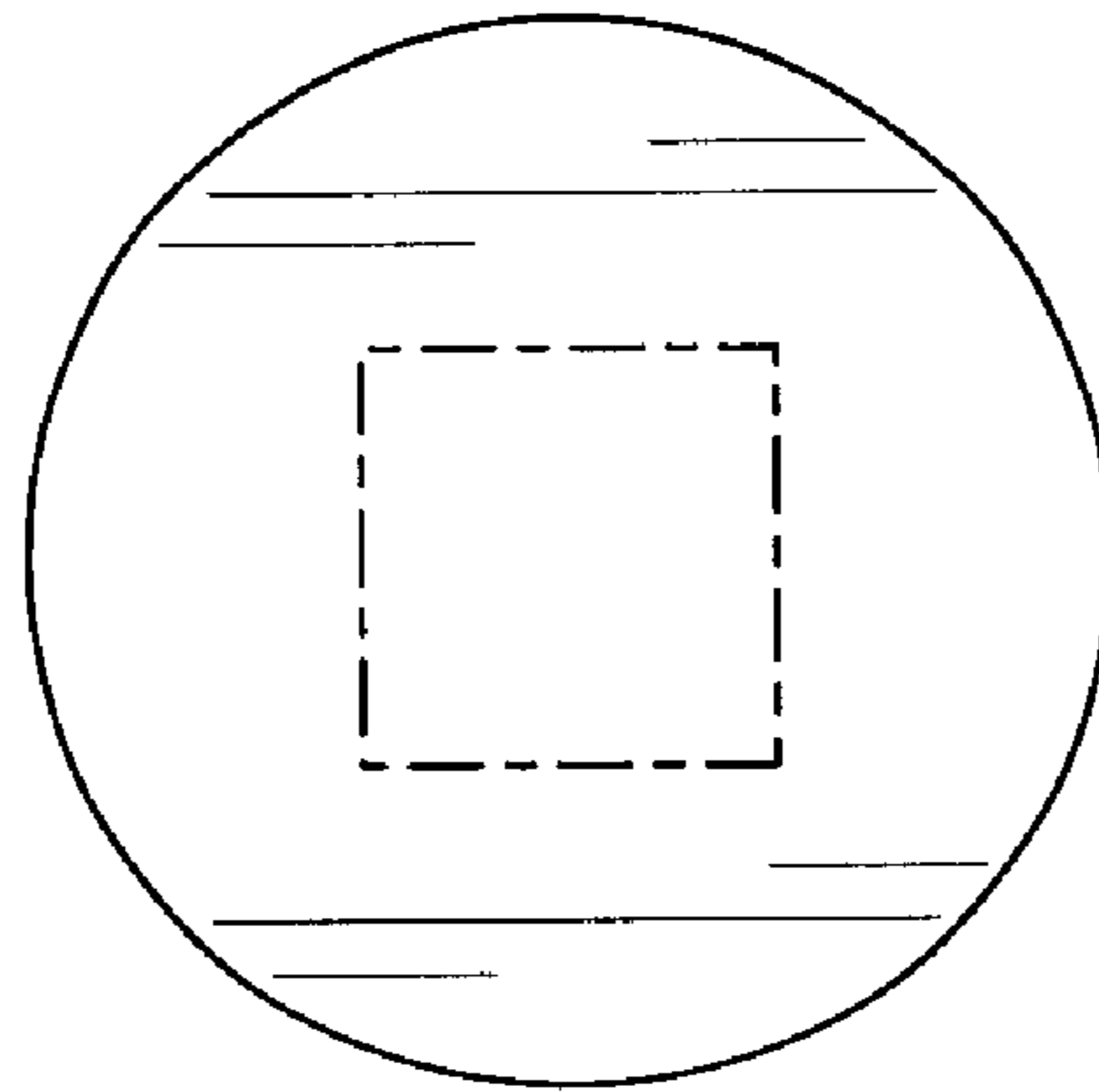

FIG. 21

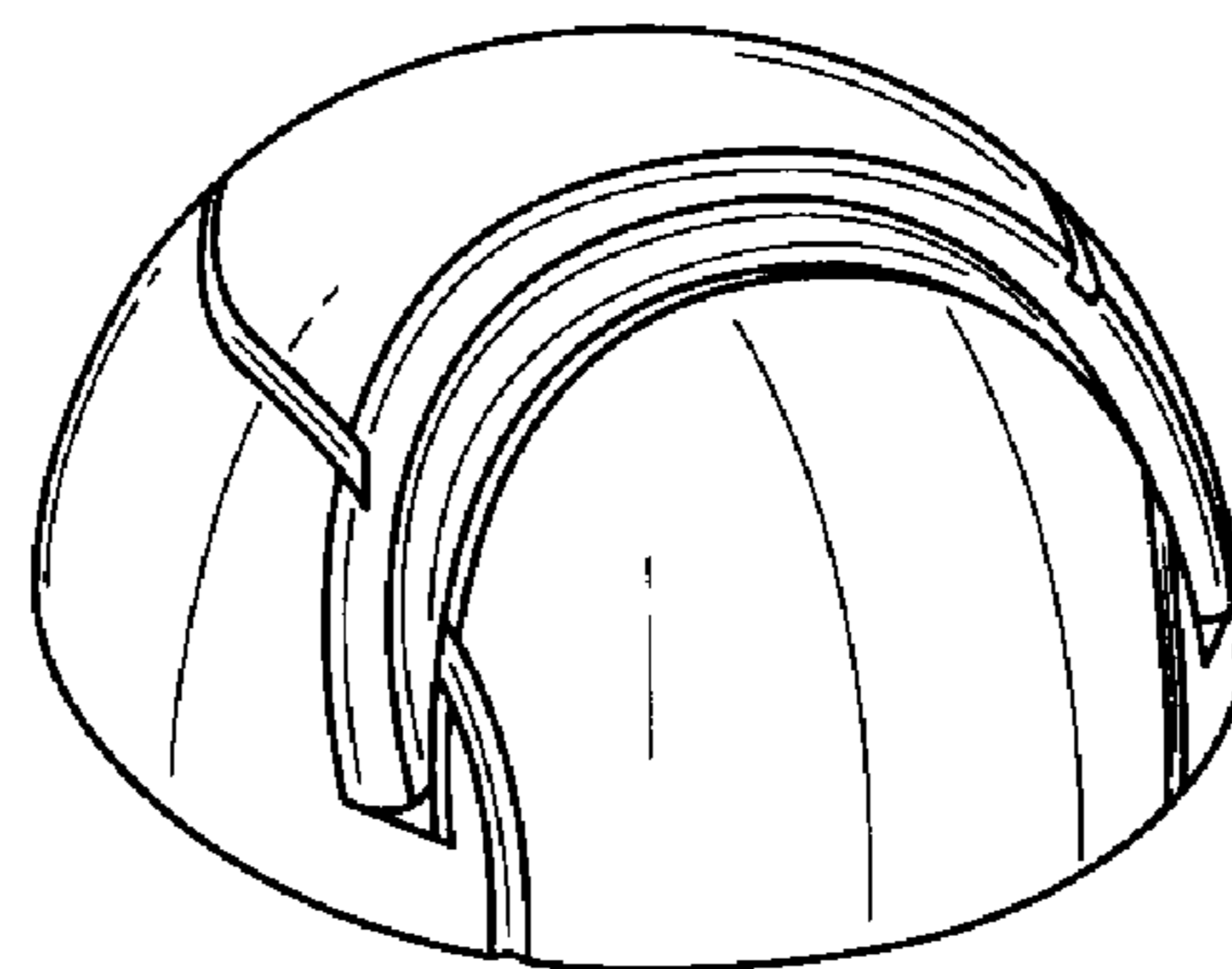

FIG. 22

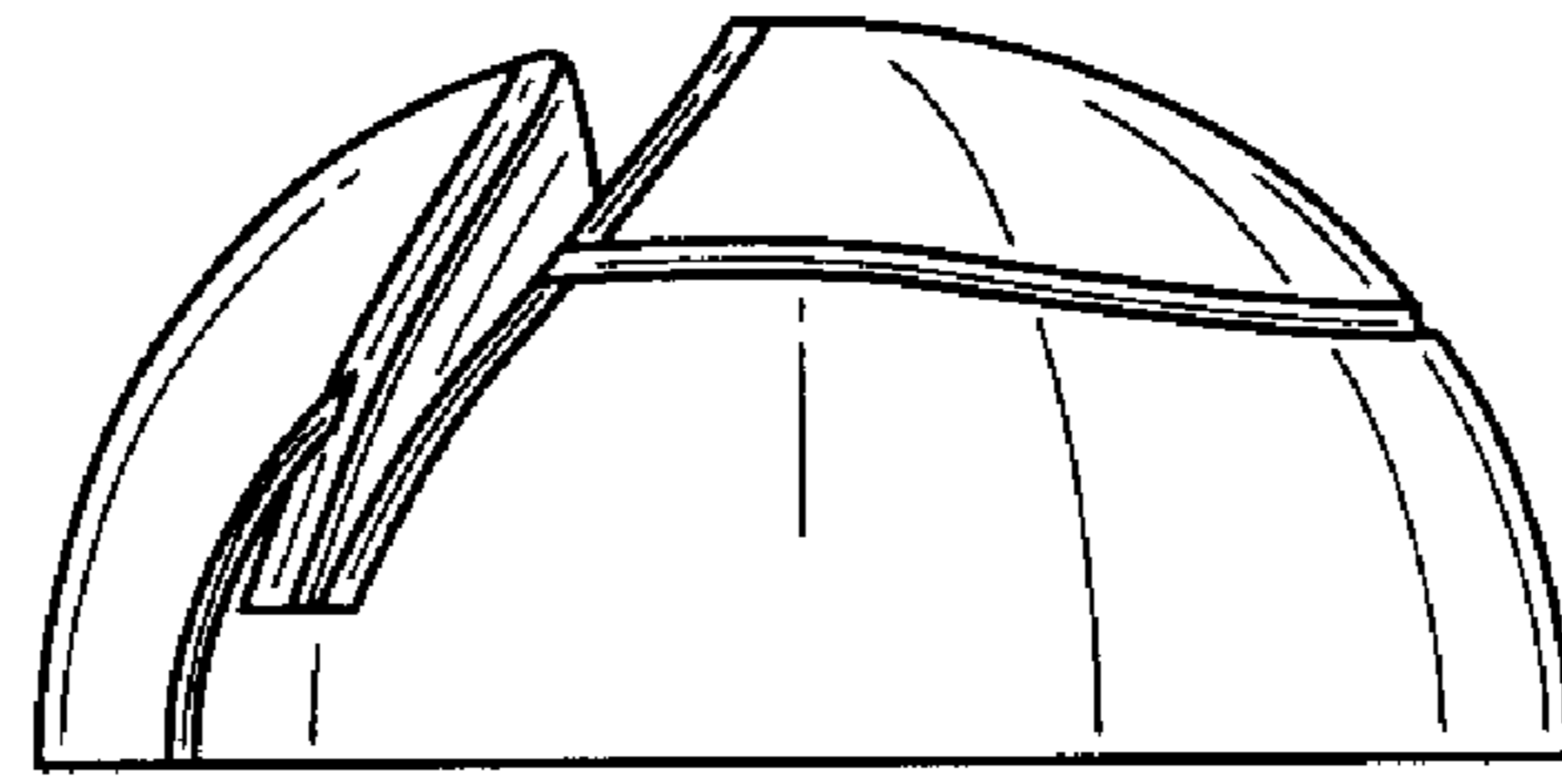

FIG. 23

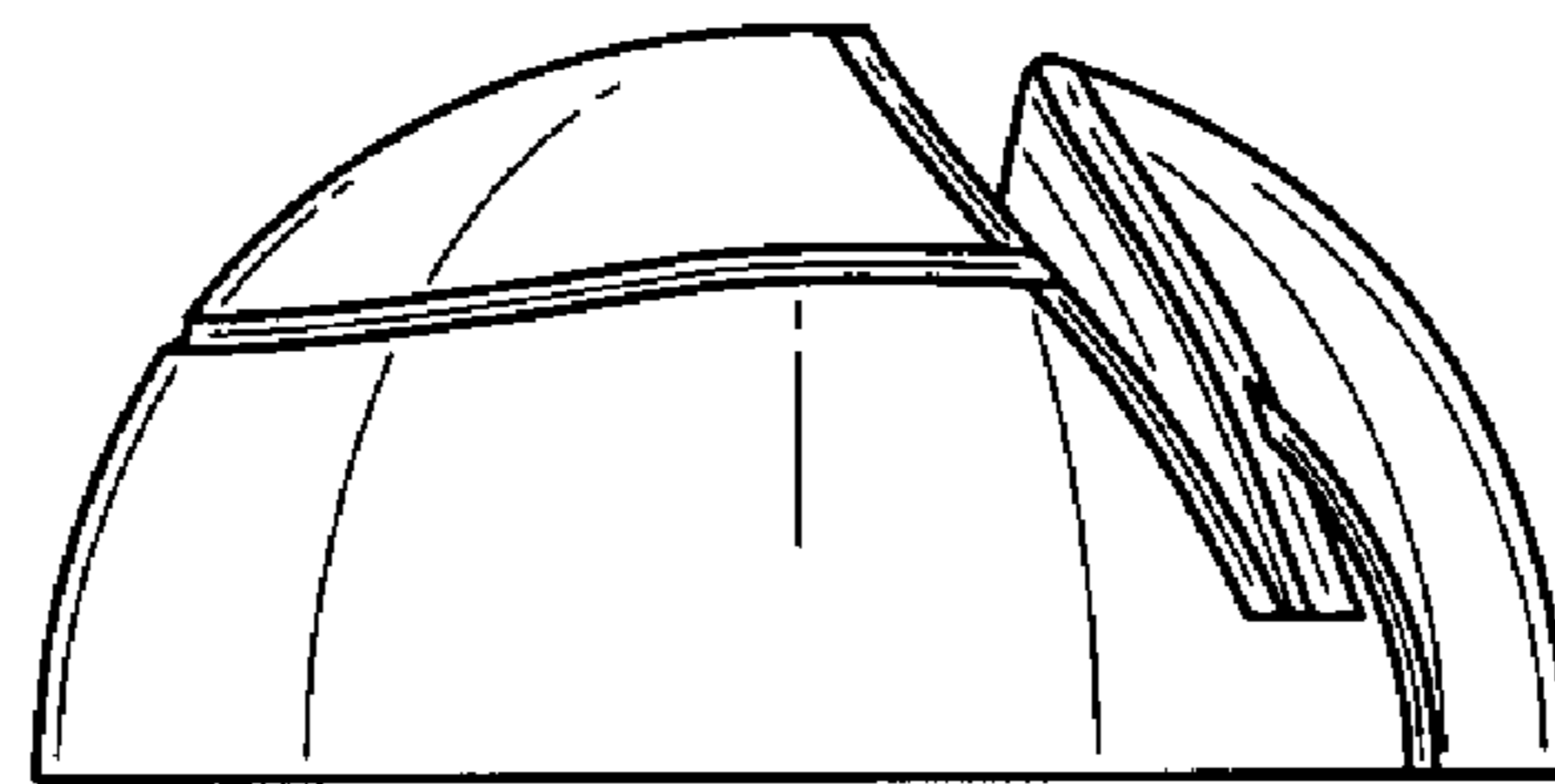

FIG. 24

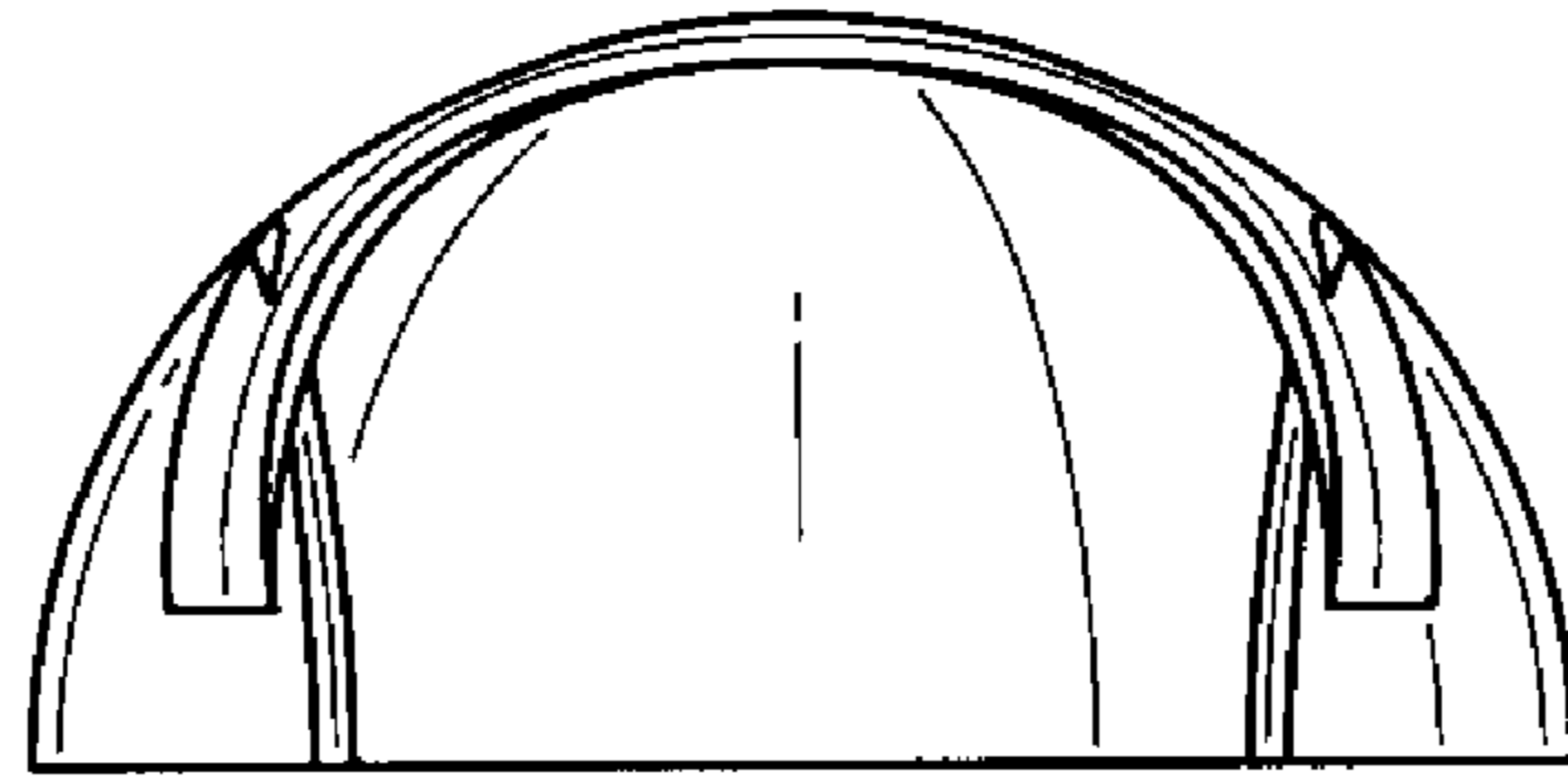

FIG. 25

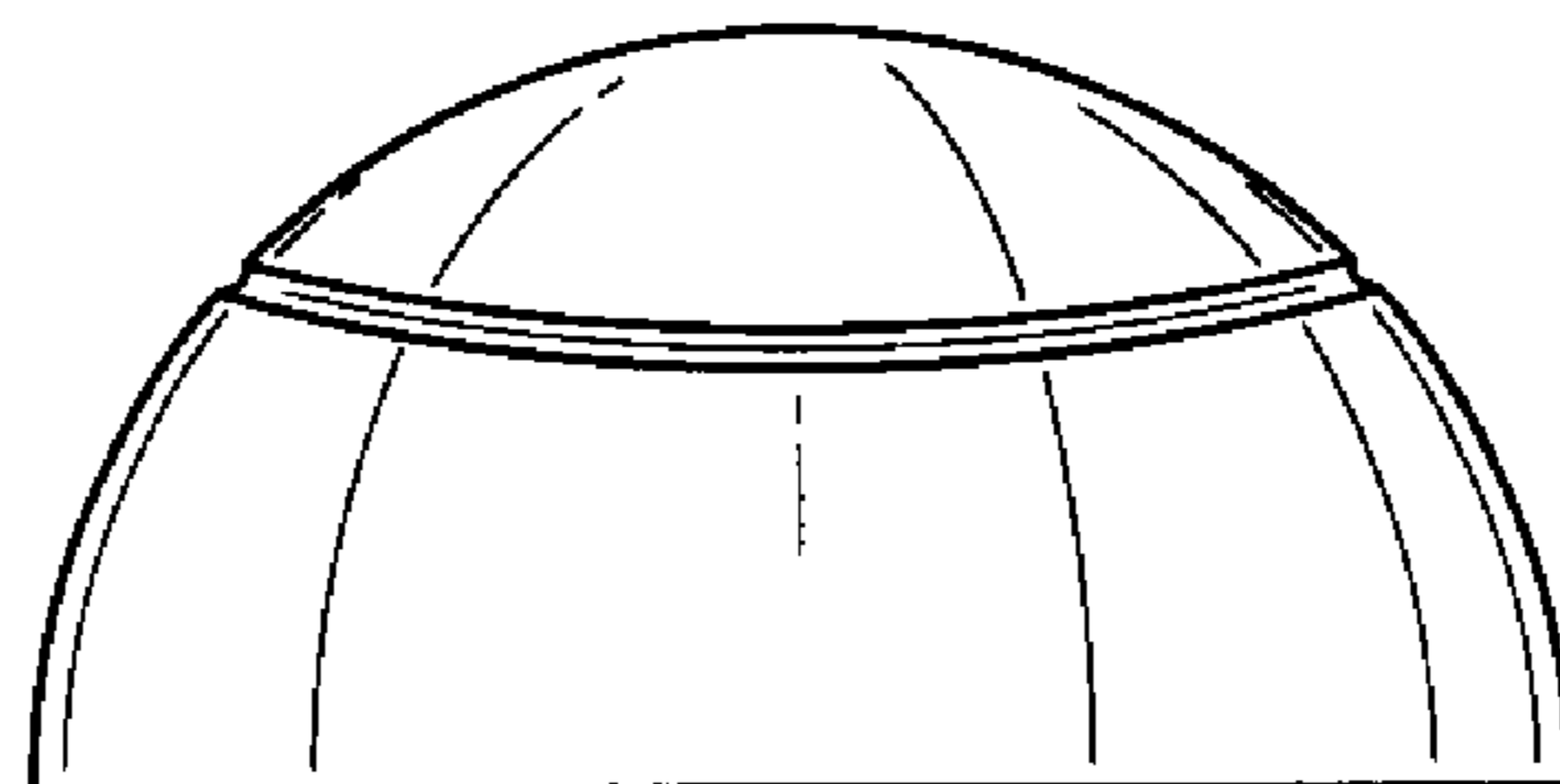

FIG. 26

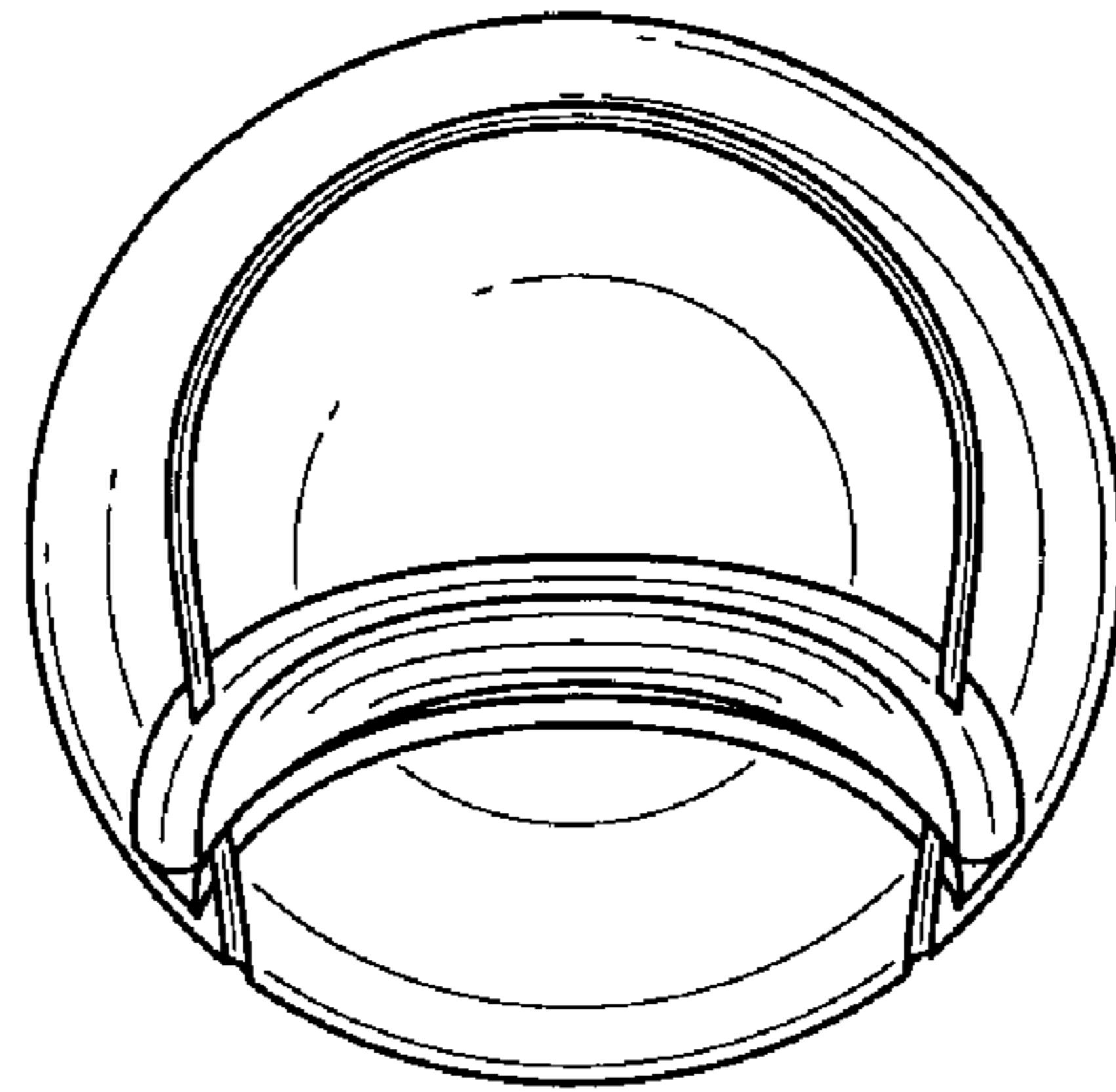

FIG. 27

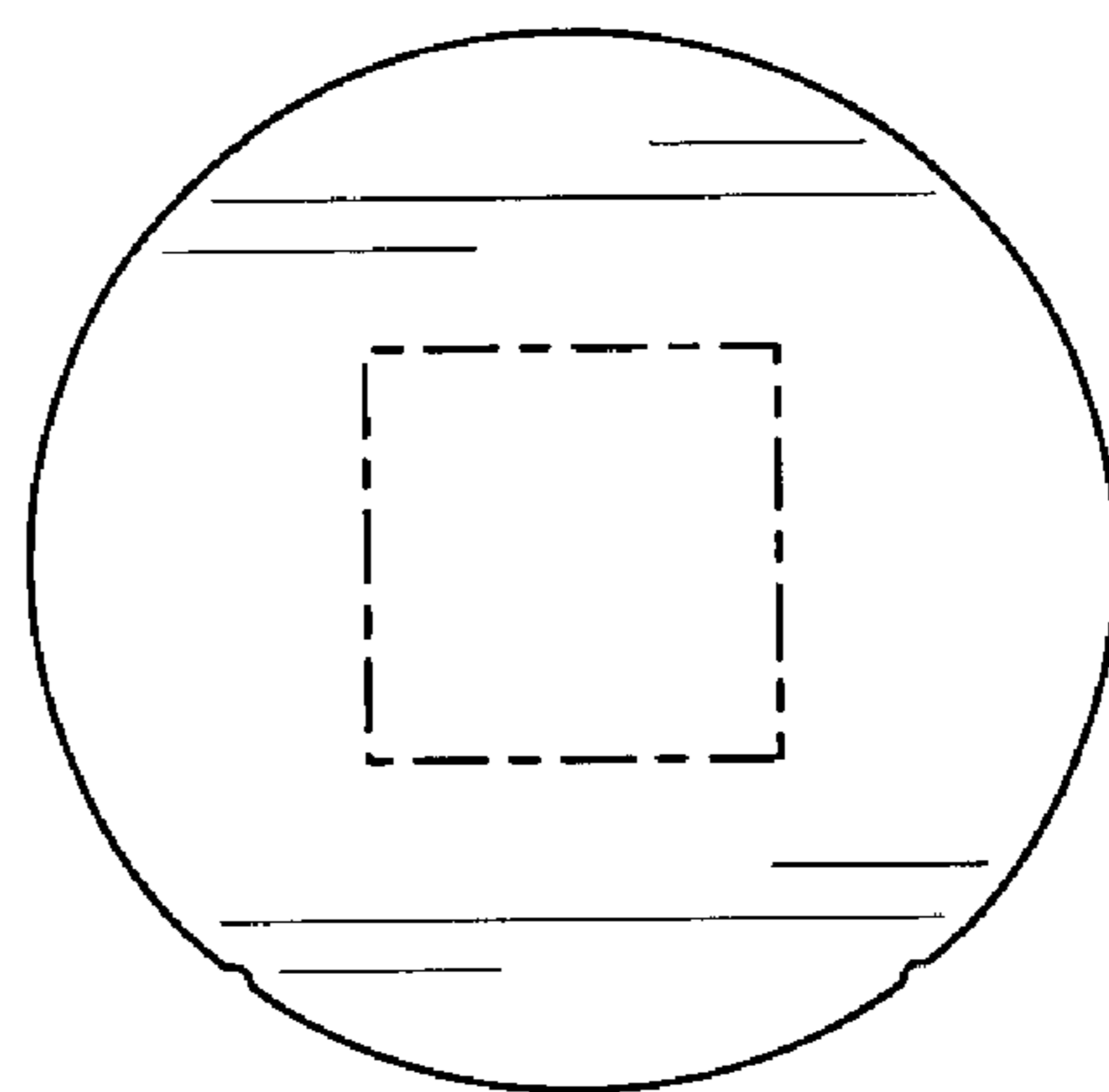

FIG. 28

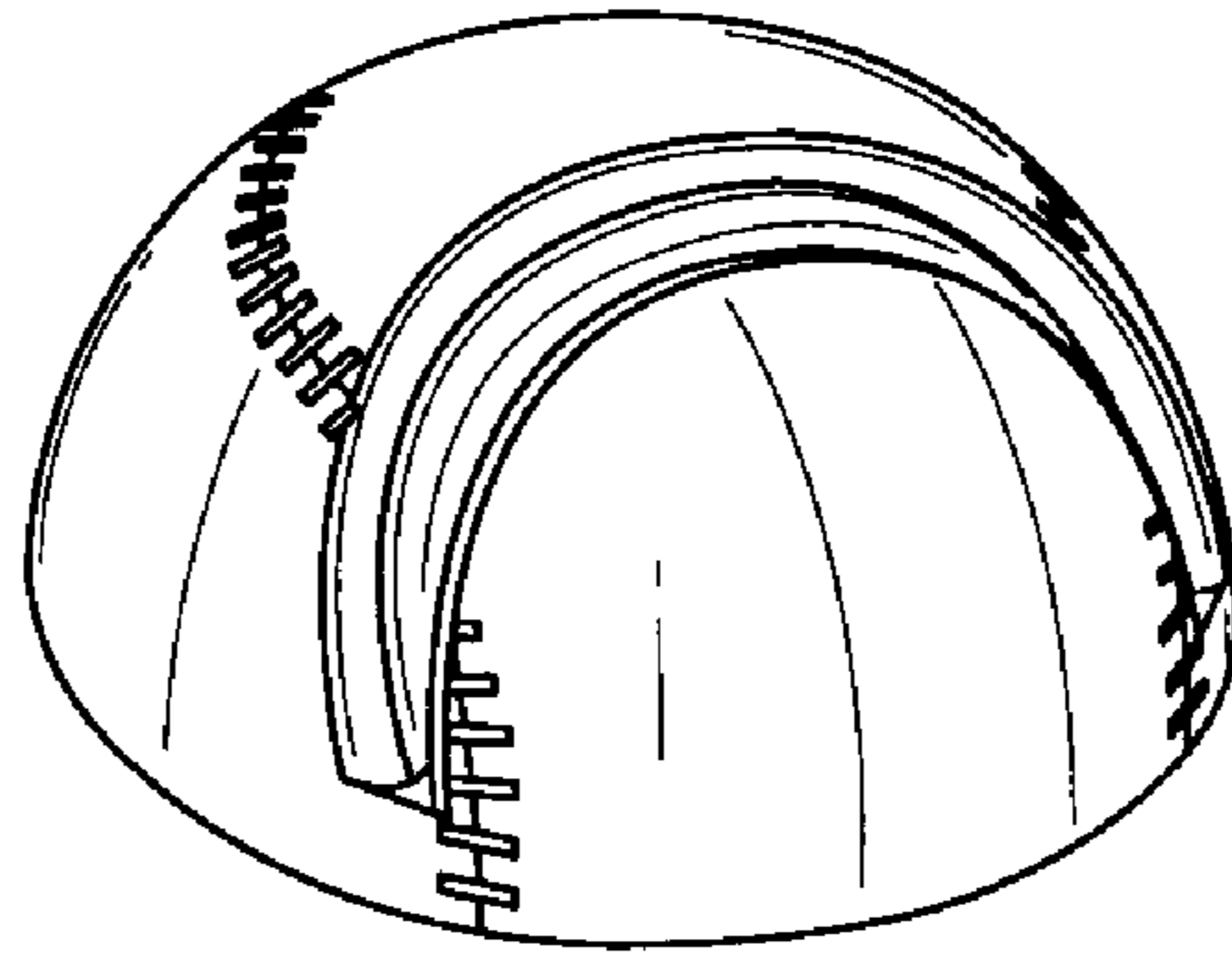

FIG. 29

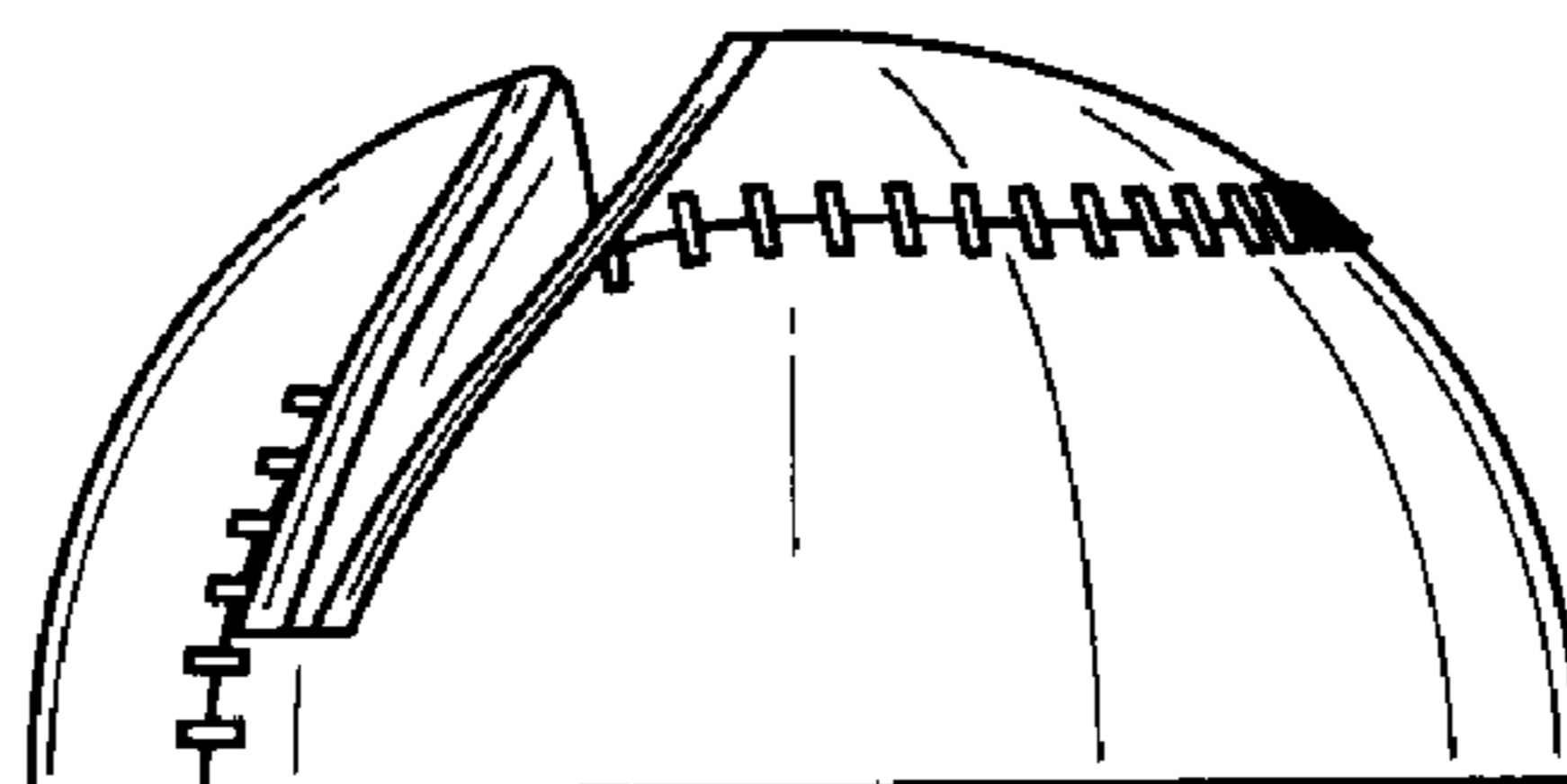

FIG. 30

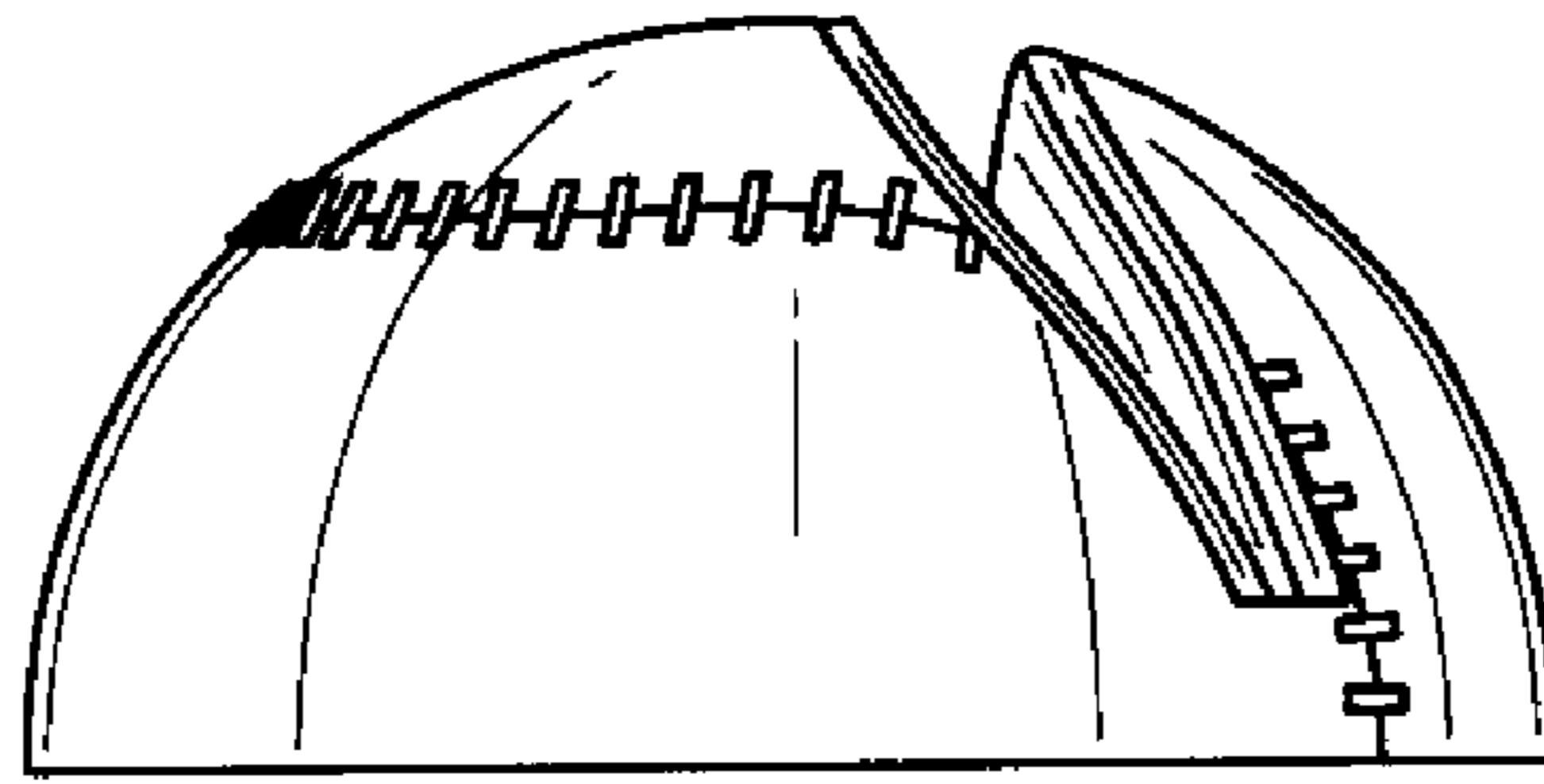

FIG. 31

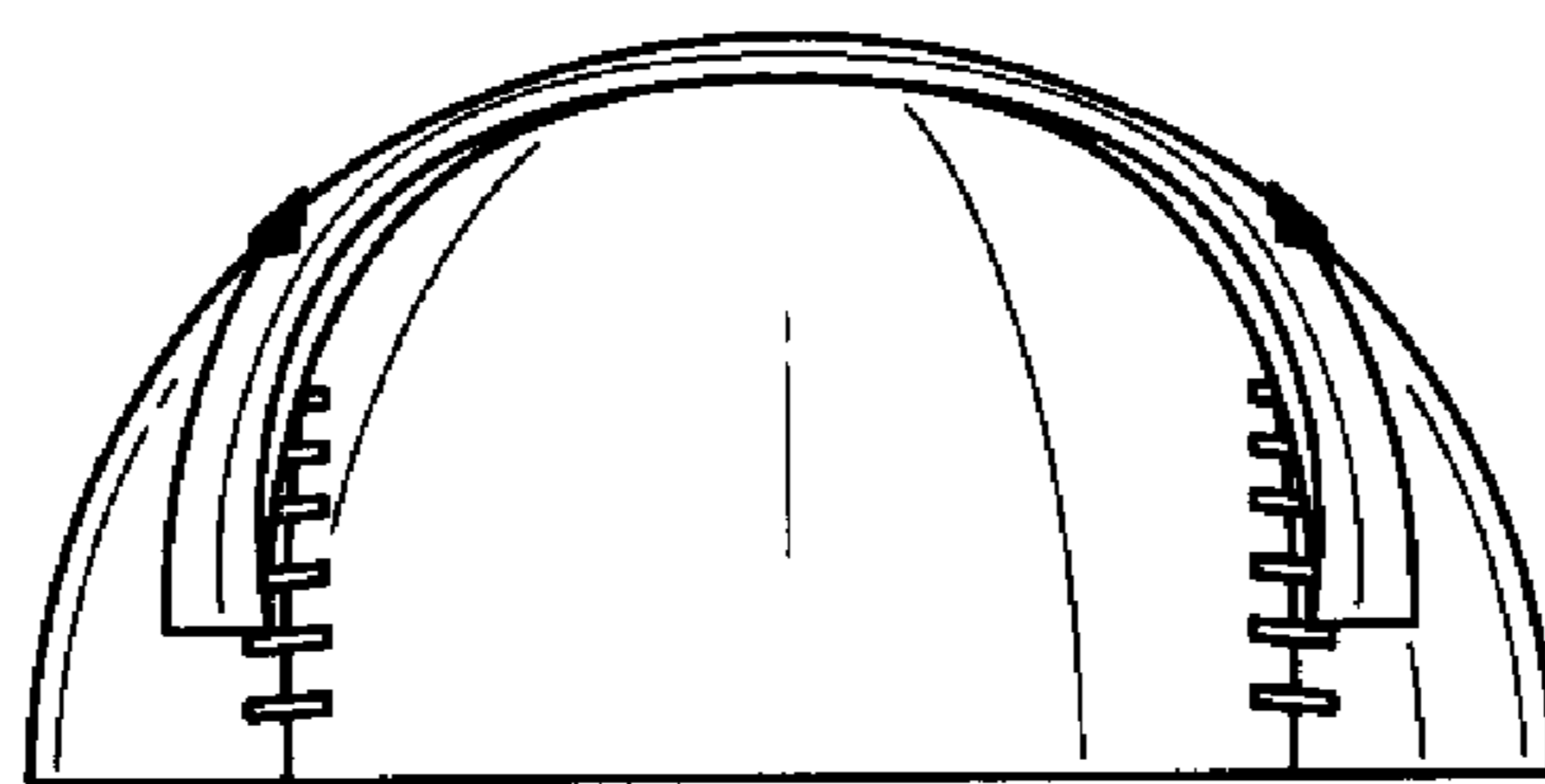

FIG. 32

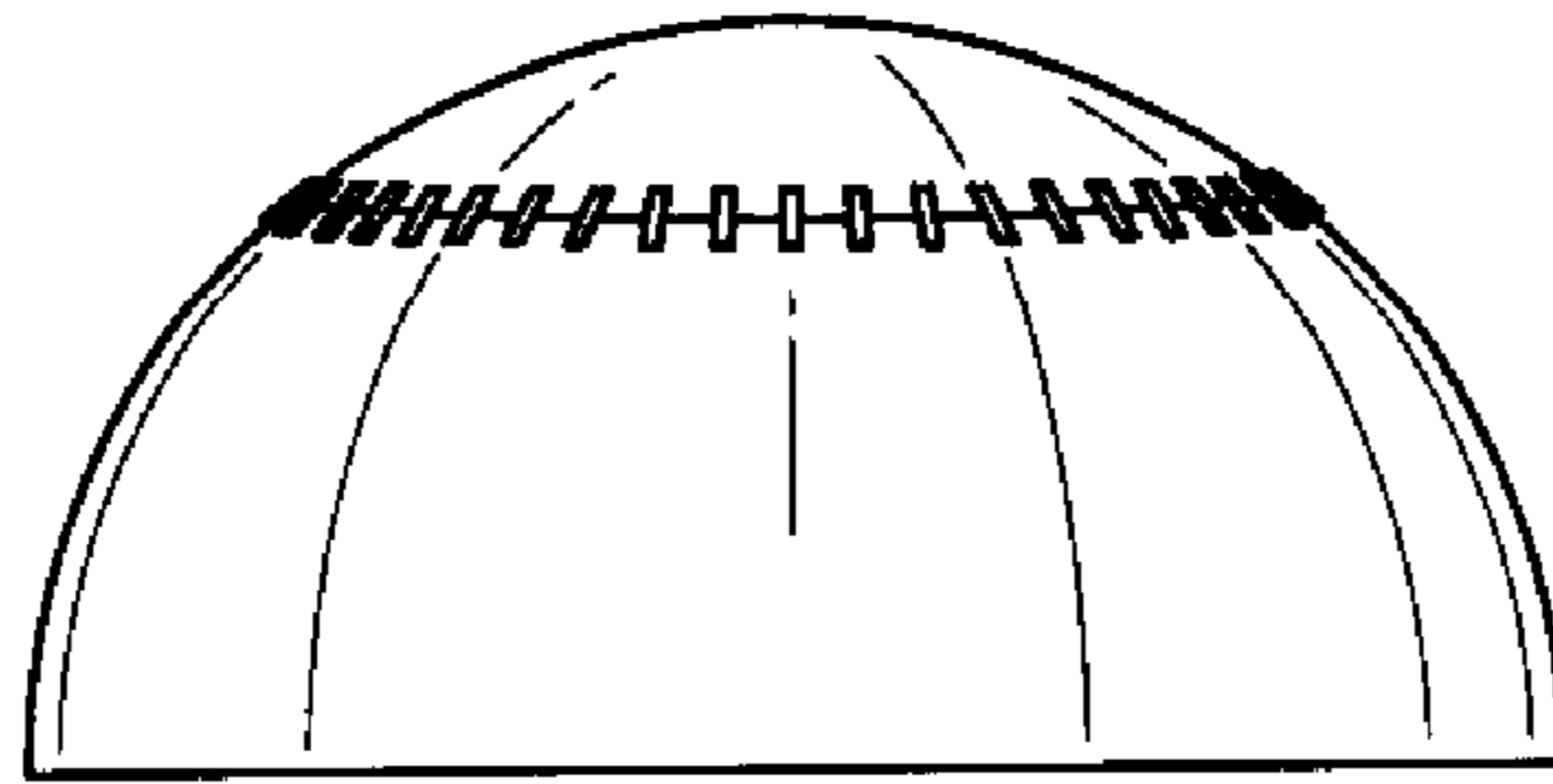

FIG. 33

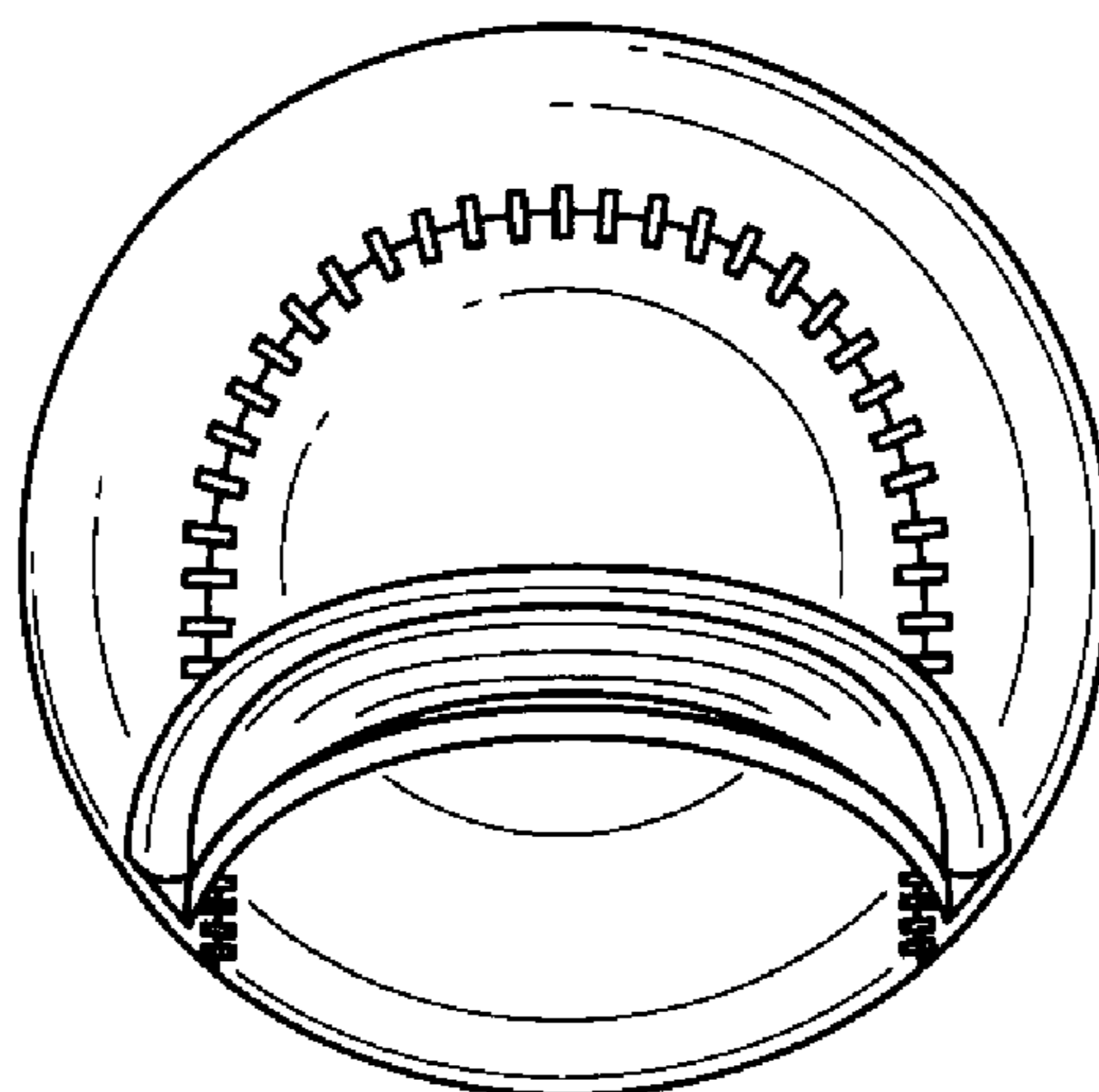

FIG. 34

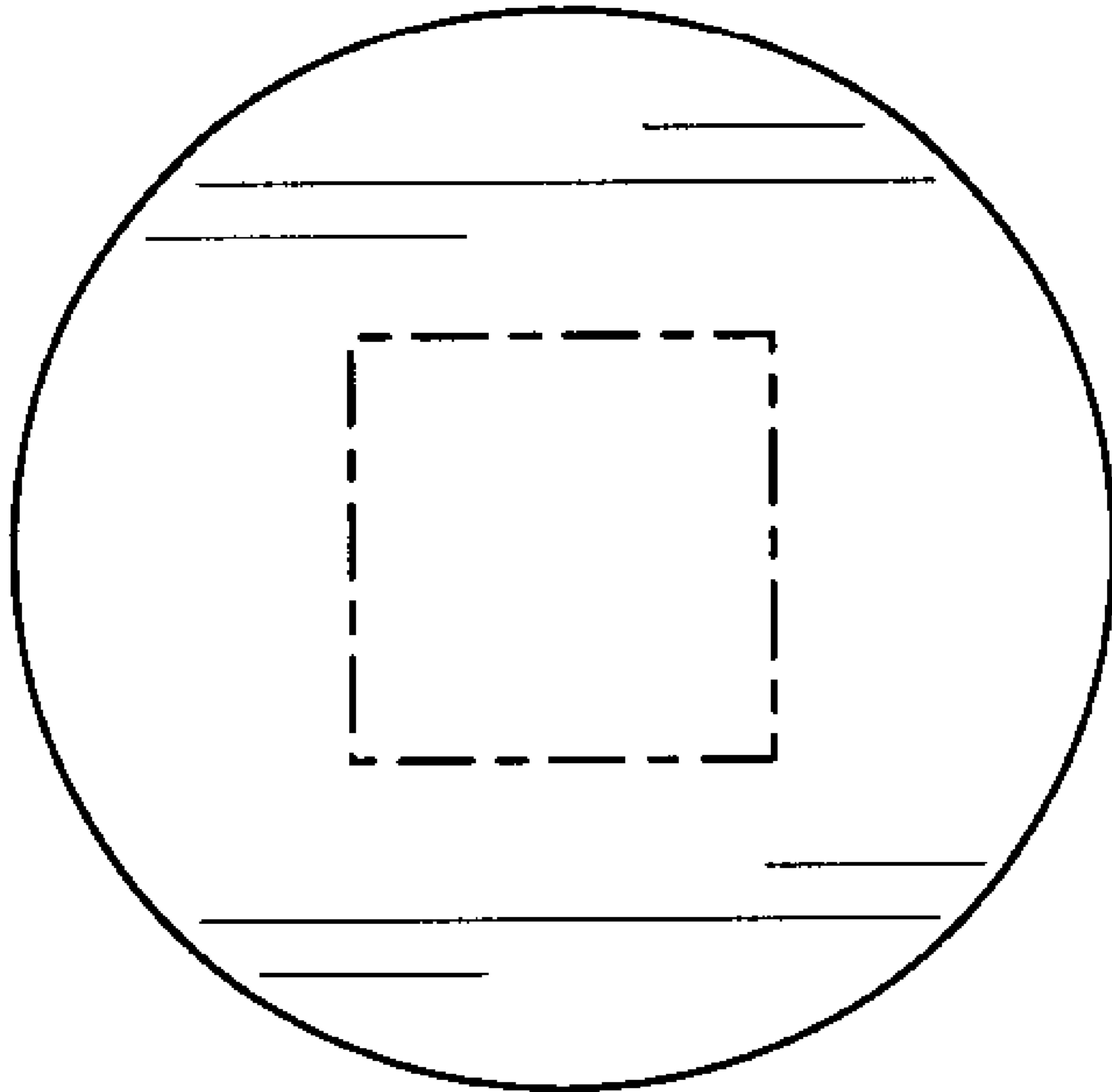

FIG. 35