

US00D507294S

(12) **United States Design Patent**
Kida et al.

(10) **Patent No.: US D507,294 S**
(45) **Date of Patent: ** Jul. 12, 2005**

(54) **STAMP**

(75) Inventors: **Masaki Kida**, Setagaya-ku (JP);
Motohide Imaizumi, Setagaya-ku (JP)

(73) Assignee: **Shachihata Inc.**, Aichi (JP)

(**) Term: **14 Years**

(21) Appl. No.: **29/209,586**

(22) Filed: **Jul. 19, 2004**

(30) **Foreign Application Priority Data**

Jan. 21, 2004 (JP) D2004-001346

(51) **LOC (8) Cl.** **19-02**

(52) **U.S. Cl.** **D18/15**

(58) **Field of Search** D18/15-18, 50;
101/333-334, 327, 405, 406, 328, 352.07;
118/264, 268

(56) **References Cited**

U.S. PATENT DOCUMENTS

675,818 A *	6/1901	Crabb	118/268
4,289,070 A *	9/1981	MacGregor	101/327
D376,383 S *	12/1996	Harden	D18/15
D385,905 S *	11/1997	Harden	D18/15
D412,181 S *	7/1999	Harden	D18/15
D417,232 S *	11/1999	Harden	D18/15
D444,808 S *	7/2001	Dour et al.	D18/15
6,367,382 B1 *	4/2002	Imamaki et al.	101/405
D497,936 S *	11/2004	Kida et al.	D18/15

FOREIGN PATENT DOCUMENTS

GB	2096026	* 11/2000
GB	2096946	* 11/2000

* cited by examiner

Primary Examiner—Charles A. Rademaker
(74) *Attorney, Agent, or Firm*—Jacobson Holman PLLC

(57) **CLAIM**

The ornamental design for a stamp, as shown and described.

DESCRIPTION

FIG. 1 is a front elevation of a stamp showing our new design;

FIG. 2 is a rear elevation thereof;

FIG. 3 is a right side elevation thereof;

FIG. 4 is a left side elevation thereof;

FIG. 5 is a top plan elevation thereof;

FIG. 6 is a bottom plan view thereof;

FIG. 7 is a cross-sectional view taken along line A—A in FIG. 1;

FIG. 8 is a cross-sectional view taken along line B—B in FIG. 3;

FIG. 9 is a front elevation of the stamp body with the cap omitted for ease of illustration;

FIG. 10 is a rear elevation thereof;

FIG. 11 is a right side elevation thereof;

FIG. 12 is a left side elevation thereof;

FIG. 13 is a top plan view thereof;

FIG. 14 is a bottom plan view thereof;

FIG. 15 is a front elevation of the cap member with the stamp body omitted for ease of illustration;

FIG. 16 is a rear elevation thereof;

FIG. 17 is a right side elevation thereof;

FIG. 18 is a left side elevation thereof;

FIG. 19 is a top plan view thereof; and,

FIG. 20 is a bottom plan view thereof.

1 Claim, 5 Drawing Sheets

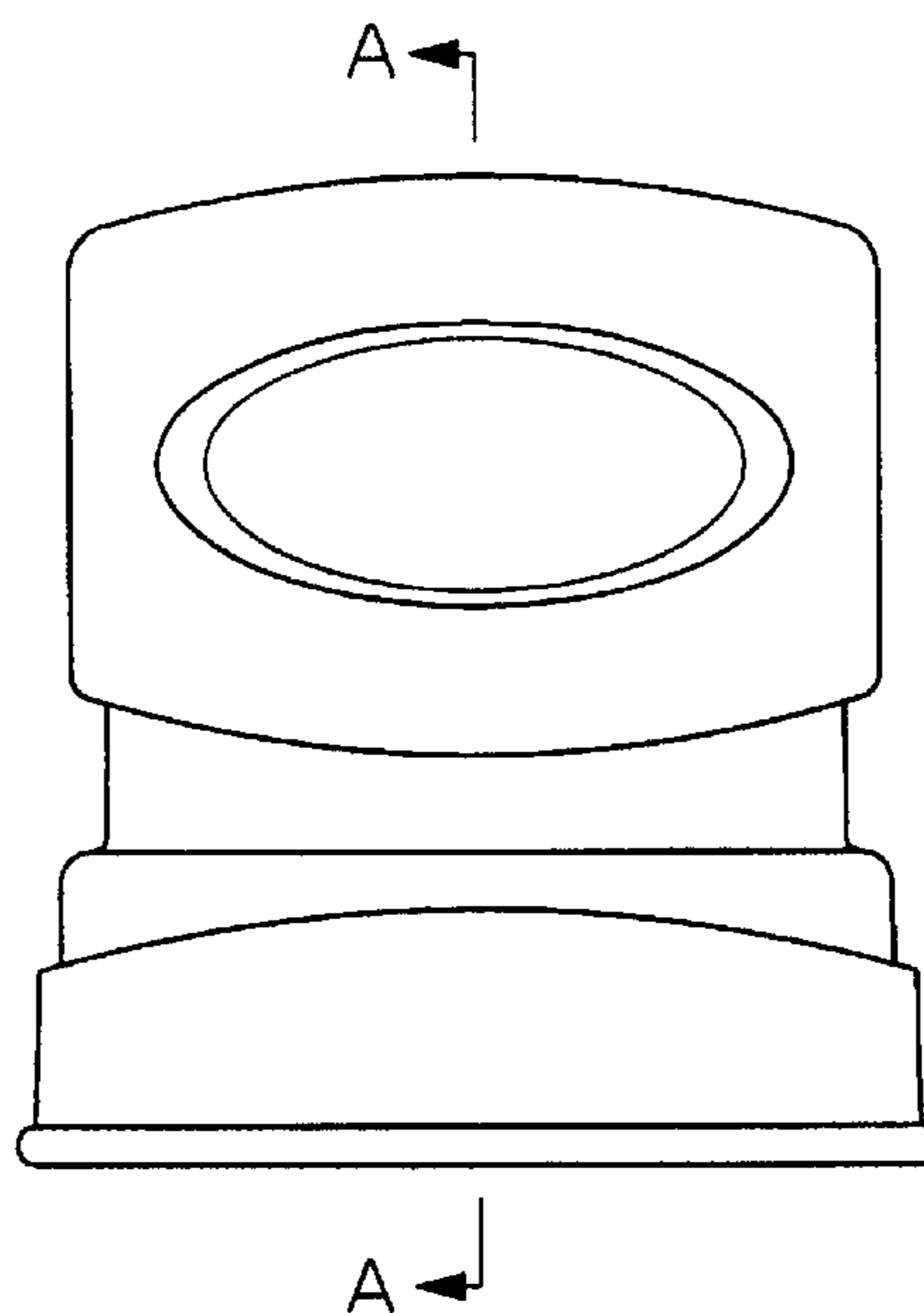

FIG.1

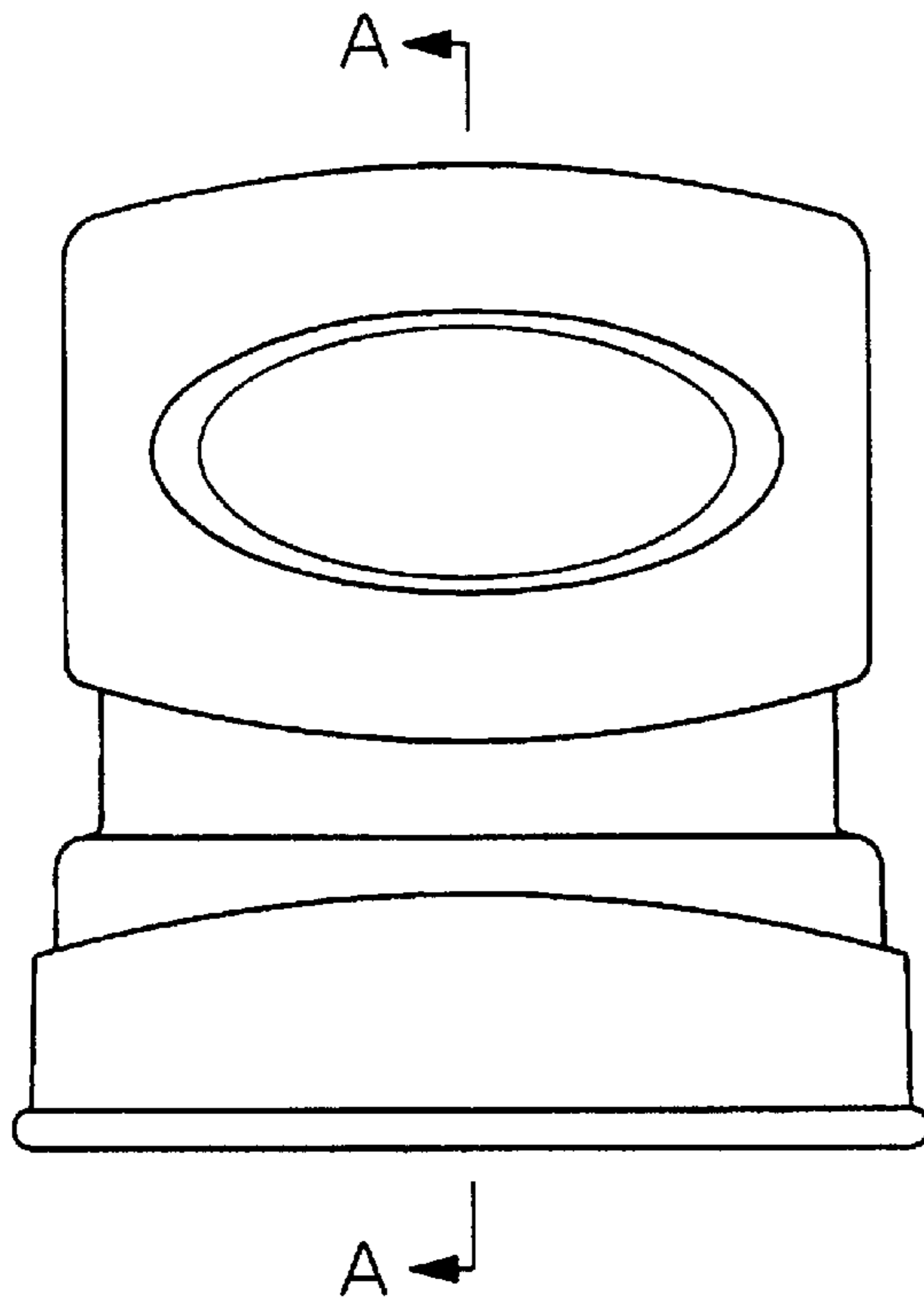

FIG.3

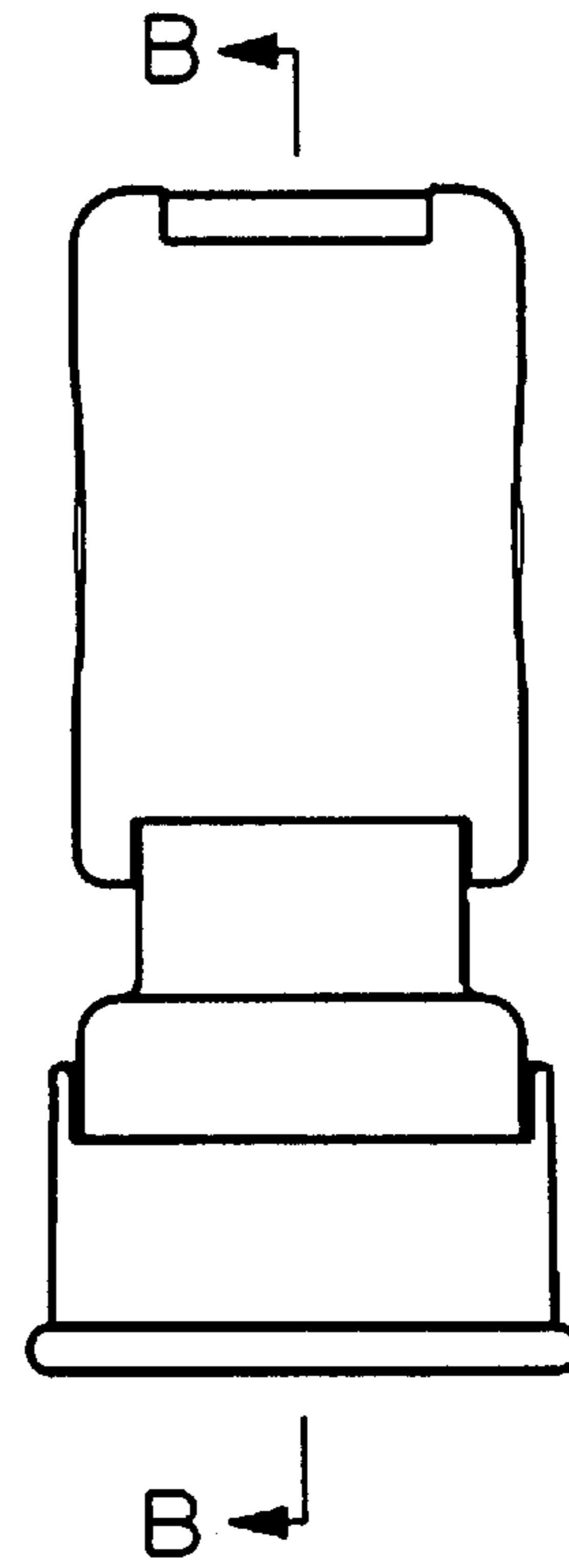

FIG.2

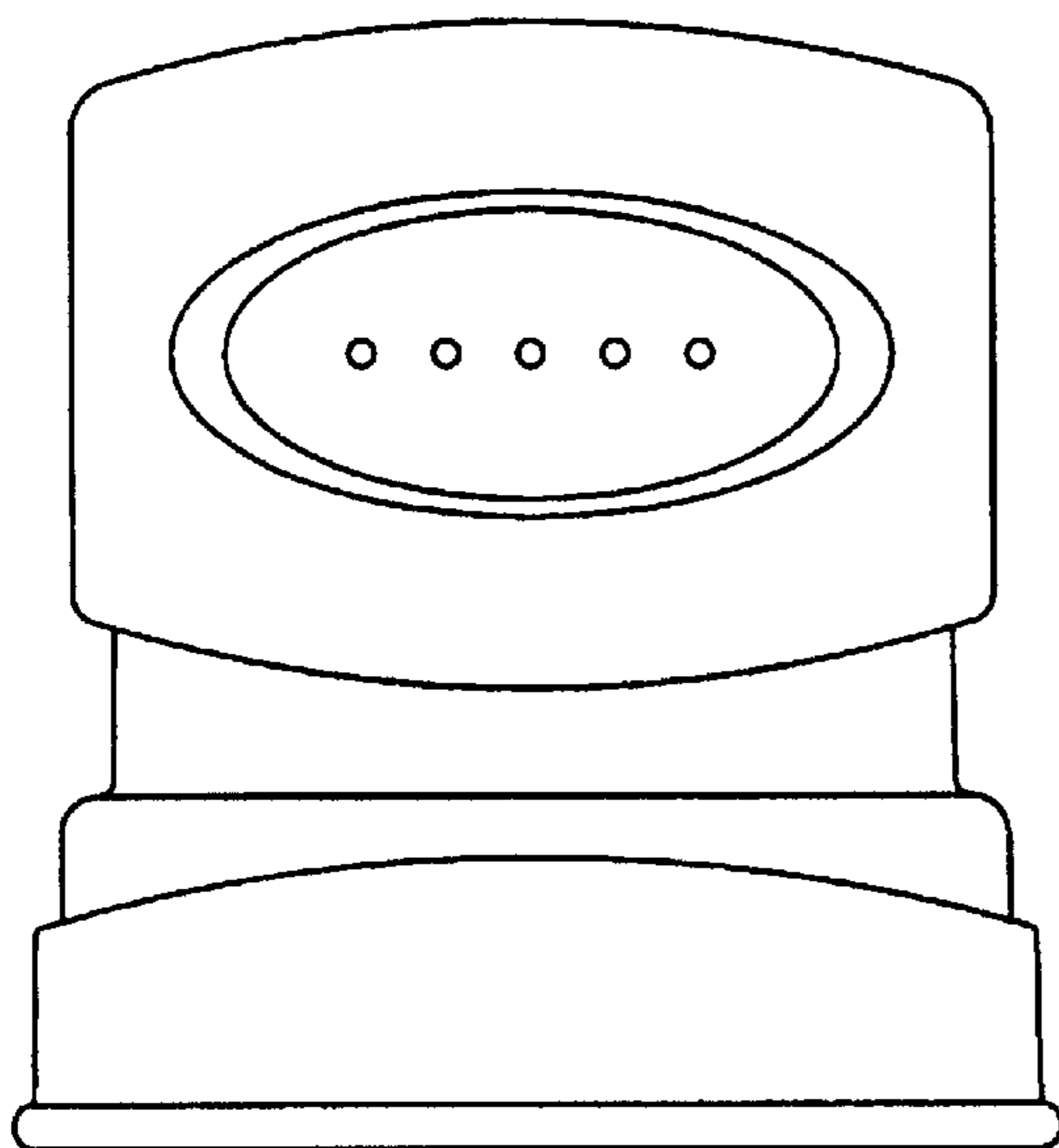

FIG.4

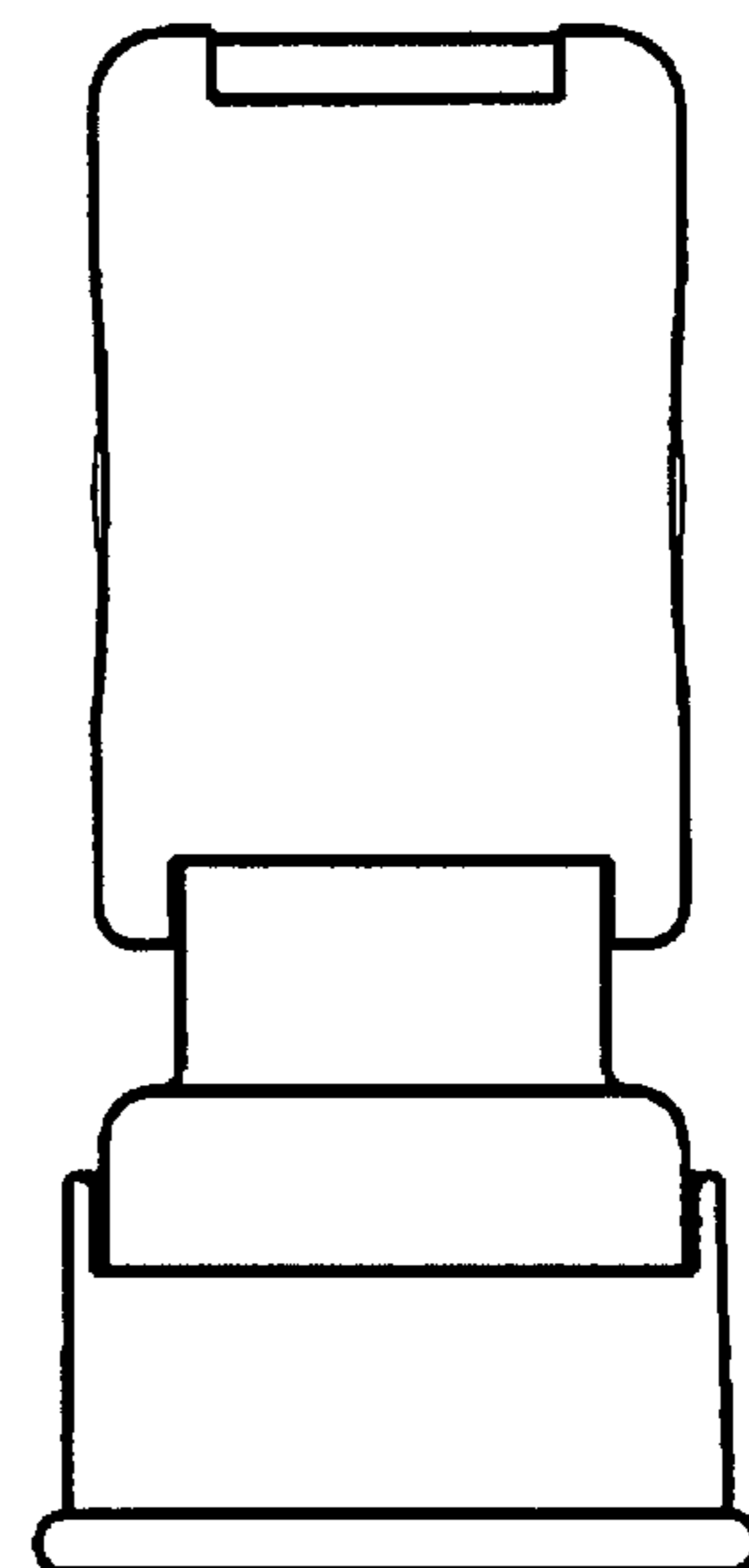

FIG.5

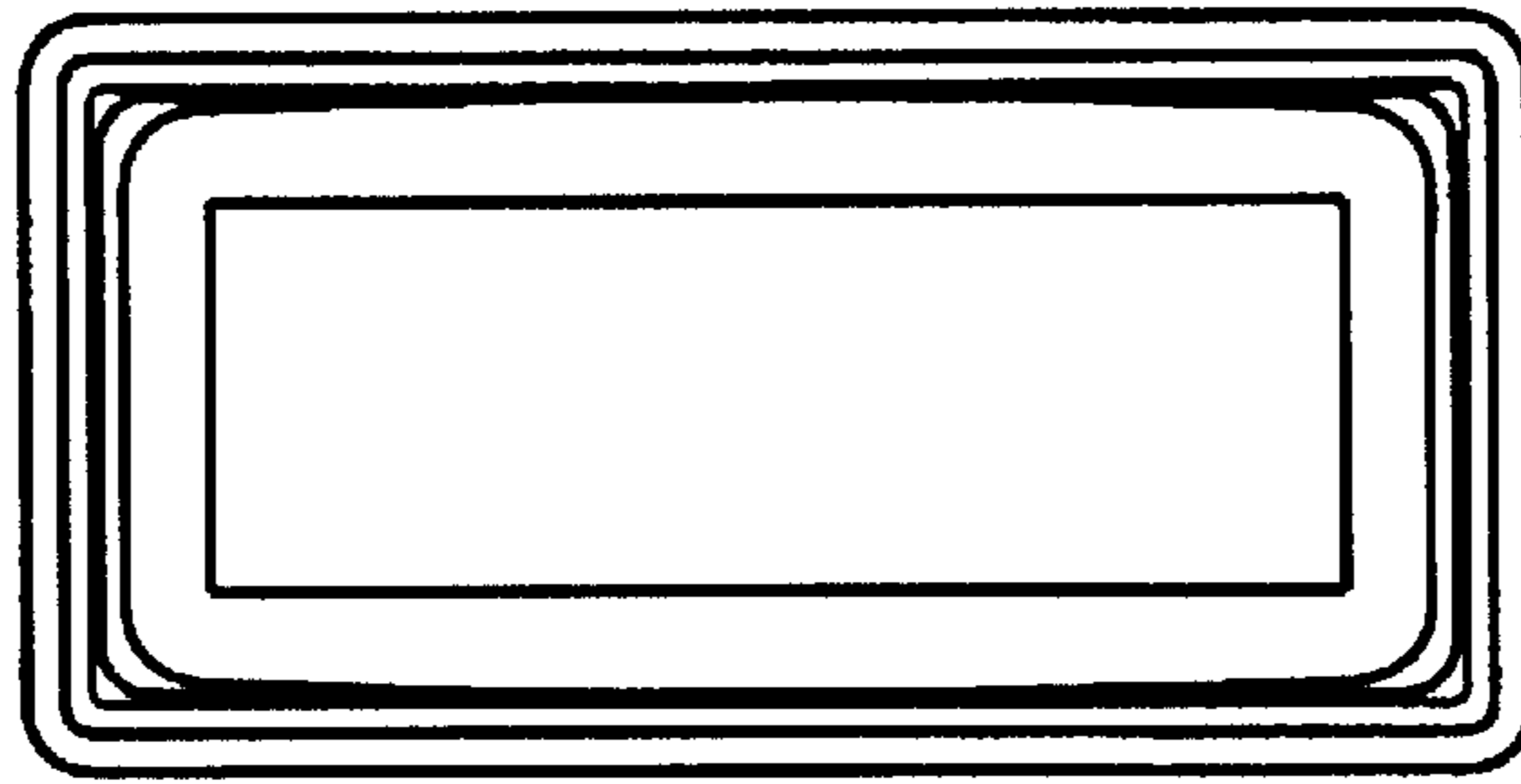

FIG.6

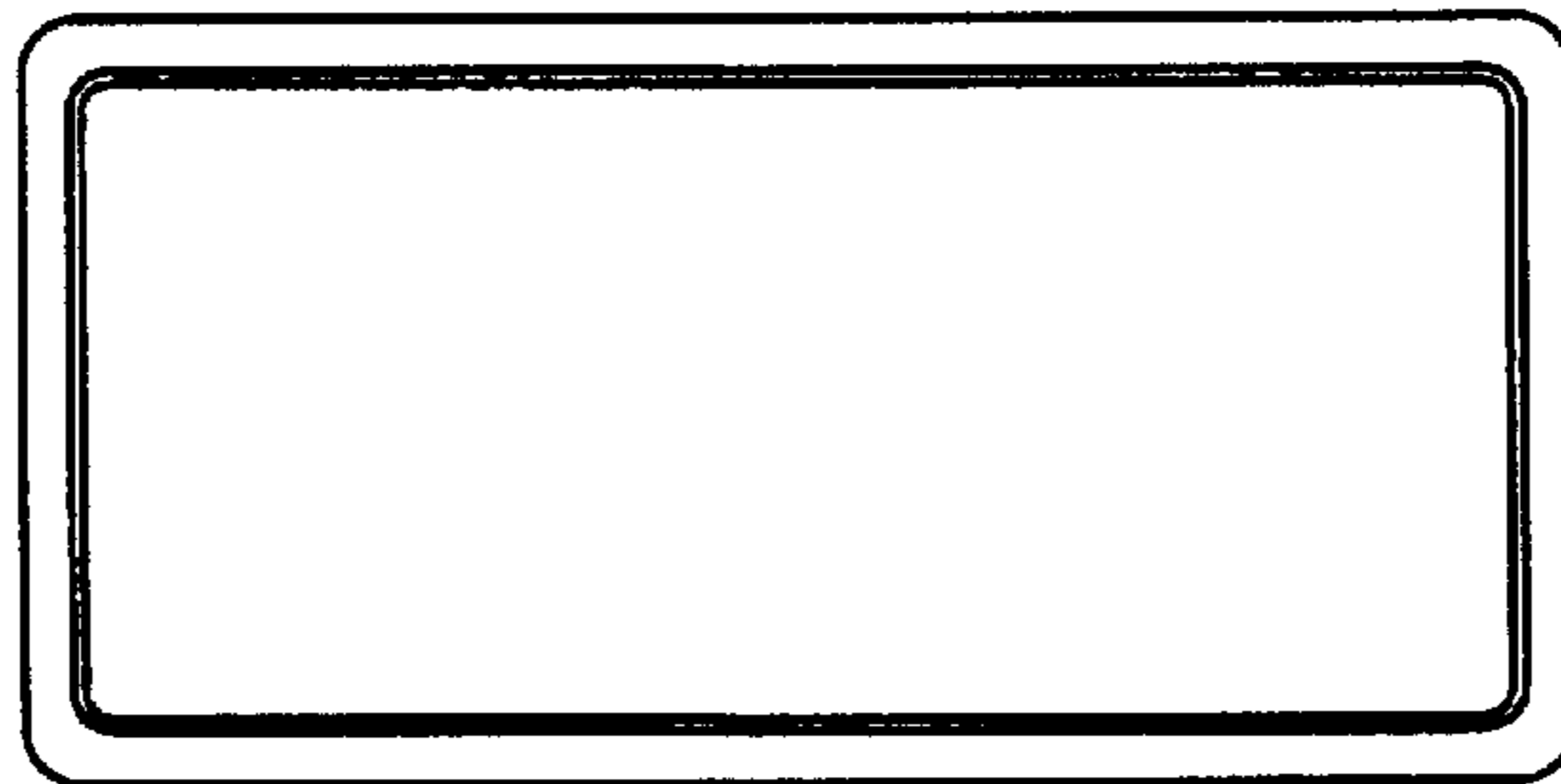

FIG.7

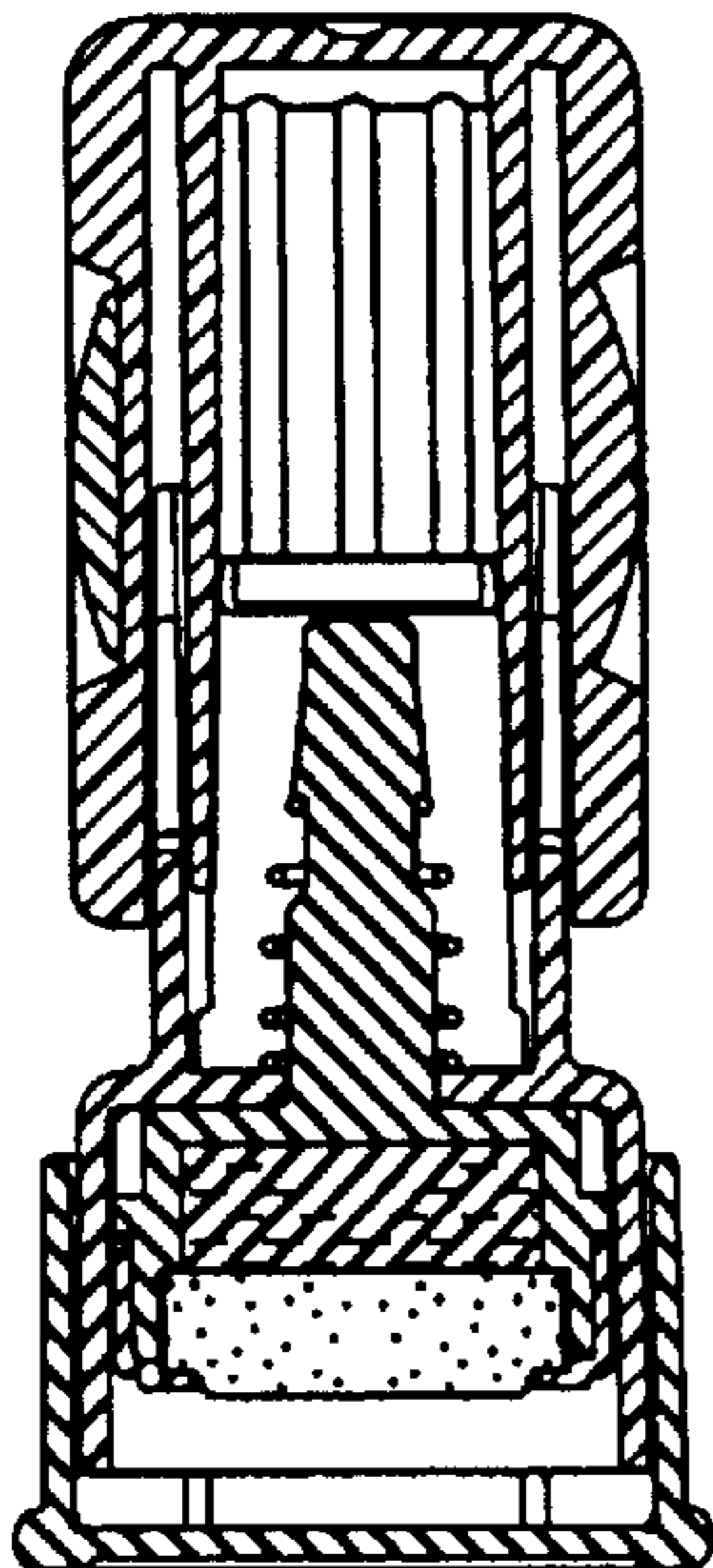

FIG.8

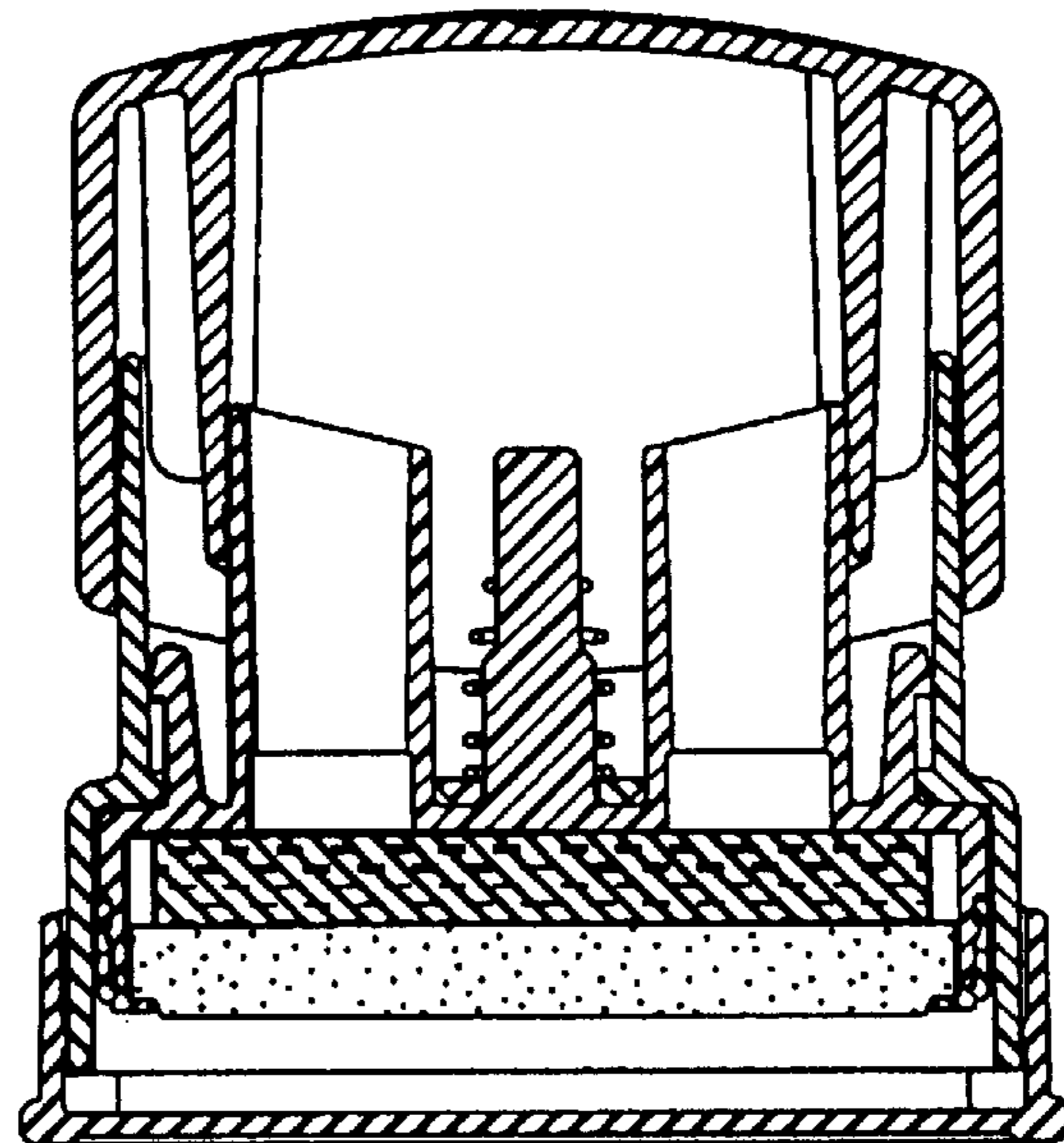

FIG.9

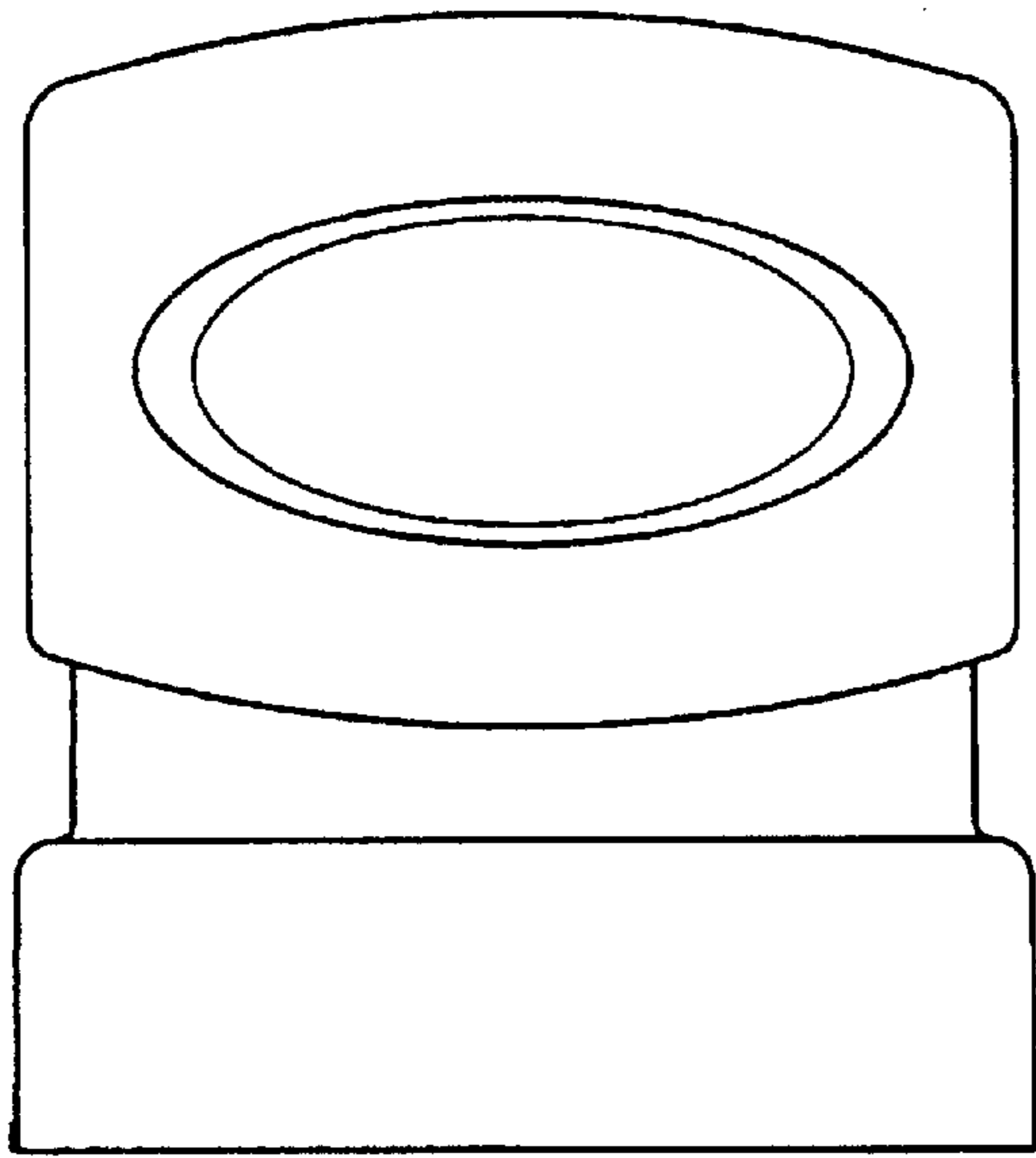

FIG.11

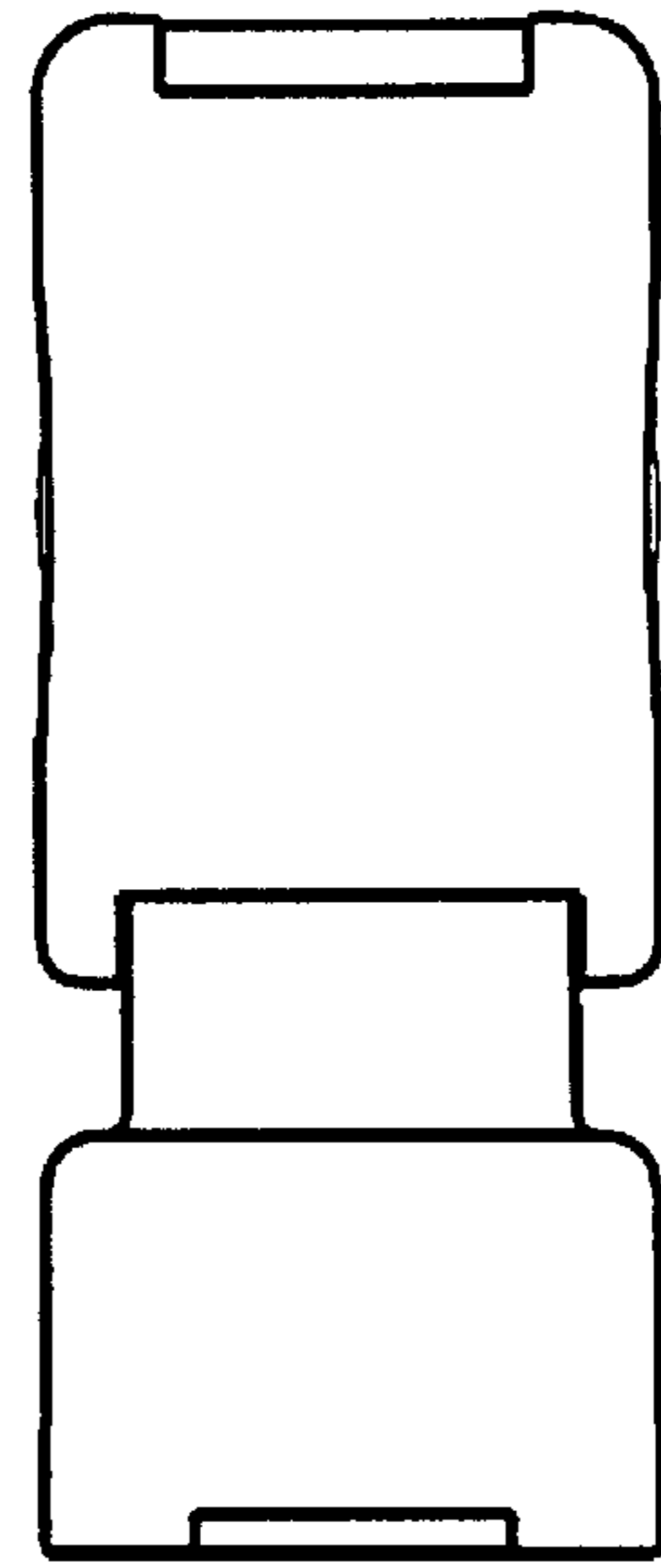

FIG.10

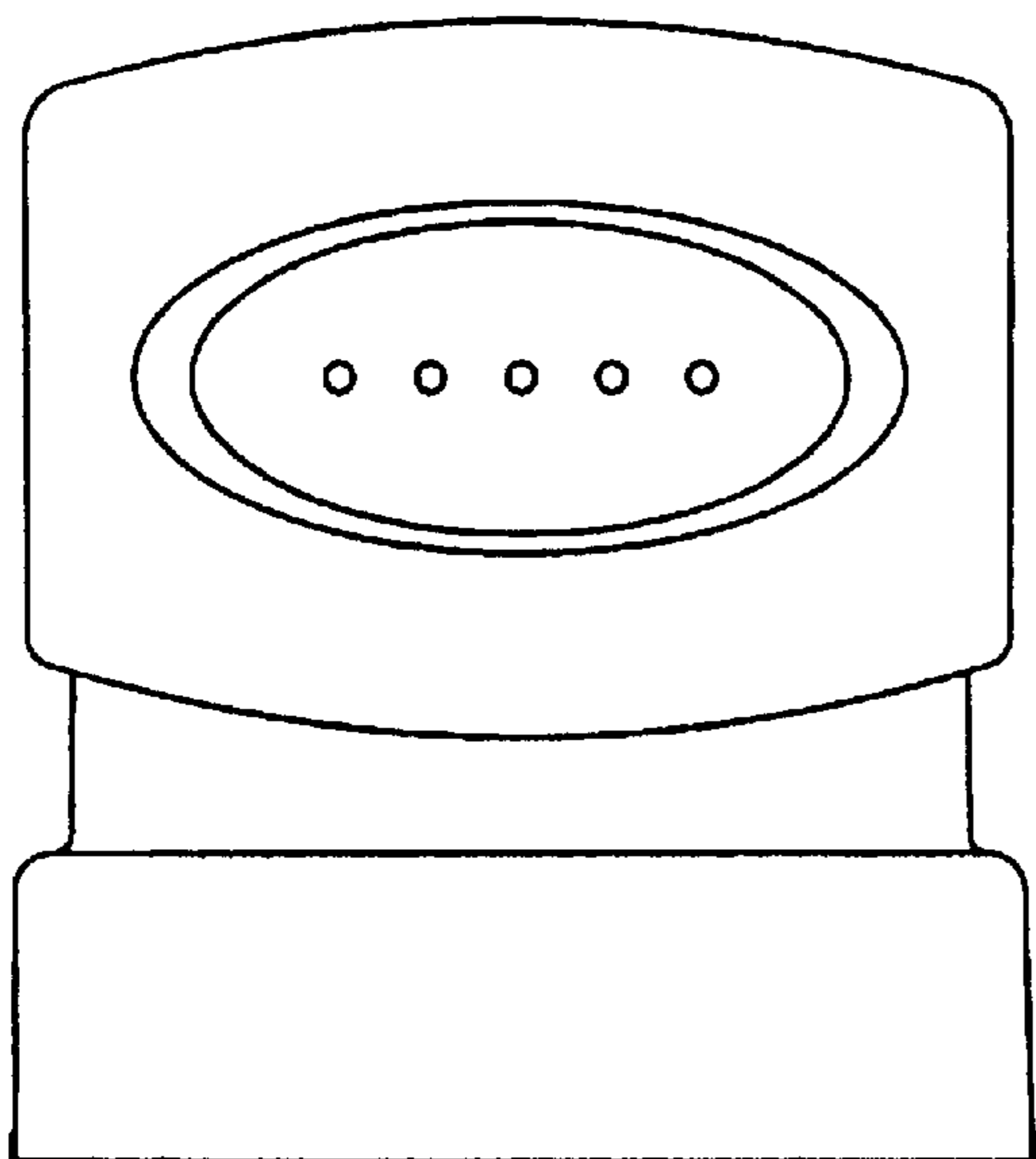

FIG.12

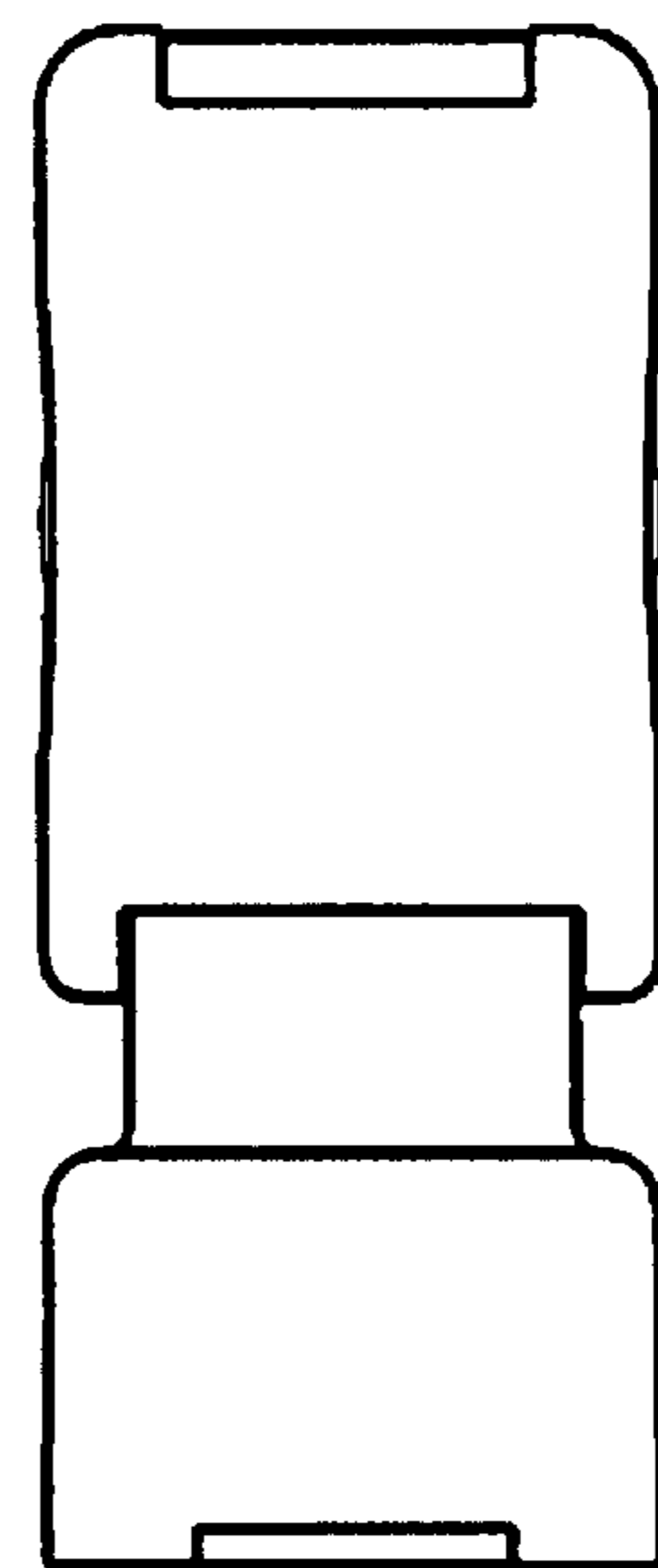

FIG.13

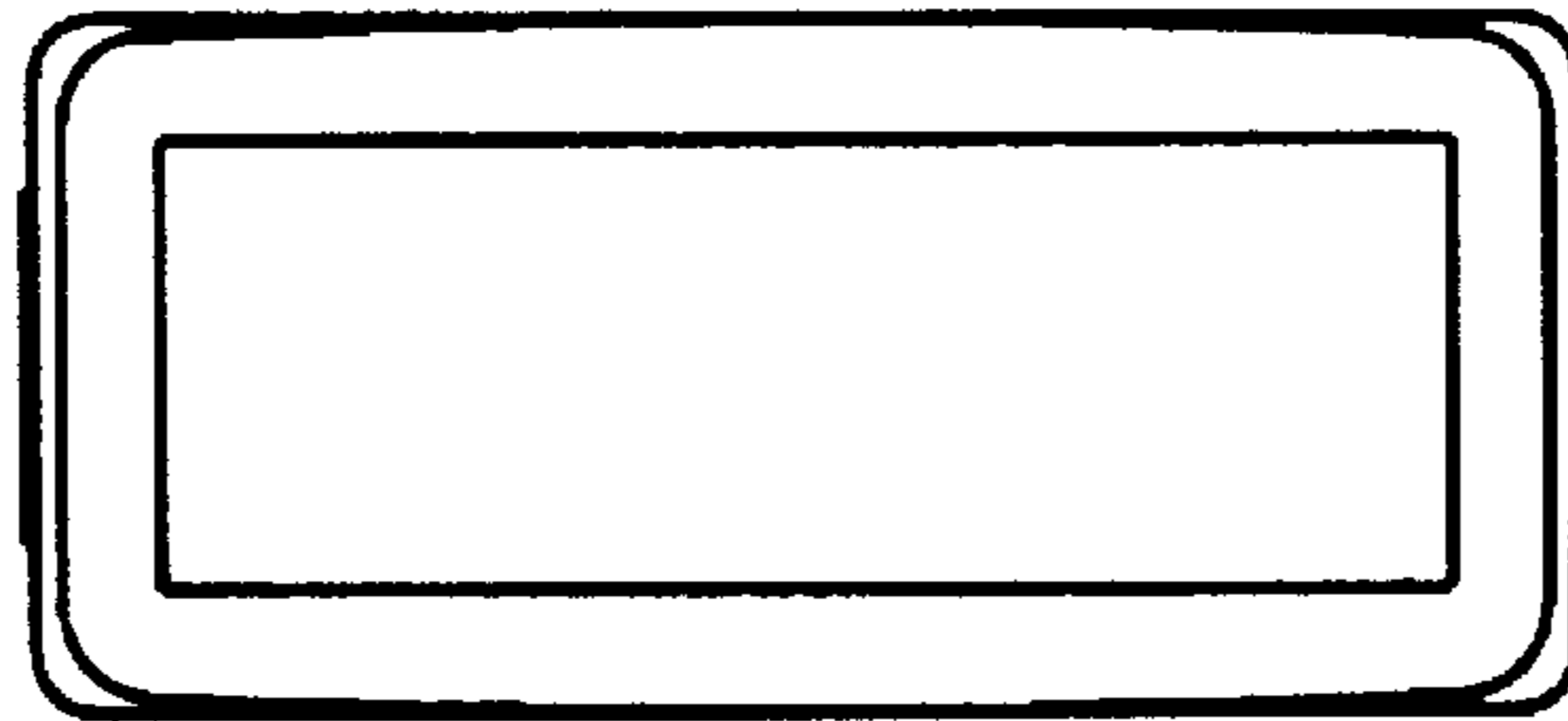

FIG.14

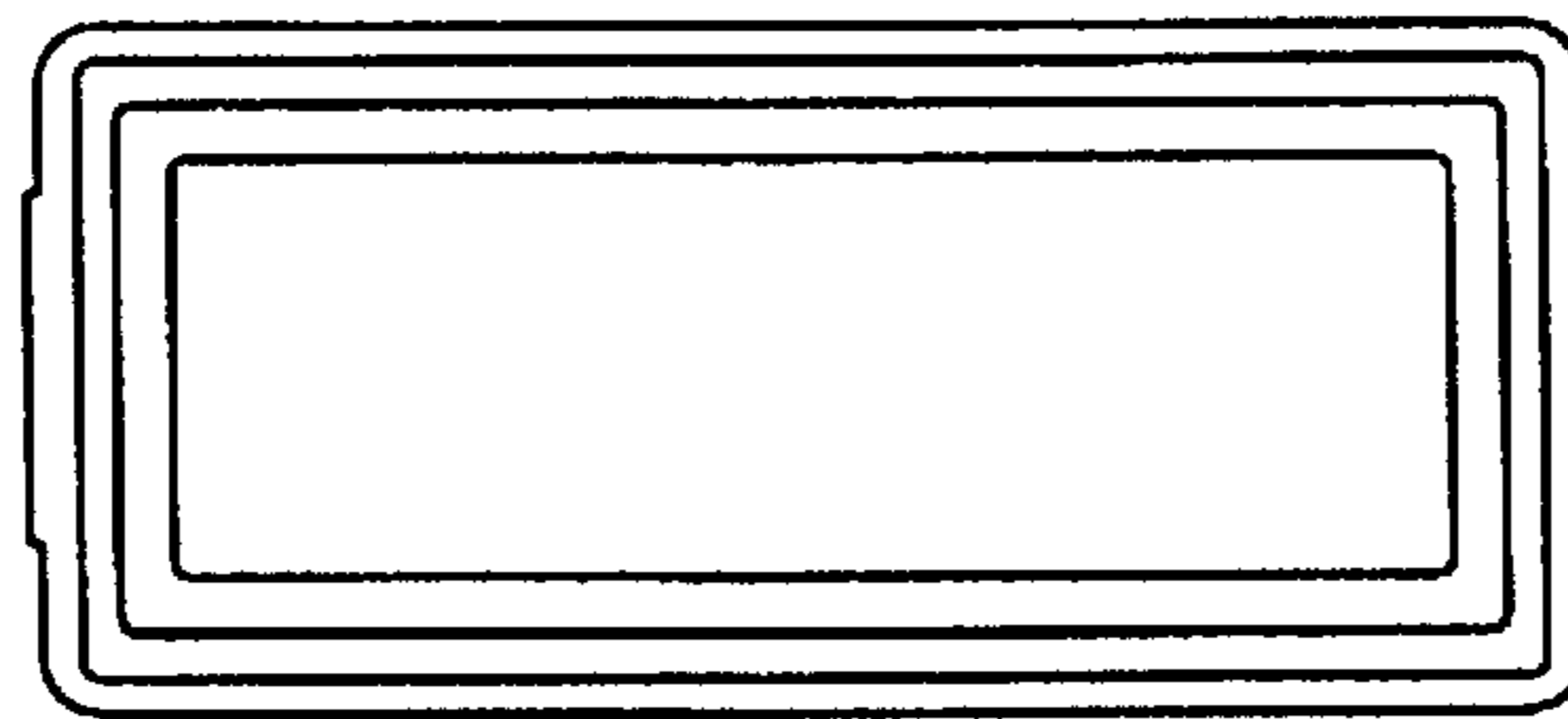

FIG.15

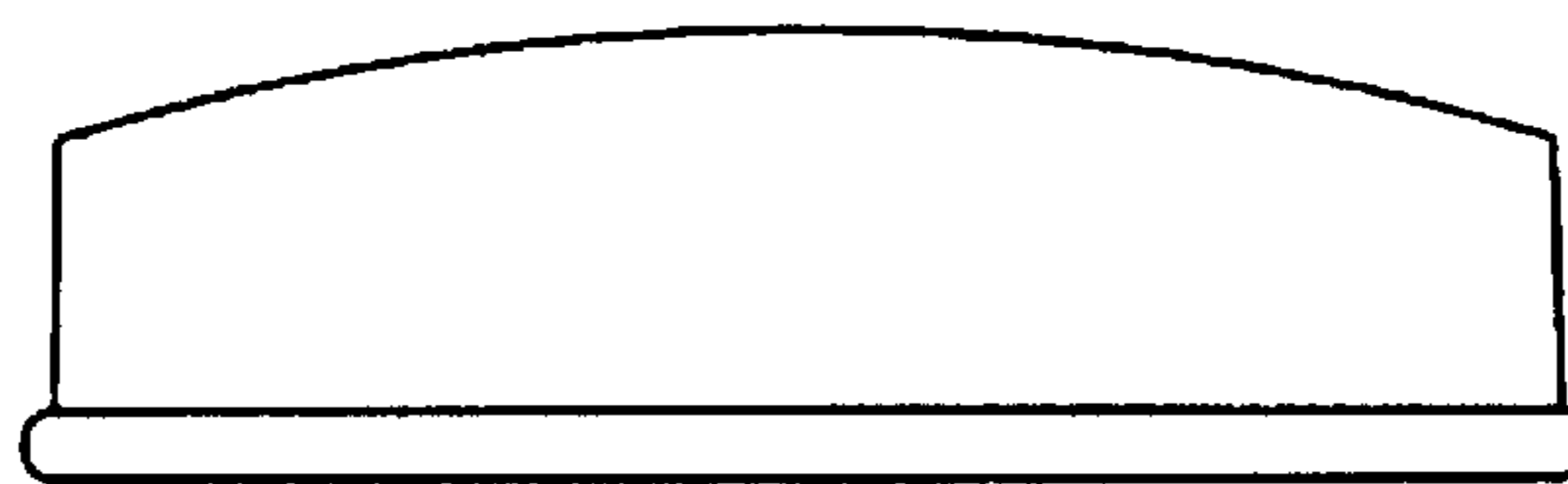

FIG.16

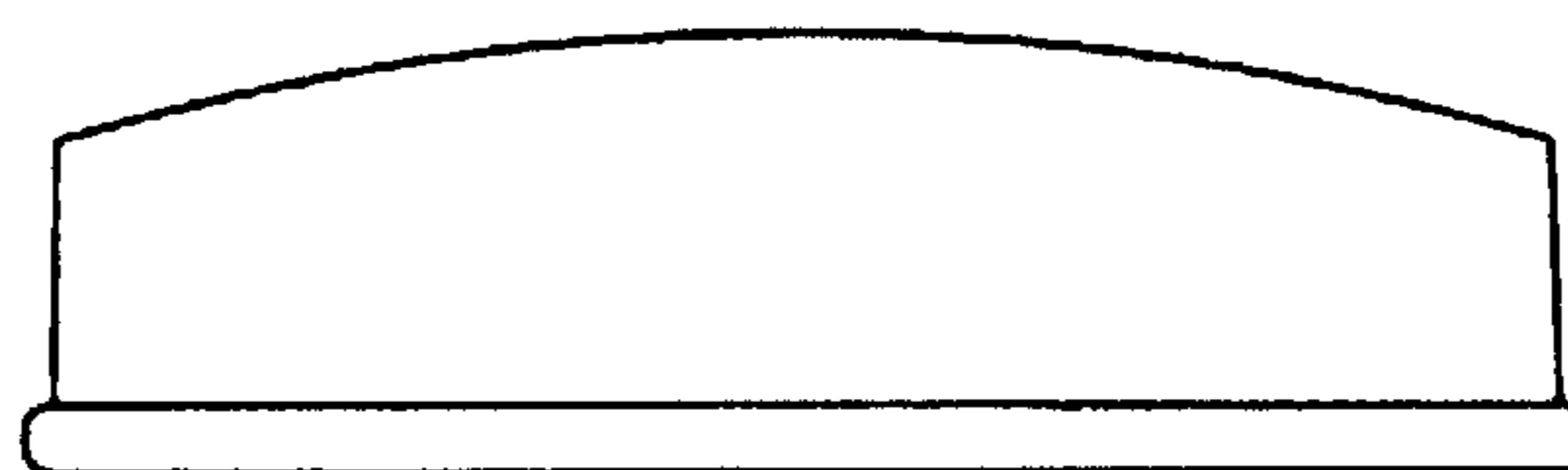

FIG.17

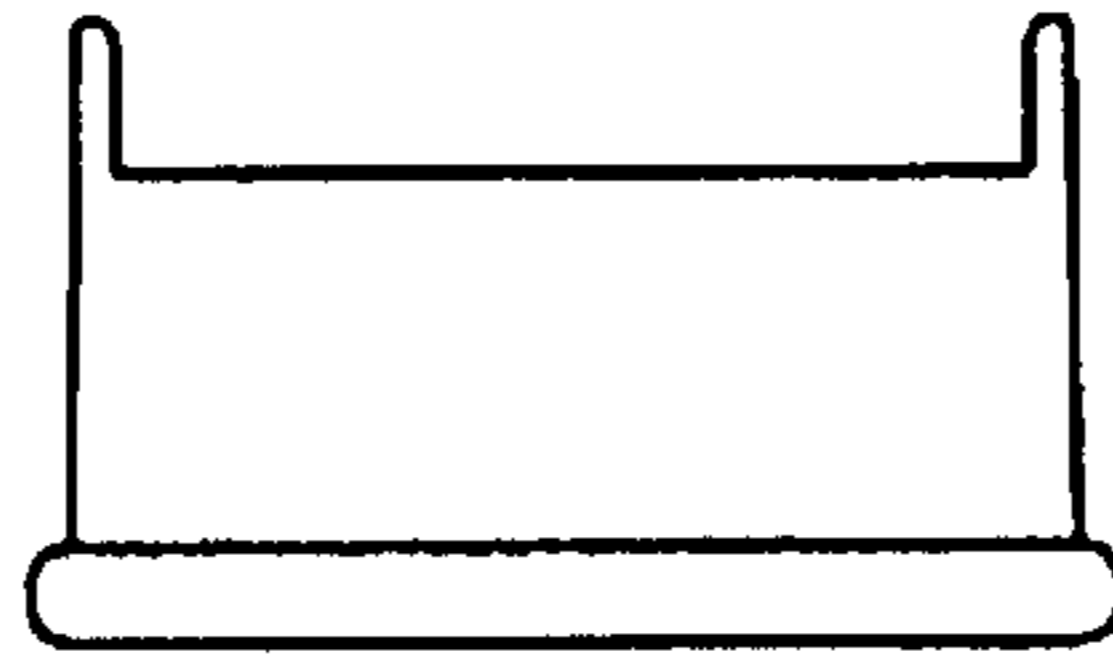

FIG.18

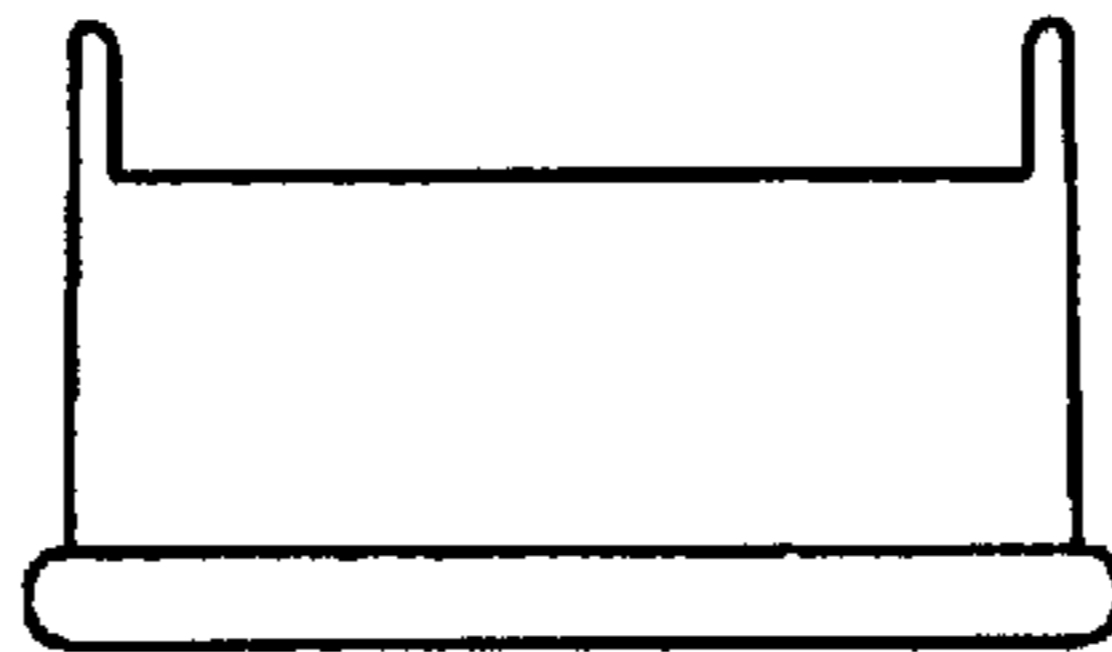

FIG.19

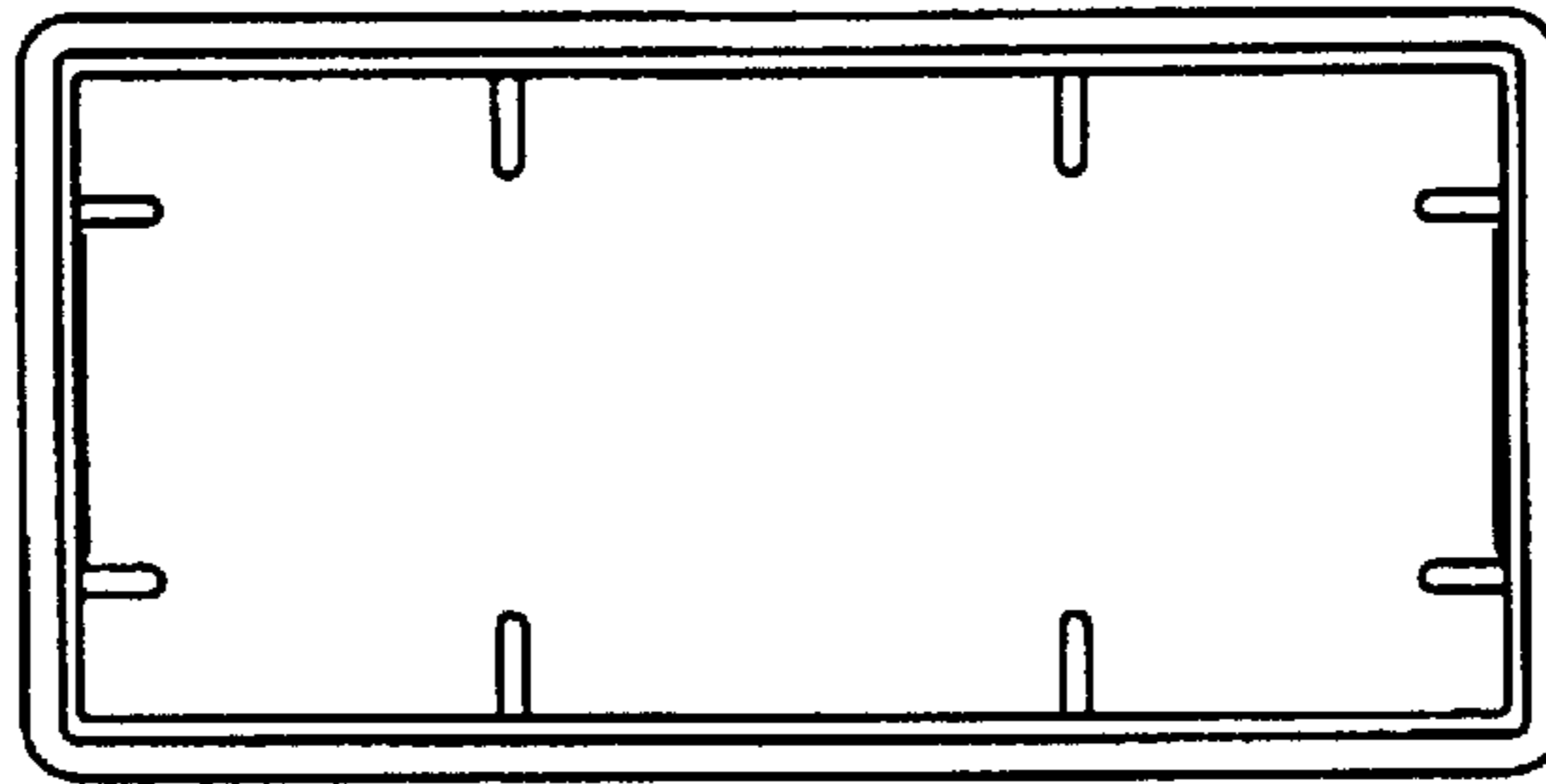

FIG.20

