



US00D507121S

(12) **United States Design Patent**
Eyman et al.

(10) **Patent No.: US D507,121 S**
(45) **Date of Patent: ** Jul. 12, 2005**

(54) **BABY BOUNCER**

(76) Inventors: **David W. Eyman**, 2134 Alpine Pl., Cincinnati, OH (US) 45206; **Thomas J. Schmidlin**, 1331 Morten St., Cincinnati, OH (US) 45208

(**) Term: **14 Years**

(21) Appl. No.: **29/216,761**

(22) Filed: **Nov. 9, 2004**

Related U.S. Application Data

(62) Division of application No. 29/195,604, filed on Dec. 15, 2003.

(51) **LOC (8) Cl.** **06-01**

(52) **U.S. Cl.** **D6/344**

(58) **Field of Search** D6/333-335, 344, D6/348, 365, 367, 368, 371-376, 500-502; D21/412; 297/55, 56, 250.1, 258.1, 271.5, 271.6, 285, 294, 440.11, 440.24, 451.4, 452.11, 452.12, DIG. 11, 45

(56) **References Cited**

U.S. PATENT DOCUMENTS

2,723,712 A	*	11/1955	Yellen	297/440.11
D183,743 S	*	10/1958	Howell, Jr.	D6/334
2,930,430 A	*	3/1960	Bloom	297/271.6
3,180,685 A	*	4/1965	Rogalski et al.	297/440.24
D213,870 S	*	4/1969	Hamilton, II	D6/333
3,656,808 A	*	4/1972	Chang	297/451.4
6,332,646 B1	*	12/2001	Tseng	297/16.1

6,447,057 B1	*	9/2002	Chen	297/16.2
D475,860 S	*	6/2003	Yang	D6/367
6,702,371 B2	*	3/2004	Zheng	297/45
2003/0234561 A1	*	12/2003	Zheng	297/45

* cited by examiner

Primary Examiner—Mimosa De
(74) *Attorney, Agent, or Firm*—Wood, Herron & Evans, L.L.P.

(57) **CLAIM**

The ornamental design for a baby bouncer, as shown and described.

DESCRIPTION

FIG. 1 is a perspective view of a baby bouncer showing one embodiment of our design;
FIG. 2 is a front elevational view thereof;
FIG. 3 is a right side elevational view thereof;
FIG. 4 is a rear elevational view thereof;
FIG. 5 is a left side elevational view thereof.
FIG. 6 is a top plan view thereof;
FIG. 7 is a bottom plan view thereof;
FIG. 8 is a perspective view of a baby bouncer showing an alternative embodiment of our design;
FIG. 9 is a front elevational view thereof;
FIG. 10 is a right side elevational view thereof;
FIG. 11 is a rear elevational view thereof;
FIG. 12 is a left side elevational view thereof.
FIG. 13 is a top plan view thereof; and,
FIG. 14 is a bottom plan view thereof.

1 Claim, 8 Drawing Sheets

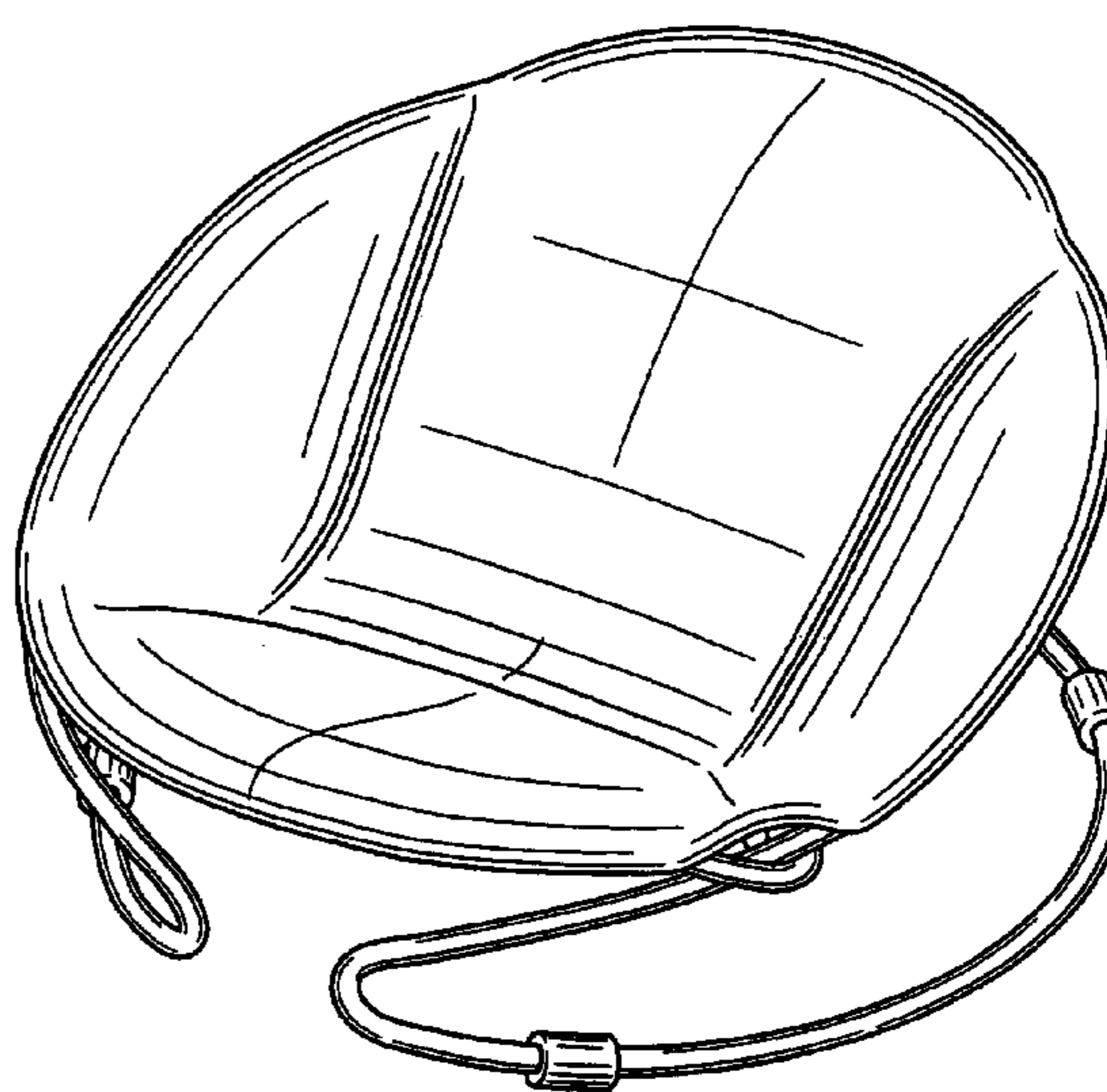
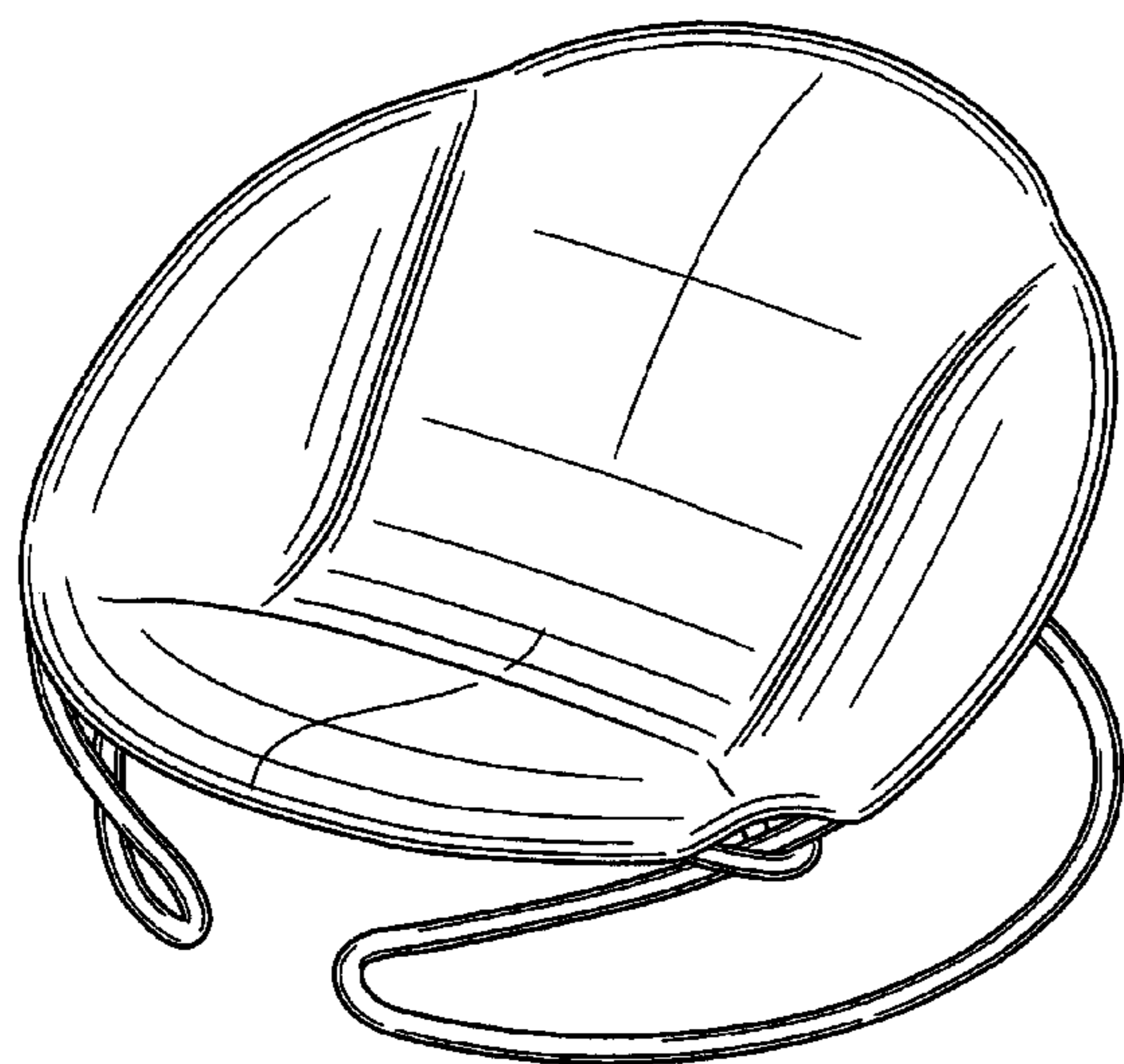

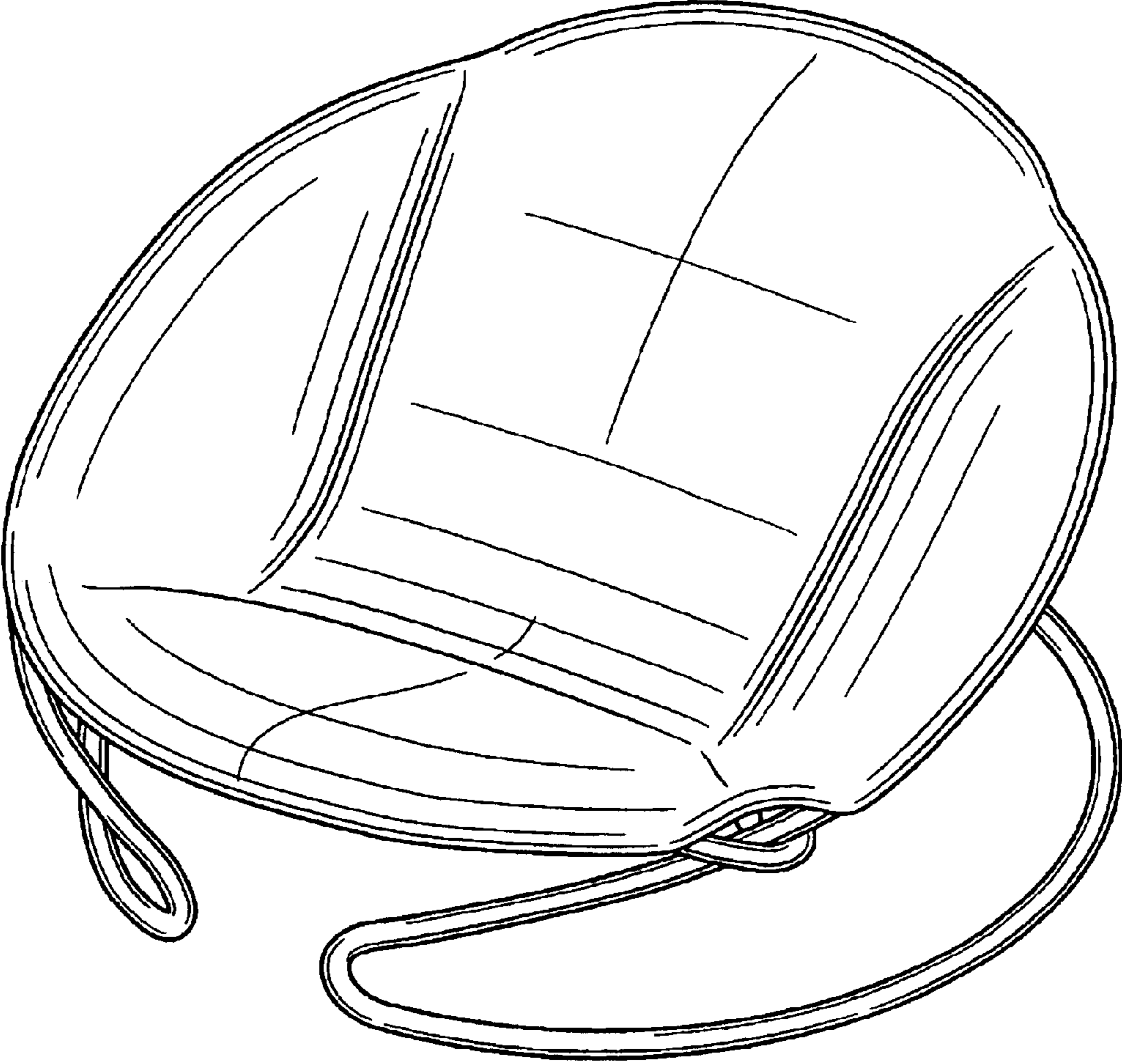

FIG. 1

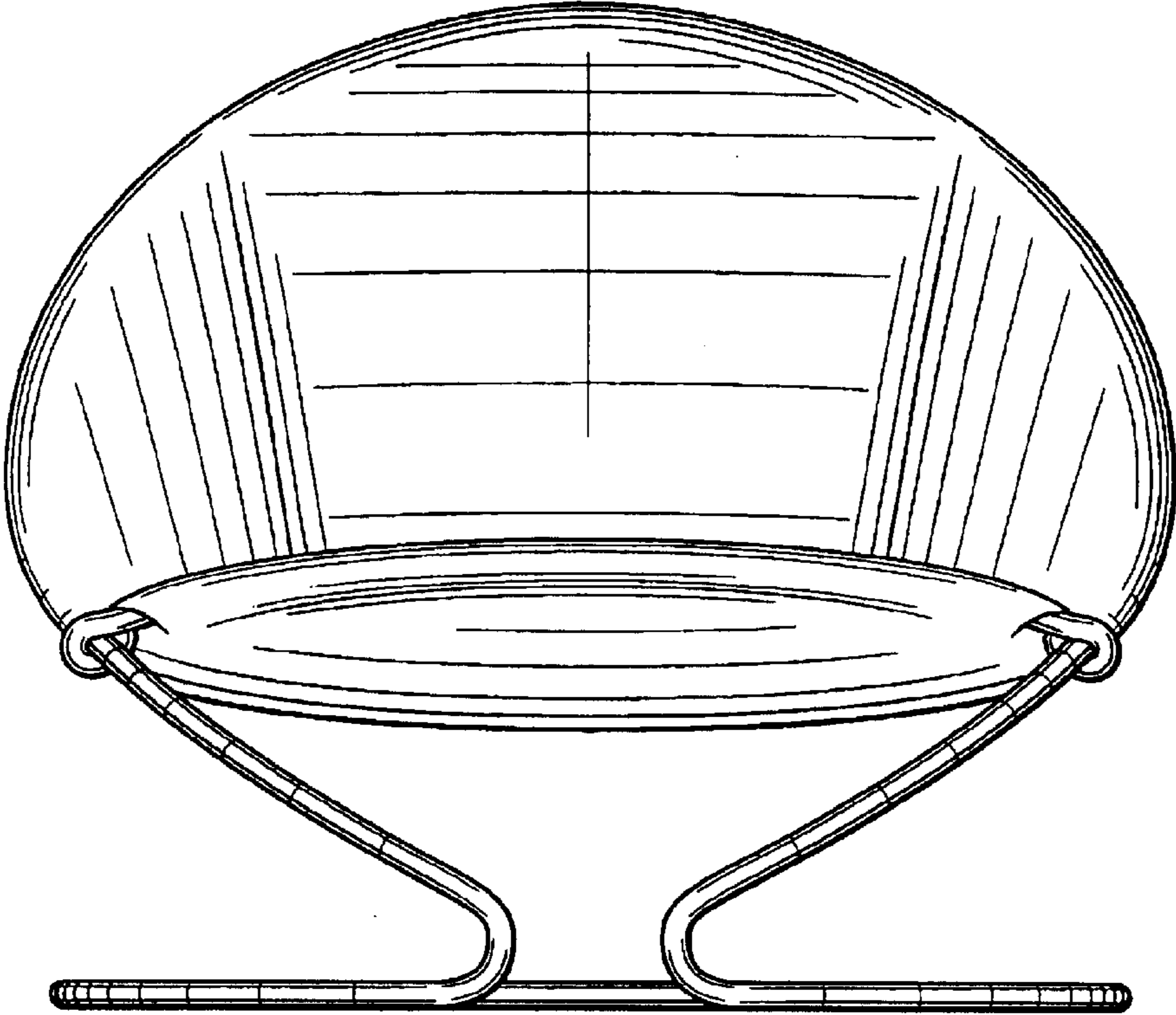

FIG. 2

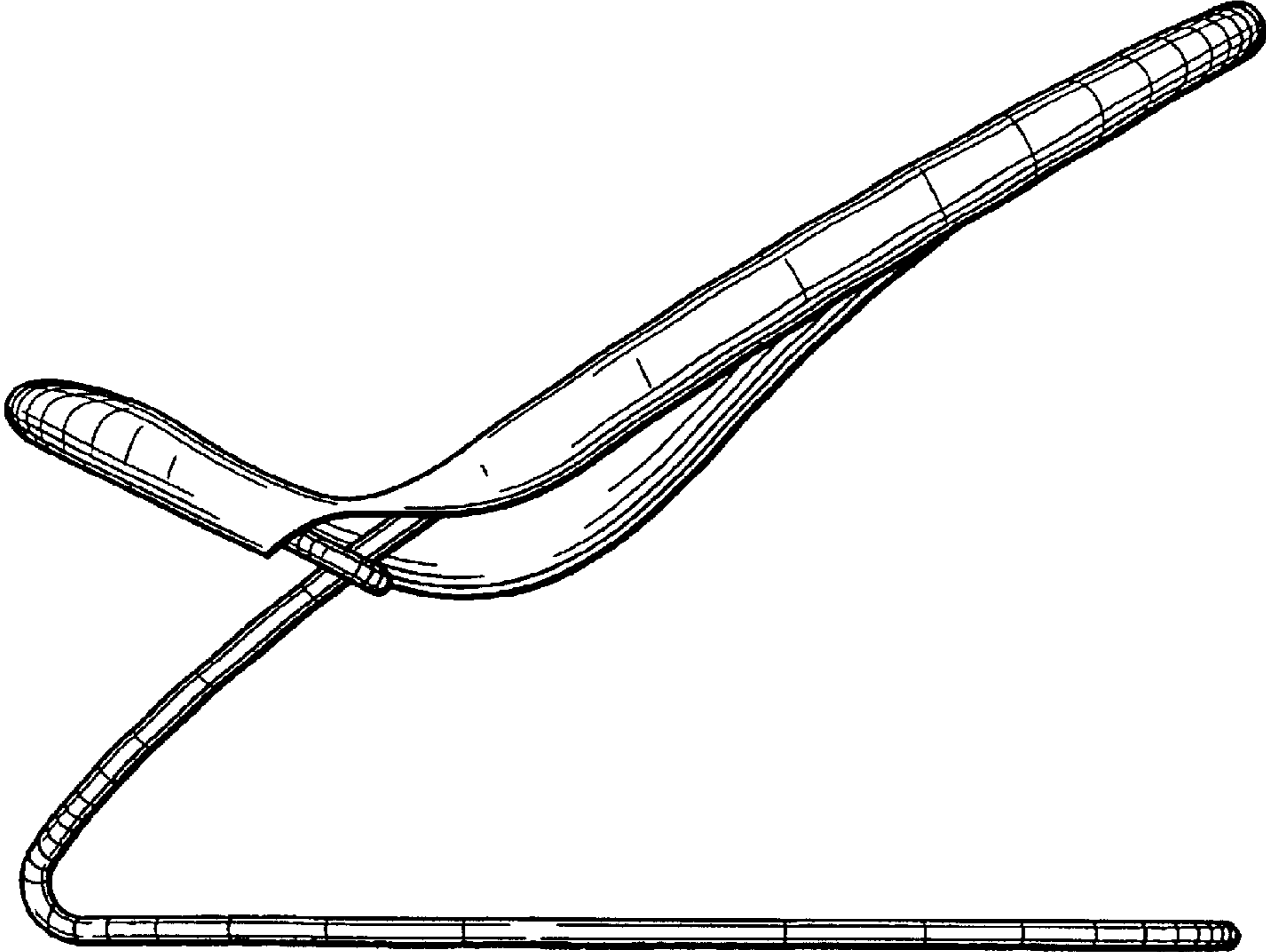

FIG. 3

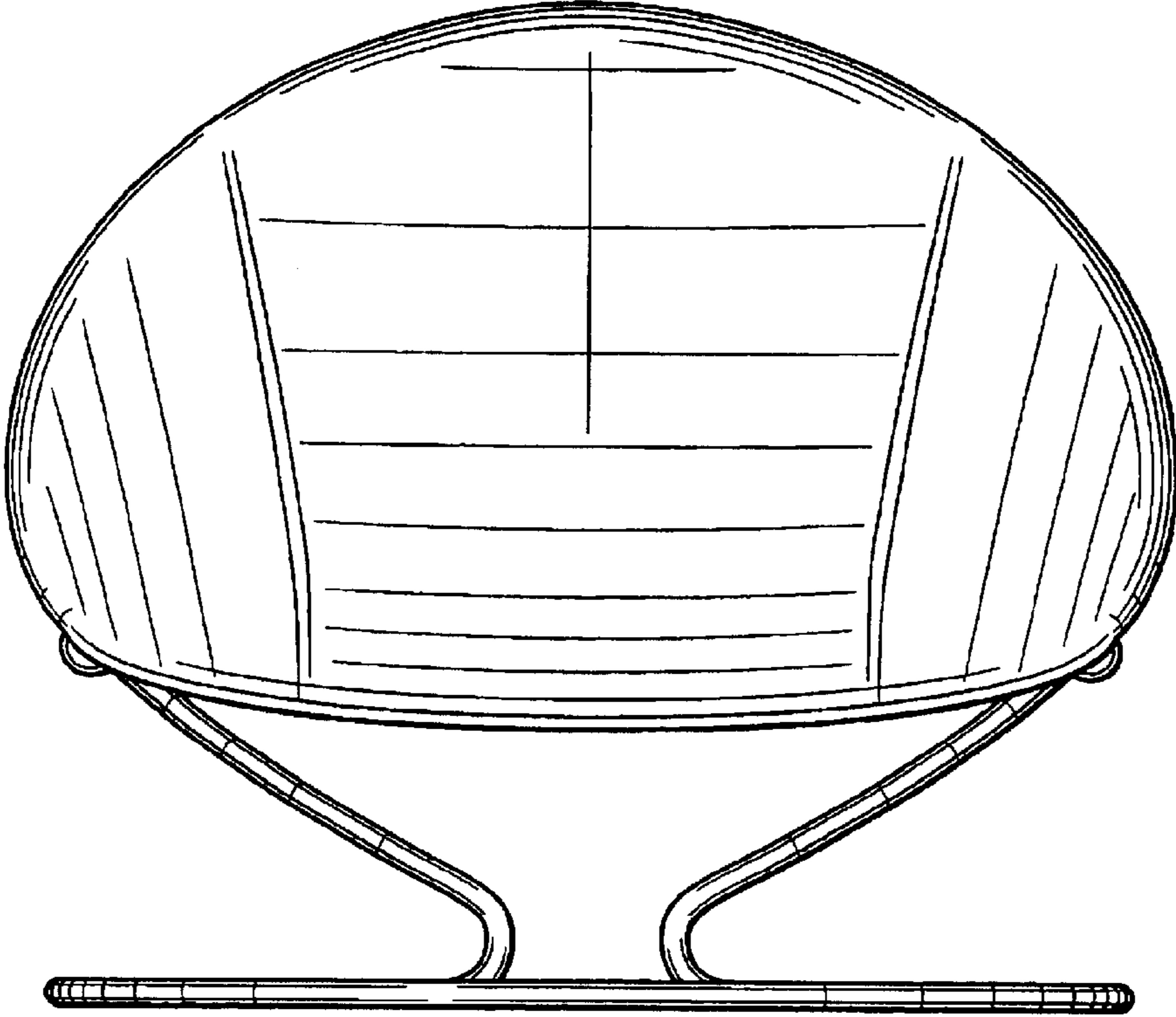

FIG. 4

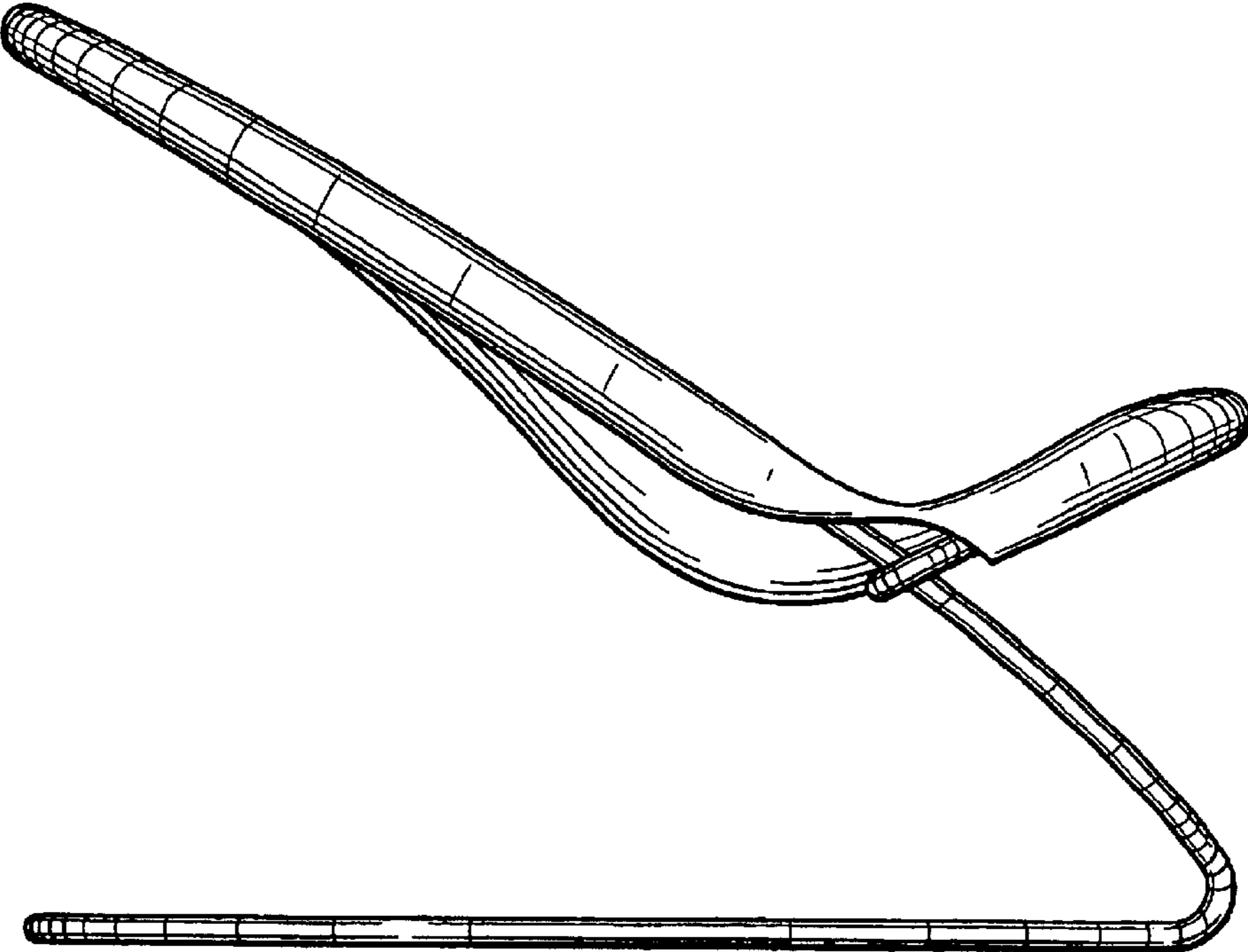

FIG. 5

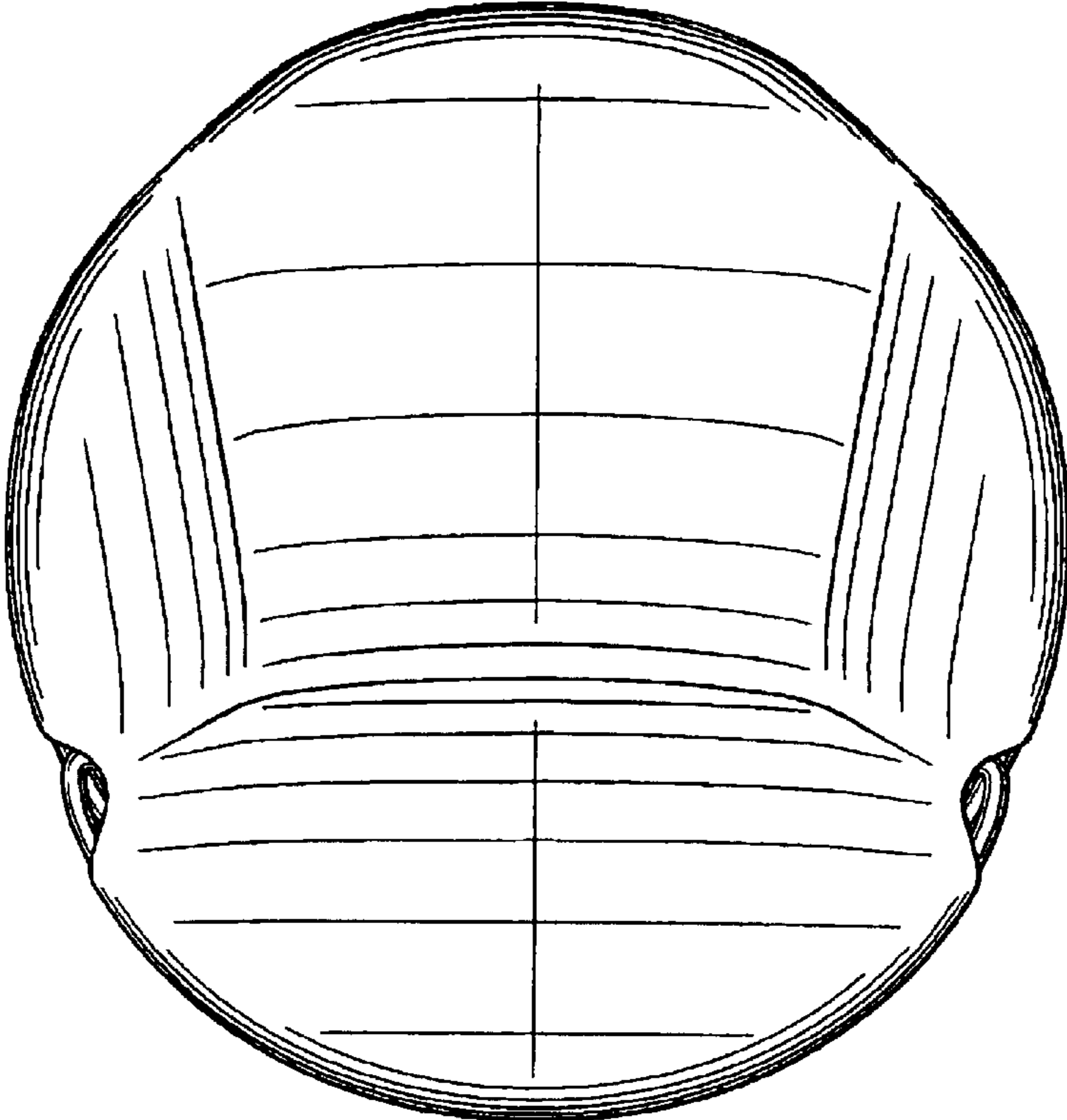

FIG. 6

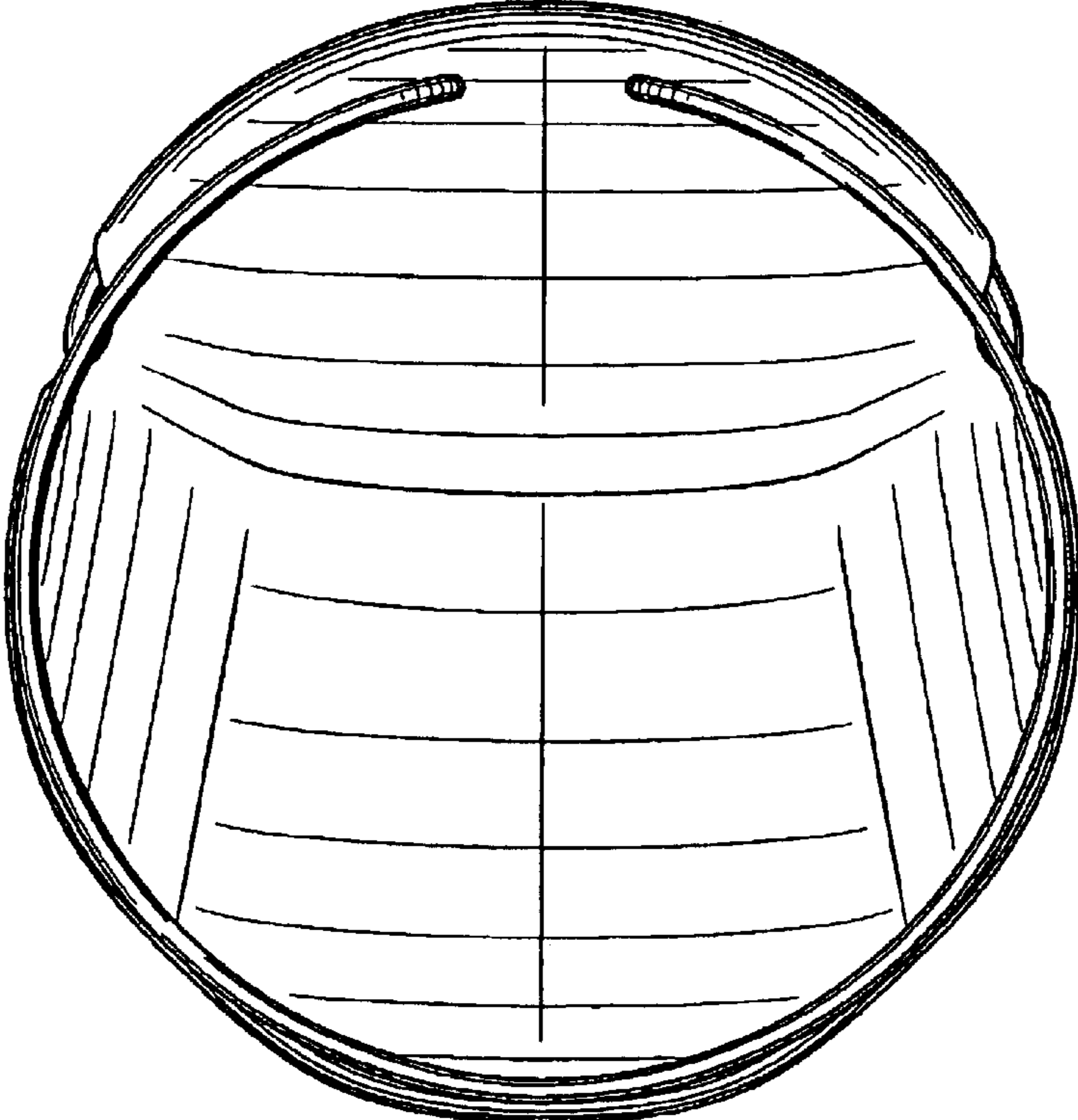

FIG. 7

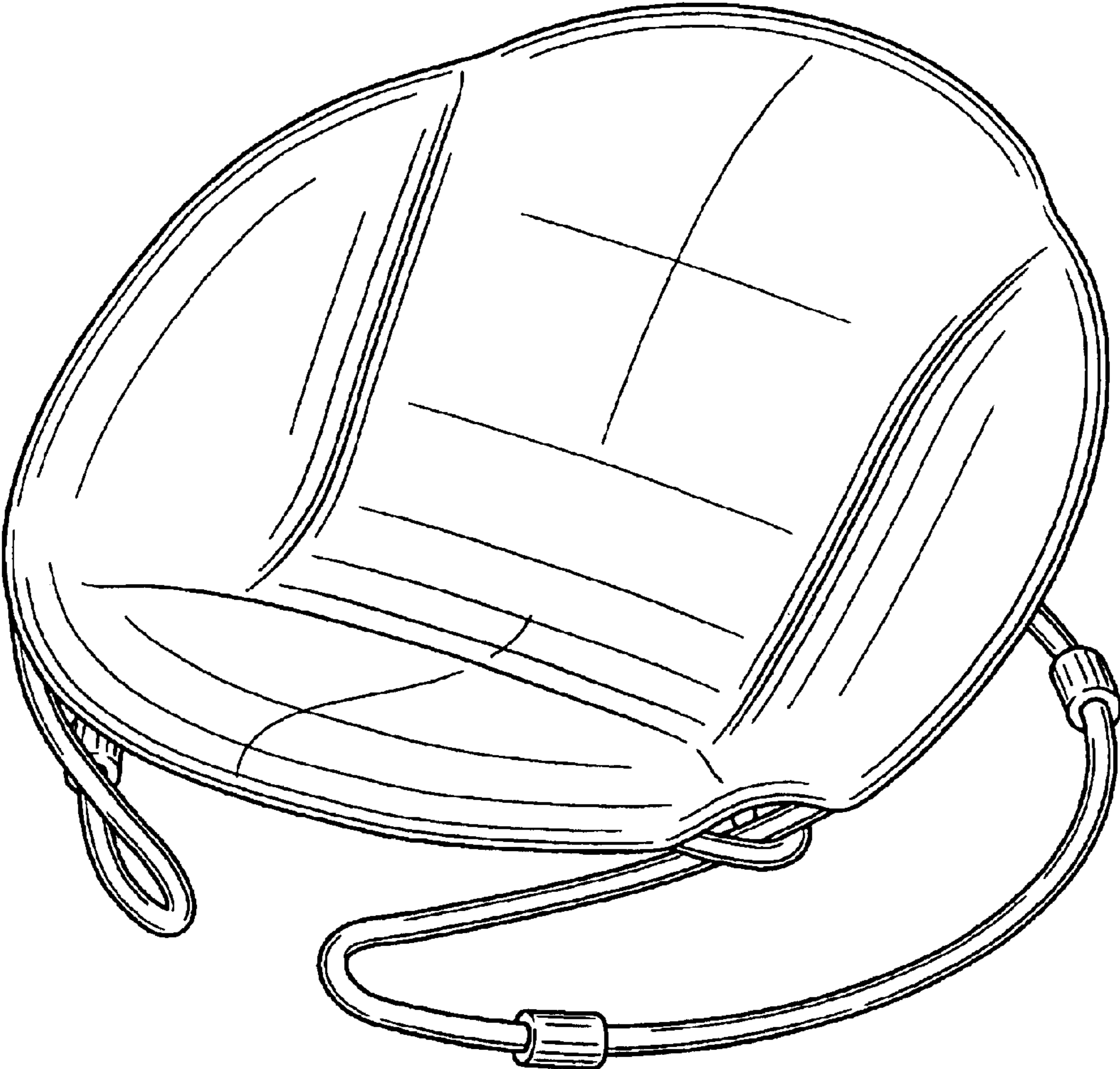

FIG. 8

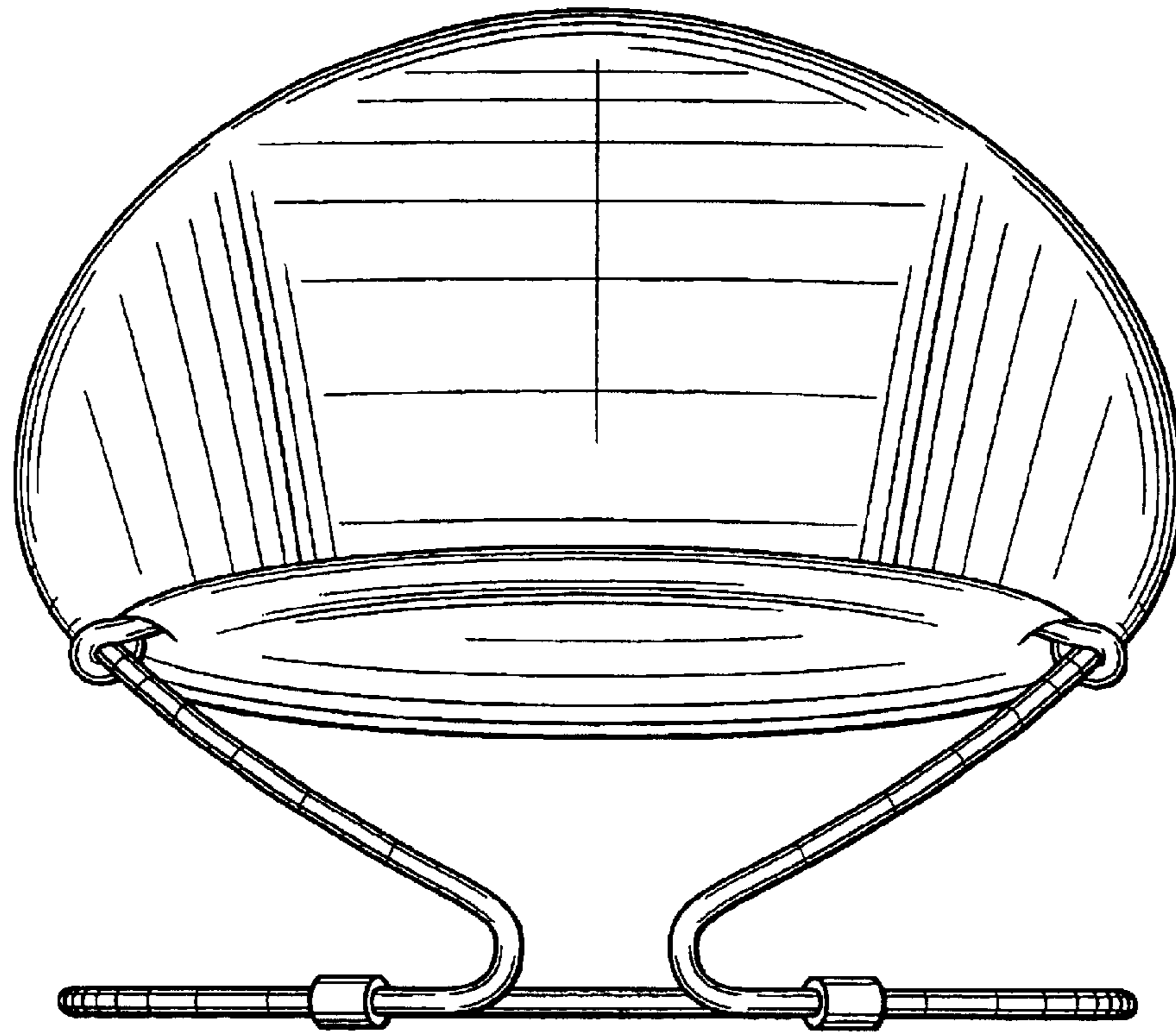

FIG. 9

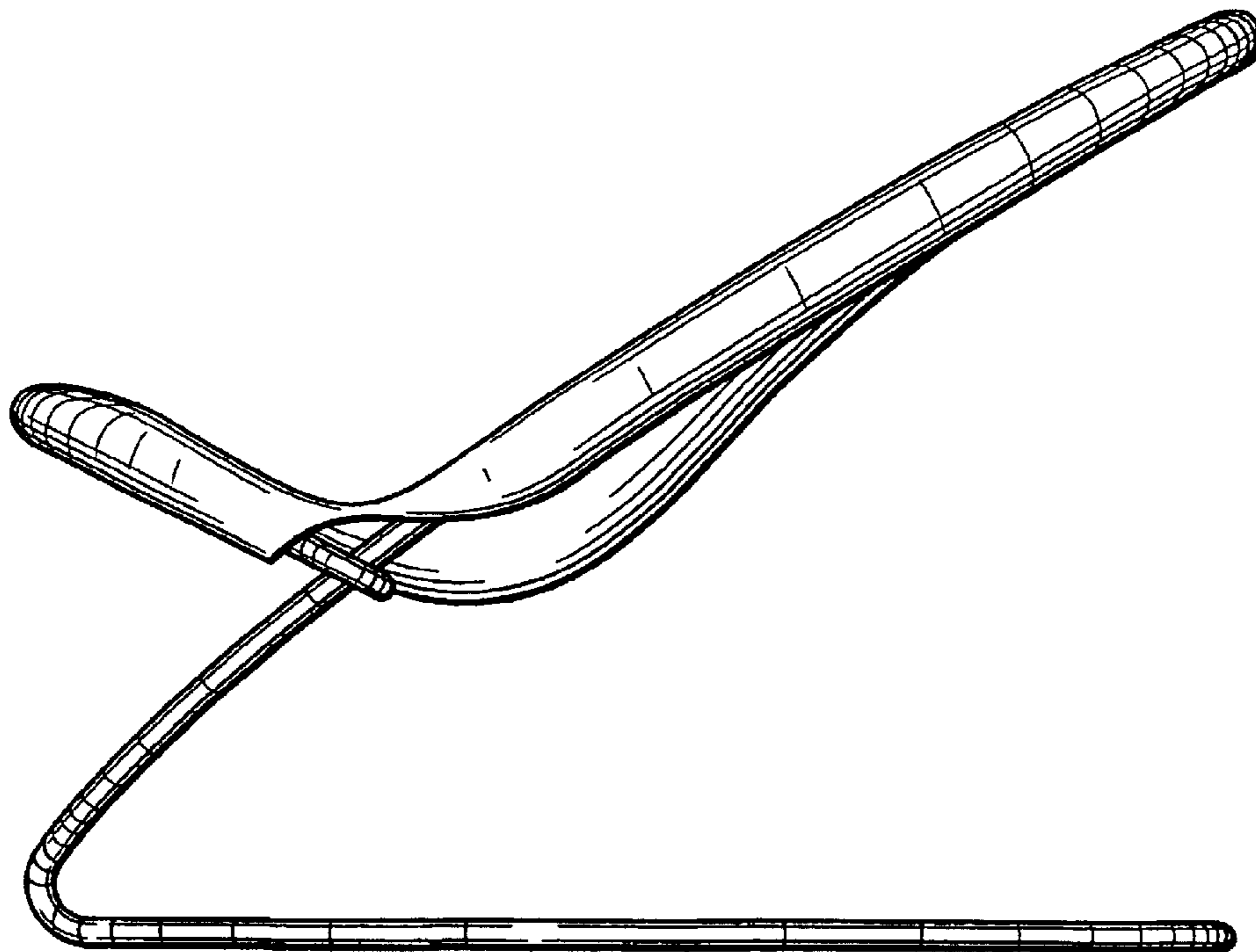

FIG. 10

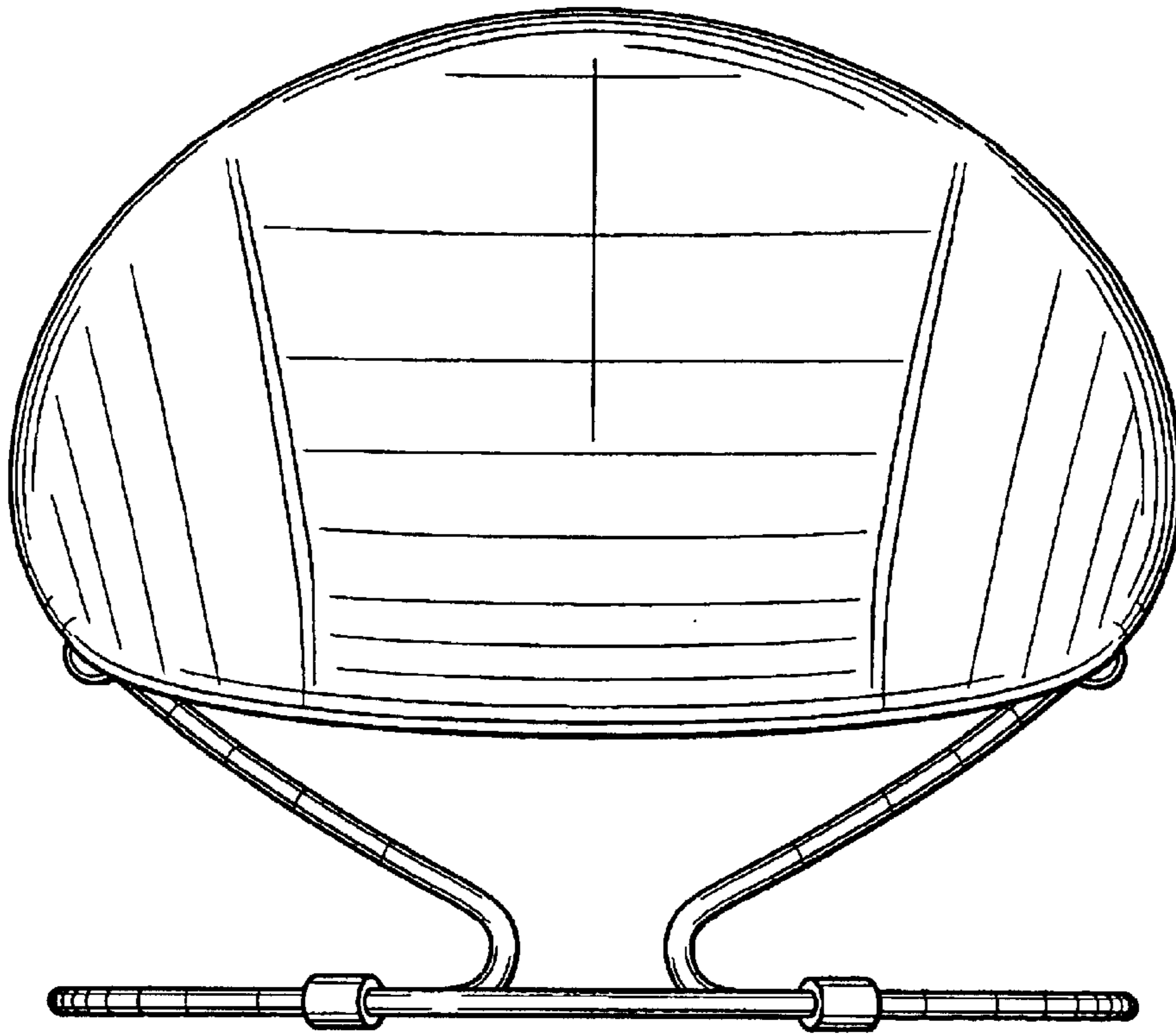

FIG. 11

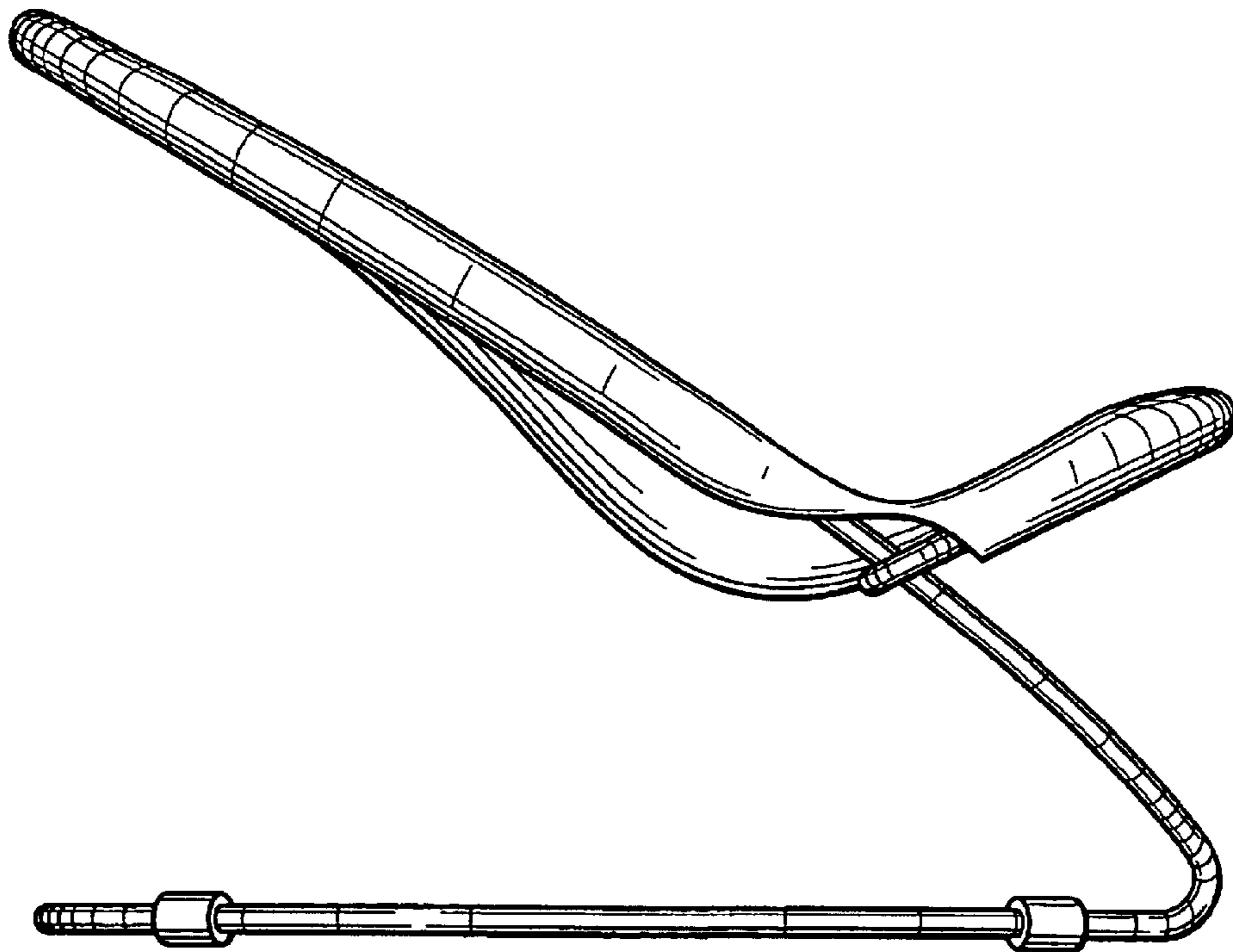

FIG. 12

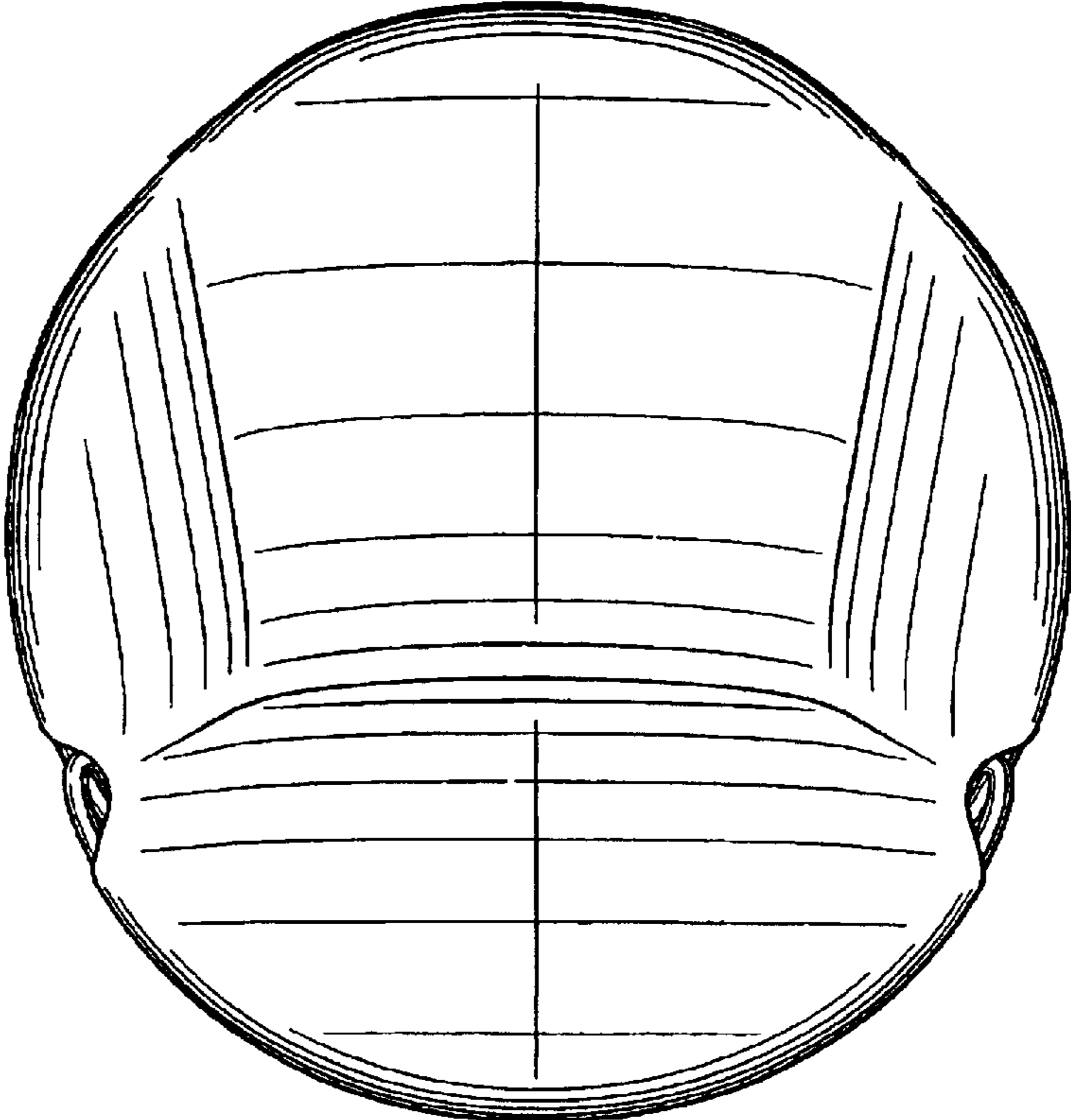

FIG. 13

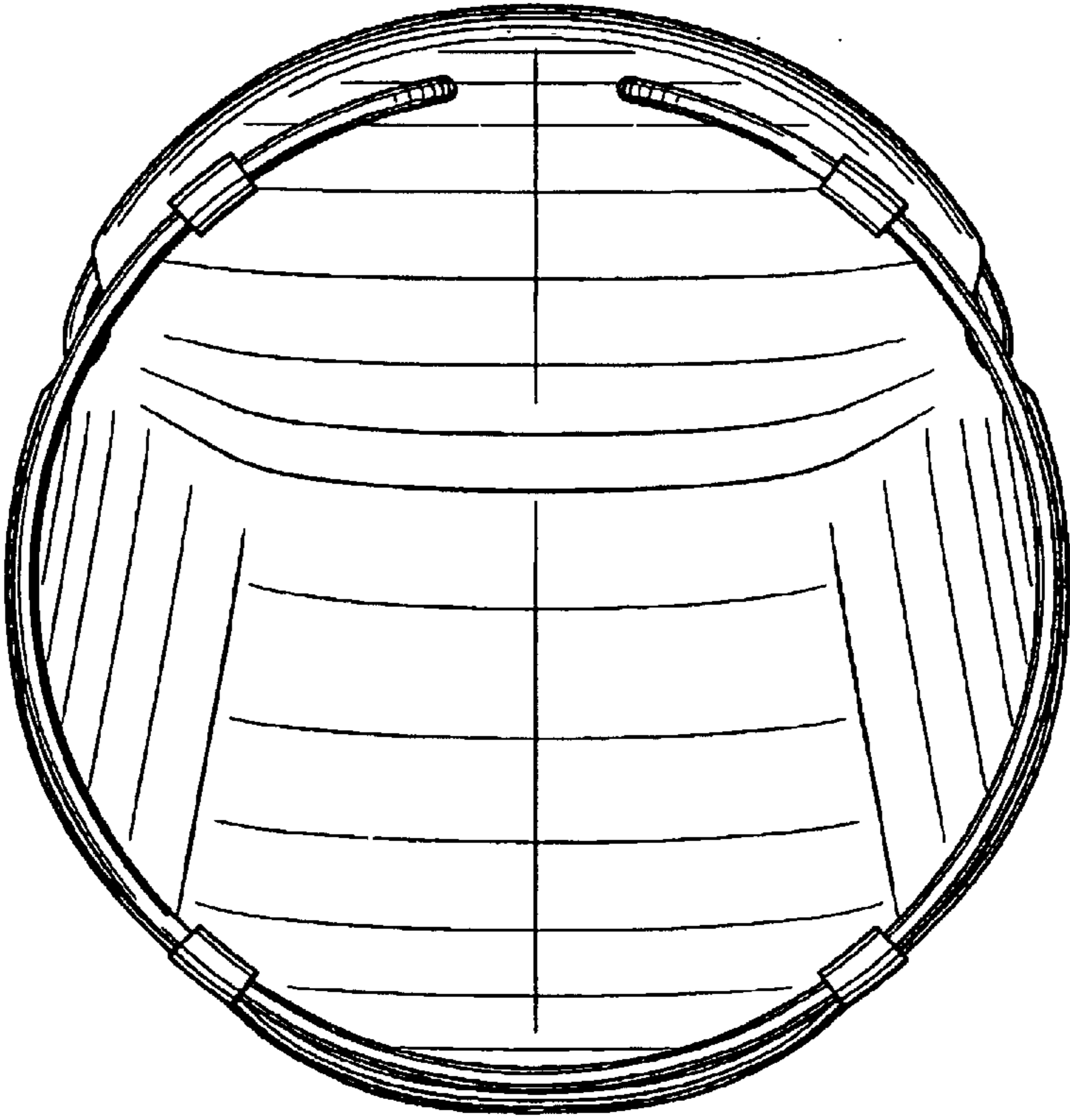

FIG. 14