

US00D507103S

(12) **United States Design Patent**  
**Charles, Jr.**

(10) **Patent No.:** **US D507,103 S**  
(45) **Date of Patent:** **\*\* Jul. 12, 2005**

(54) **ELASTIC WRIST OR ANKLE BAND  
COMPRISING AN INTERIOR TUBULAR  
POCKET, A TRANSPARENT EXTERIOR  
SLEEVE, AND SECRETED INTERIOR  
SLEEVE FOR HOUSING DISCLOSED AND  
HIDDEN ARTICLES AND INFORMATION**

(76) **Inventor:** **Lloyd M. Charles, Jr.**, 7610  
Pennsylvania Ave., Suite 201,  
Forestville, MD (US) 20747

(\*\*) **Term:** **14 Years**

(21) **Appl. No.:** **29/209,715**

(22) **Filed:** **Jul. 21, 2004**

(51) **LOC (8) Cl.** ..... **03-01**

(52) **U.S. Cl.** ..... **D3/216**

(58) **Field of Search** ..... D3/215, 224, 226,  
D3/221, 228, 206; 224/230, 222, 236, 267,  
148.5; 2/170, 38

(56) **References Cited**

**U.S. PATENT DOCUMENTS**

5,752,633	A	*	5/1998	Antaki	.....	224/222
D429,880	S	*	8/2000	McCullough et al.	.....	D3/215
D459,875	S	*	7/2002	Mack et al.	.....	D3/226
6,443,341	B1	*	9/2002	Rittmann	.....	224/219
D487,844	S	*	3/2004	Nichols	.....	D3/215

\* cited by examiner

*Primary Examiner*—Catherine R. Oliver

(74) *Attorney, Agent, or Firm*—Jerome J. Norris

(57) **CLAIM**

The ornamental design for an elastic wrist or ankle band comprising an interior tubular pocket, a transparent exterior sleeve, and secreted interior sleeve for housing disclosed and hidden articles and information, as shown and described.

**DESCRIPTION**

FIG. 1 is a perspective view of the elastic wrist or ankle band comprising an interior tubular pocket, a transparent exterior sleeve and secreted interior sleeve for housing disclosed and hidden articles and information showing my new design; FIG. 2 is a rear view shown with the rear closure open; FIG. 3 is a front view; FIG. 4 is a rear view of FIG. 3; FIG. 5 is a right side view thereof; FIG. 6 is a left side view thereof; FIG. 7 is a top view thereof; FIG. 8 is a bottom view thereof; and, FIG. 9 is a perspective view shown in use.

The broken line showing of environment in the drawings is for illustrative purposes only and forms no part of the claimed design.

**1 Claim, 6 Drawing Sheets**

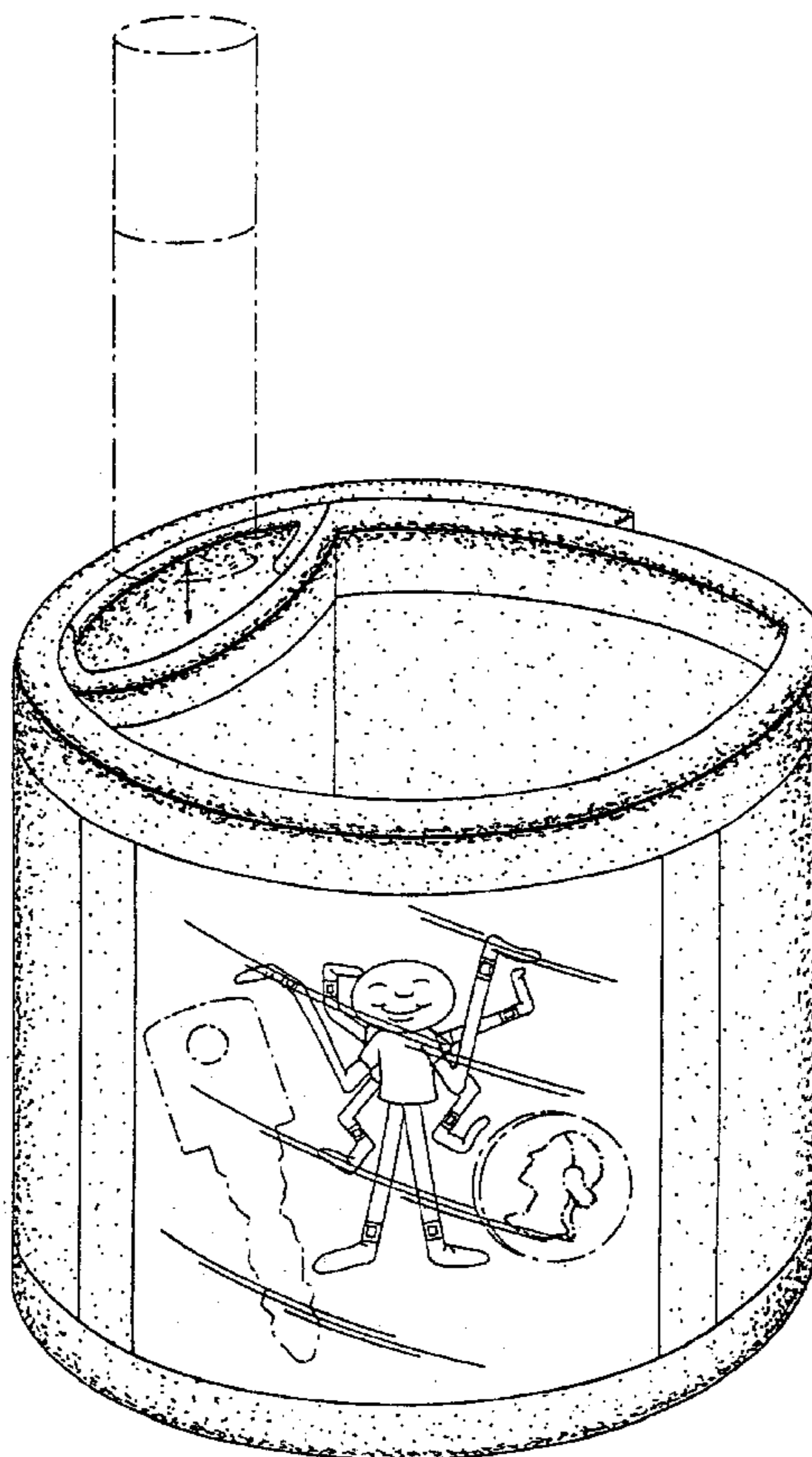

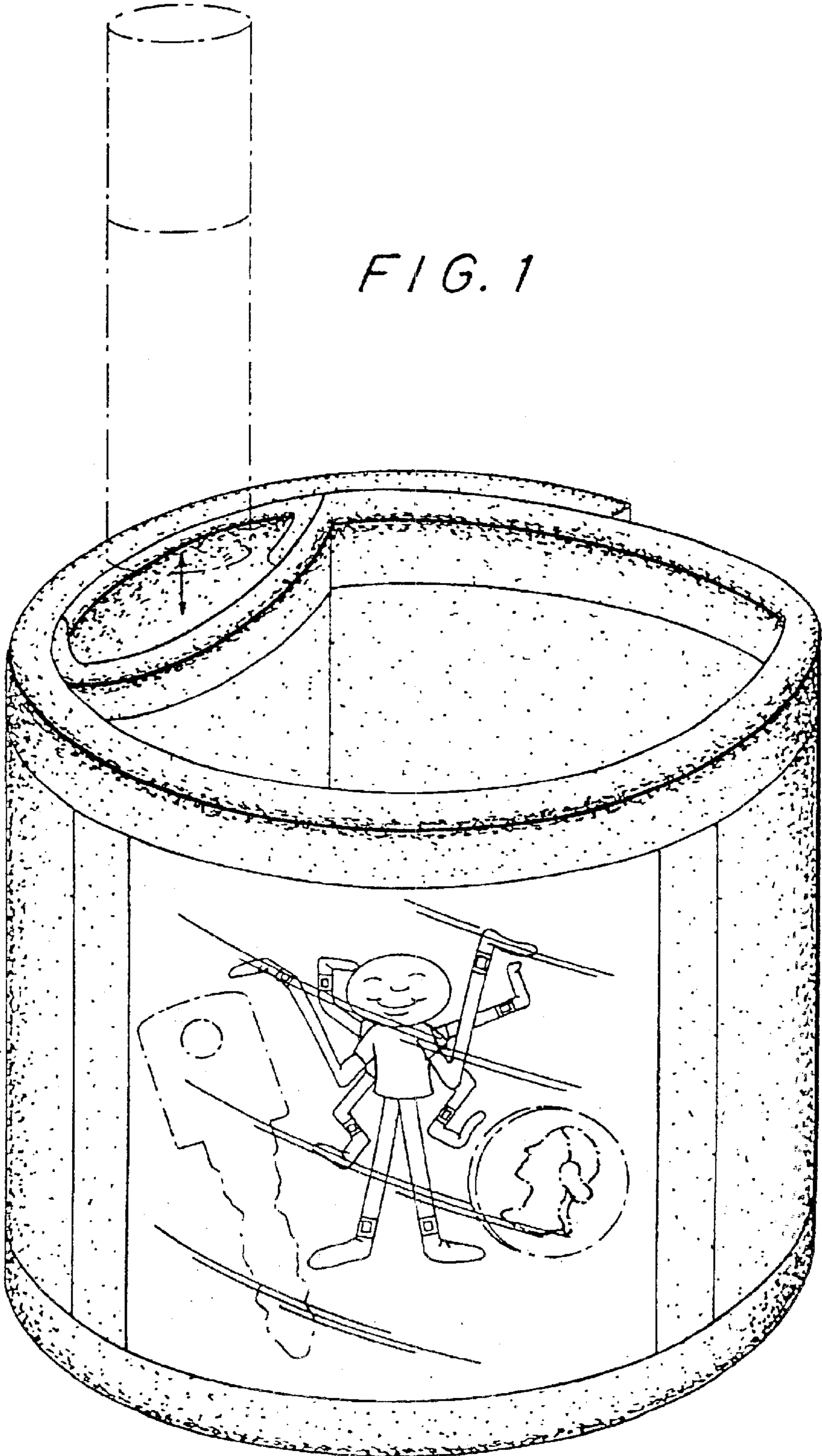

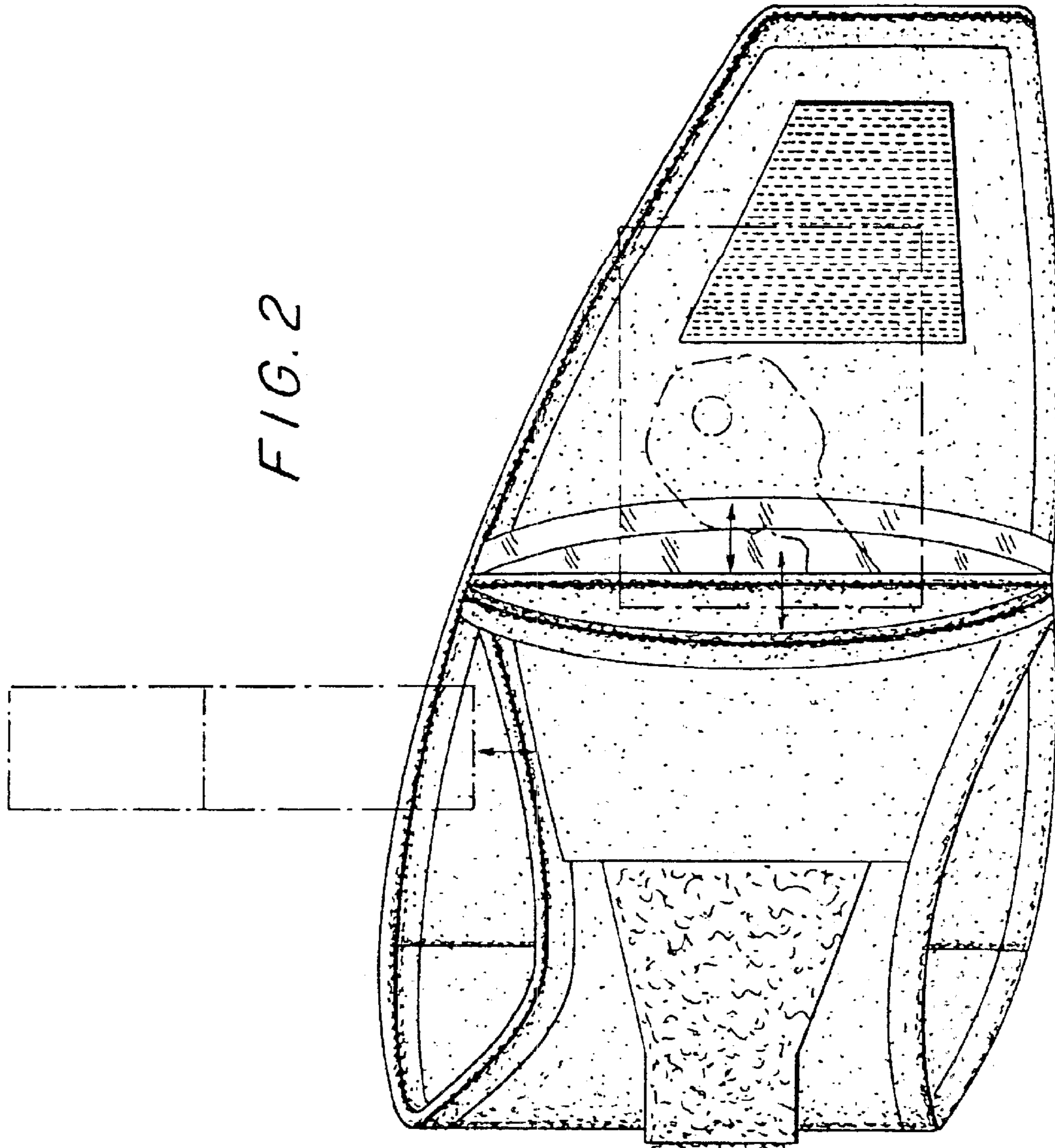

FIG. 3

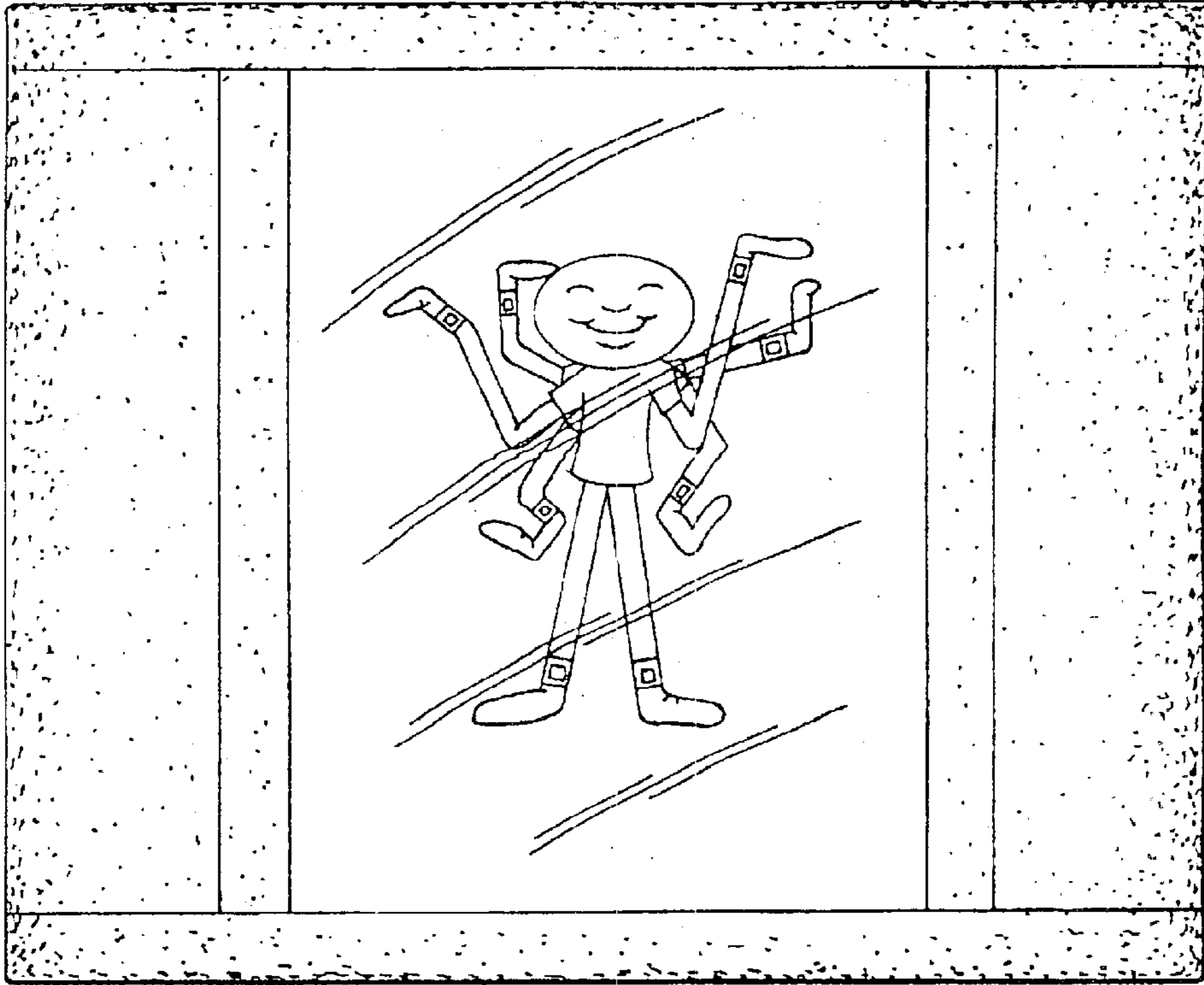

FIG. 4

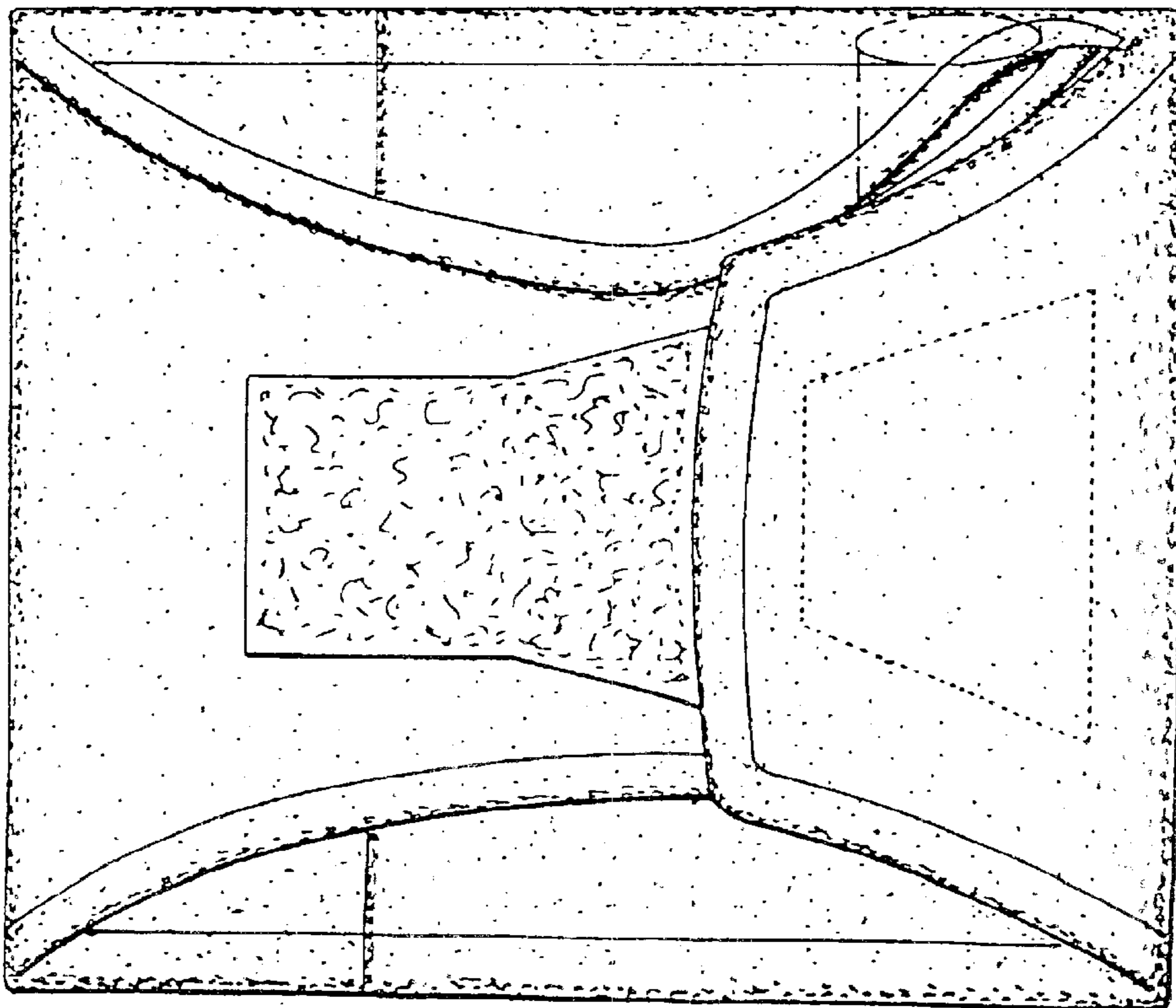

FIG. 5

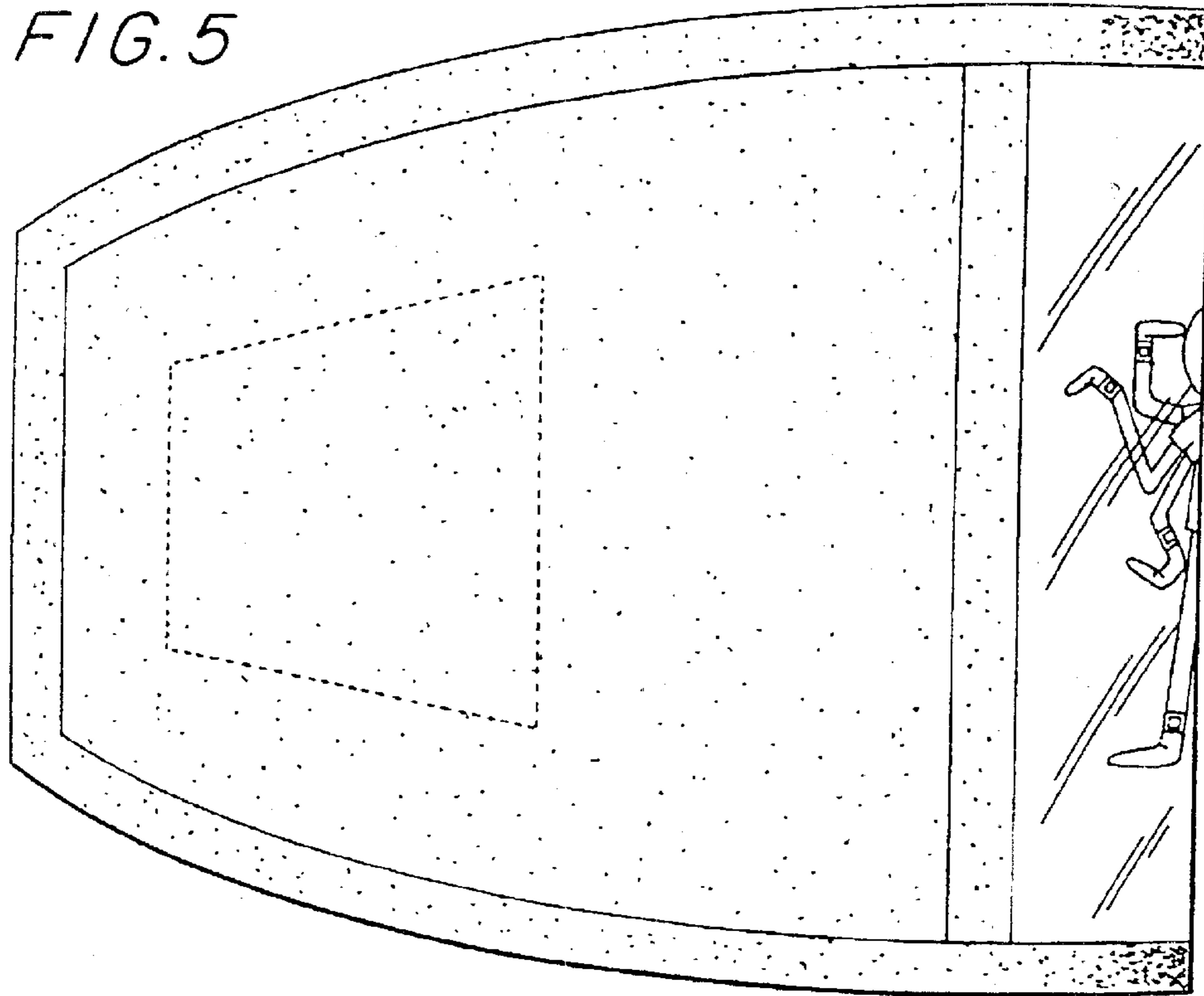

FIG. 6

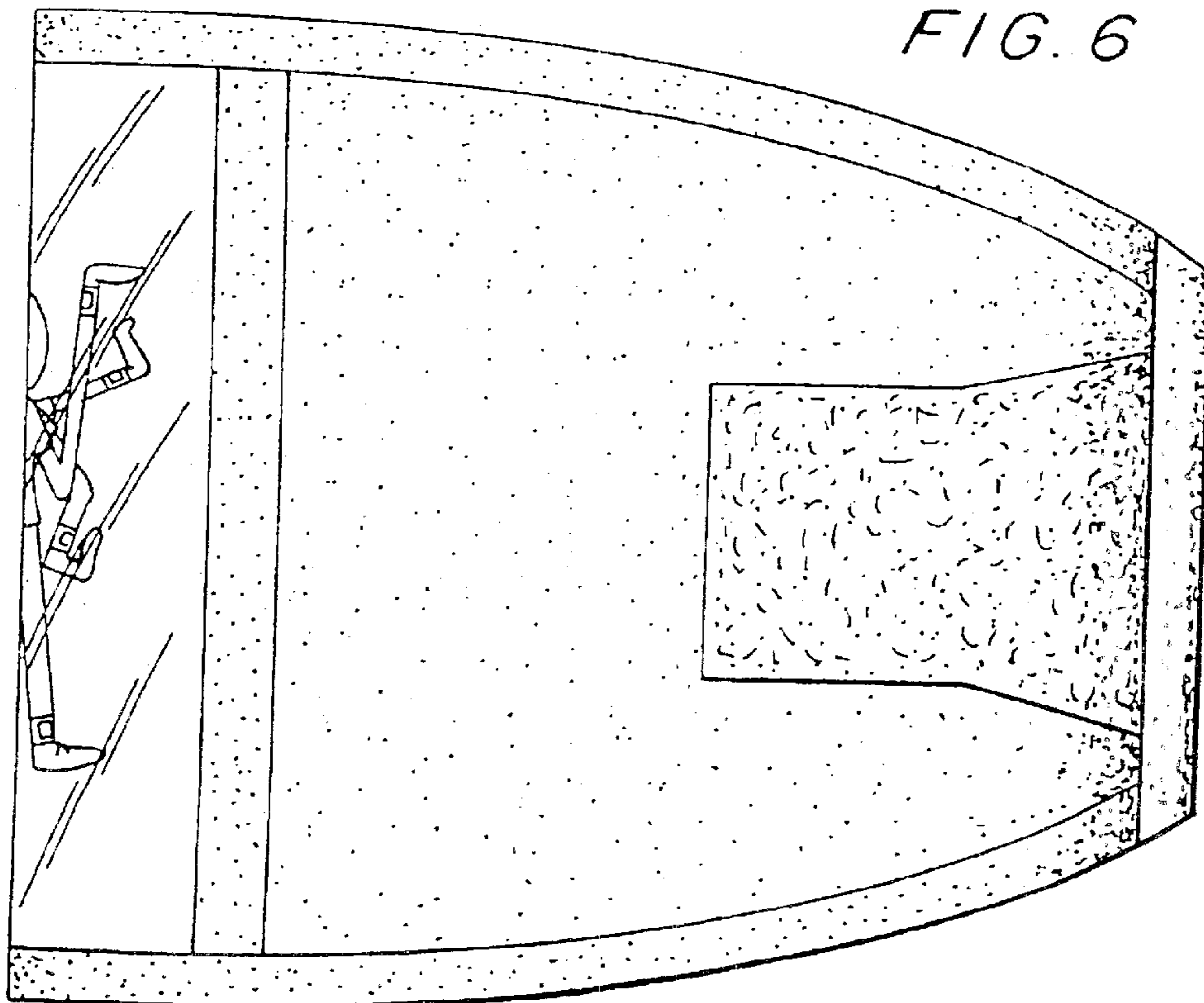

FIG. 7

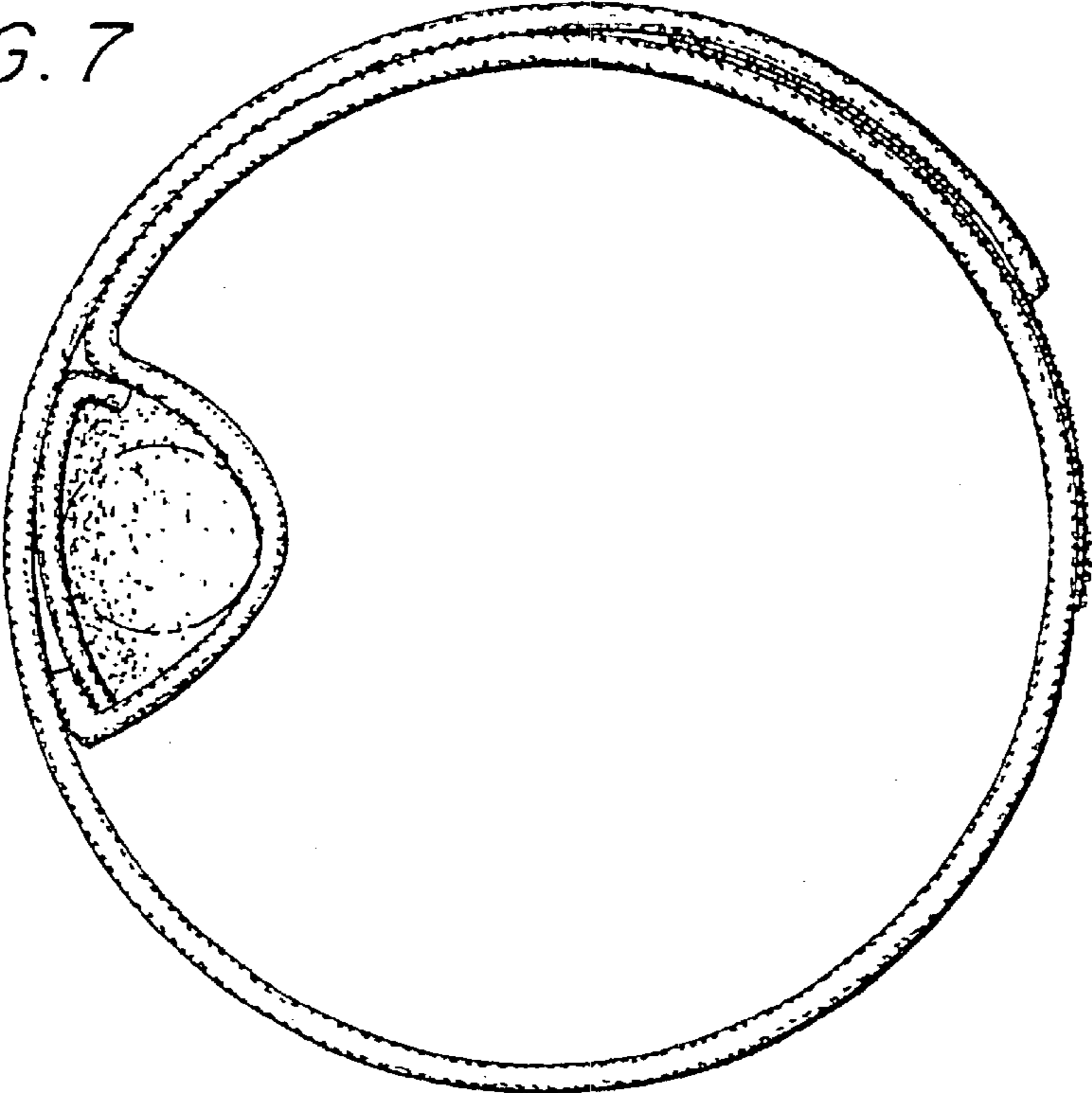

FIG. 8

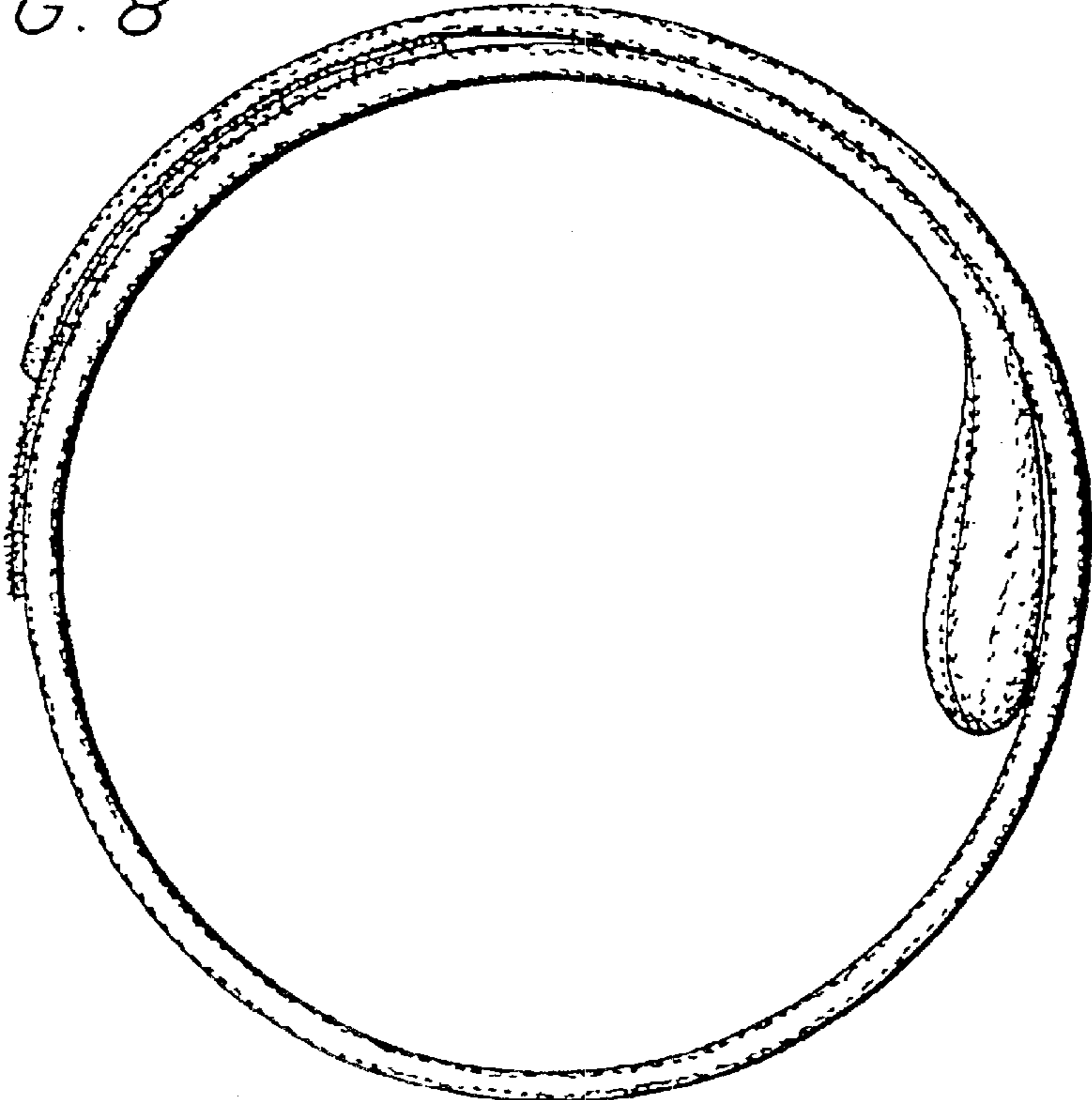

FIG. 9

