

US00D506922S

(12) **United States Design Patent** (10) **Patent No.:** **US D506,922 S**
Simon (45) **Date of Patent:** **** Jul. 5, 2005**

(54) **SCREW**

(76) Inventor: **Larry Simon**, 1440 Dalton Rd.,
Timmins, Ontario (CA), P4W 7C2

(**) Term: **14 Years**

(21) Appl. No.: **29/194,781**

(22) Filed: **Dec. 2, 2003**

(30) **Foreign Application Priority Data**

Aug. 7, 2003 (CA) 103627

(51) **LOC (8) Cl.** **08-08**

(52) **U.S. Cl.** **D8/387**

(58) **Field of Search** D8/387; 411/403,
411/405, 378

(56) **References Cited**

U.S. PATENT DOCUMENTS

RE6,730 E	*	11/1875	Cummings	411/403
D103,304 S	*	2/1937	Brown	D8/387
2,084,079 A	*	6/1937	Clark	411/403
2,169,460 A	*	8/1939	Broughton	411/403
2,362,999 A	*	11/1944	Hewitt	411/403
2,914,984 A	*	12/1959	Ansingh	411/403
2,996,943 A	*	8/1961	Johnson	411/403
D303,494 S		9/1989	Lange		
D415,676 S		10/1999	Negishi et al.		
D416,475 S		11/1999	DePrisco		
D469,007 S		1/2003	Chen et al.		

OTHER PUBLICATIONS

AU 135737 S (Mampay Screw Works, Ltd) Dec. 4, 1998
[online] [retrieved on Oct. 11, 2004]. Retrieved from Aus-
tralian patent database.*

AU 111443 S (W.A.Deutcher Pty Ltd) Jul. 5, 1991 [online]
[retrieved on Oct. 11, 2004] Retrieved from Australian
patent database.*

* cited by examiner

Primary Examiner—Holly Baynham

(74) *Attorney, Agent, or Firm*—Dyen Wiggs Green &
Mutala

(57) **CLAIM**

The ornamental design for a screw, as shown and described.

DESCRIPTION

FIG. 1 is a perspective view of one embodiment of a screw
showing my new design;

FIG. 2 is a top view thereof;

FIG. 3 is a sectional view thereof along line 3—3 of FIG. 2;

FIG. 4 is a sectional view thereof along line 4—4 of FIG. 2;

FIG. 5 is a perspective view of a modified embodiment of a
screw showing my new design;

FIG. 6 is a top view thereof;

FIG. 7 is a sectional view thereof along line 7—7 of FIG. 6;

FIG. 8 is a sectional view thereof along line 8—8 of FIG. 6;

FIG. 9 is a perspective view a modified embodiment of a
screw showing my new design;

FIG. 10 is a top view thereof;

FIG. 11 is a sectional view thereof along line 11—11 of FIG.
10;

FIG. 12 is a sectional view thereof along line 12—12 of FIG.
10;

FIG. 13 is a perspective view of a modified embodiment of
a screw showing my new design;

FIG. 14 is a top view thereof;

FIG. 15 is a sectional view thereof along line 15—15 of FIG.
14; and,

FIG. 16 is a sectional view thereof along line 16—16 of FIG.
14.

The broken lines shown in the figures represent the shank of
a screw which is shown for illustrative purposes only and do
not form part of the design.

1 Claim, 2 Drawing Sheets

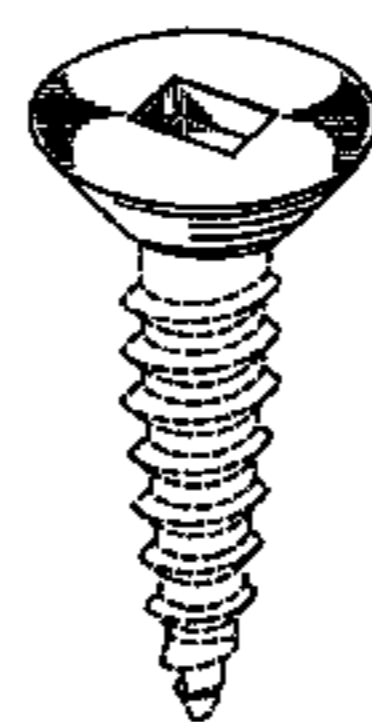

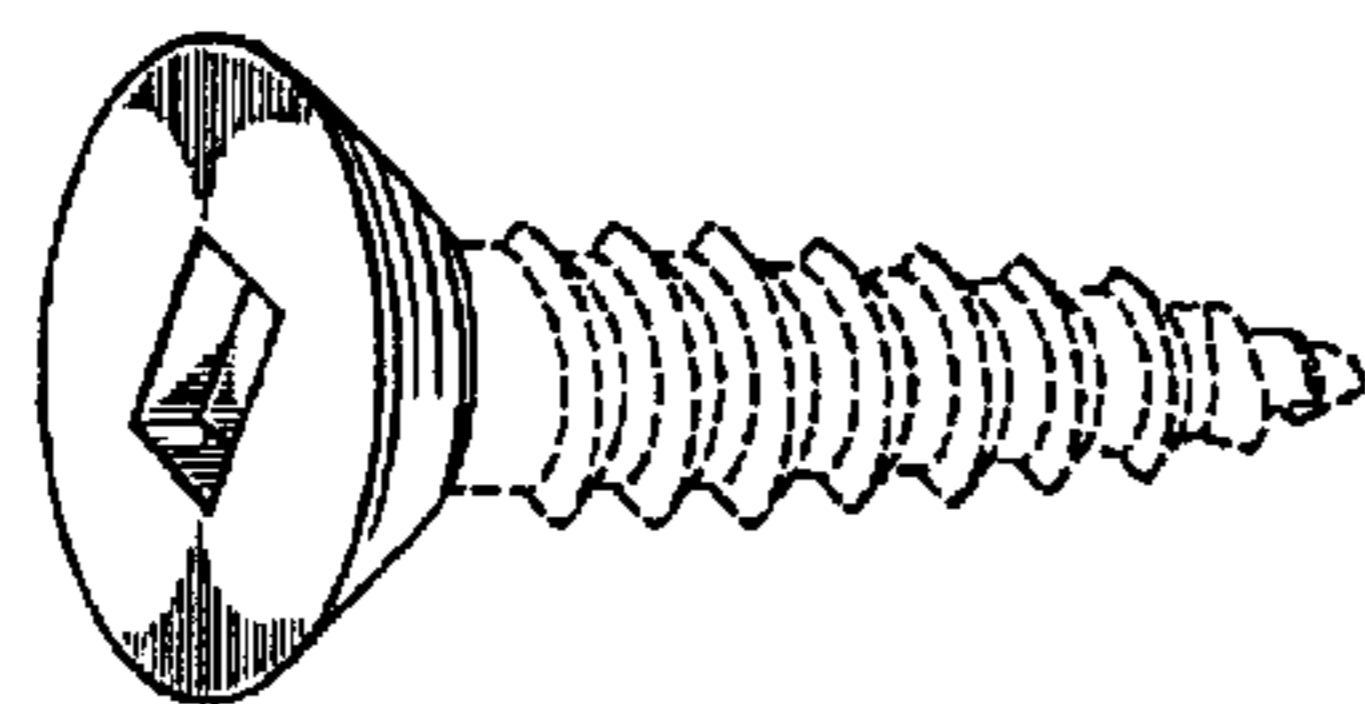

FIG. 1

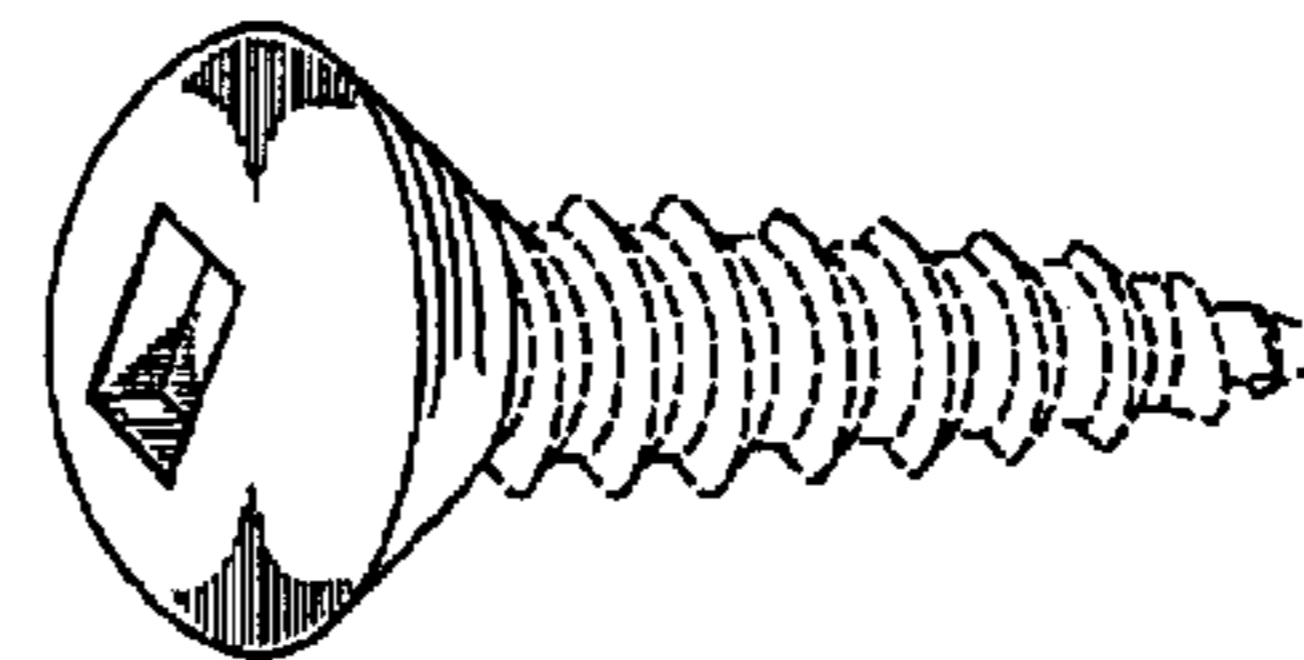

FIG. 5

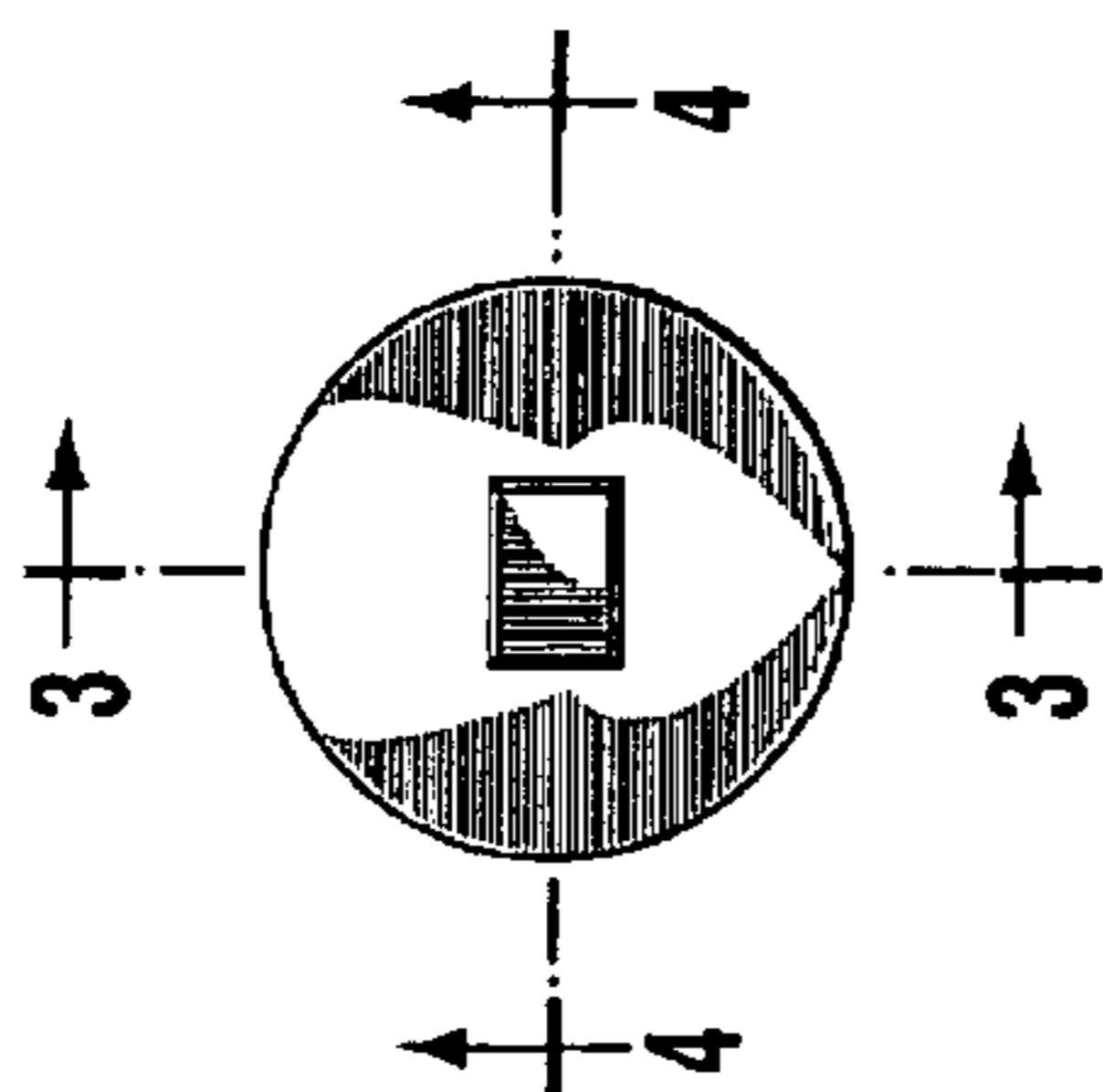

FIG. 2

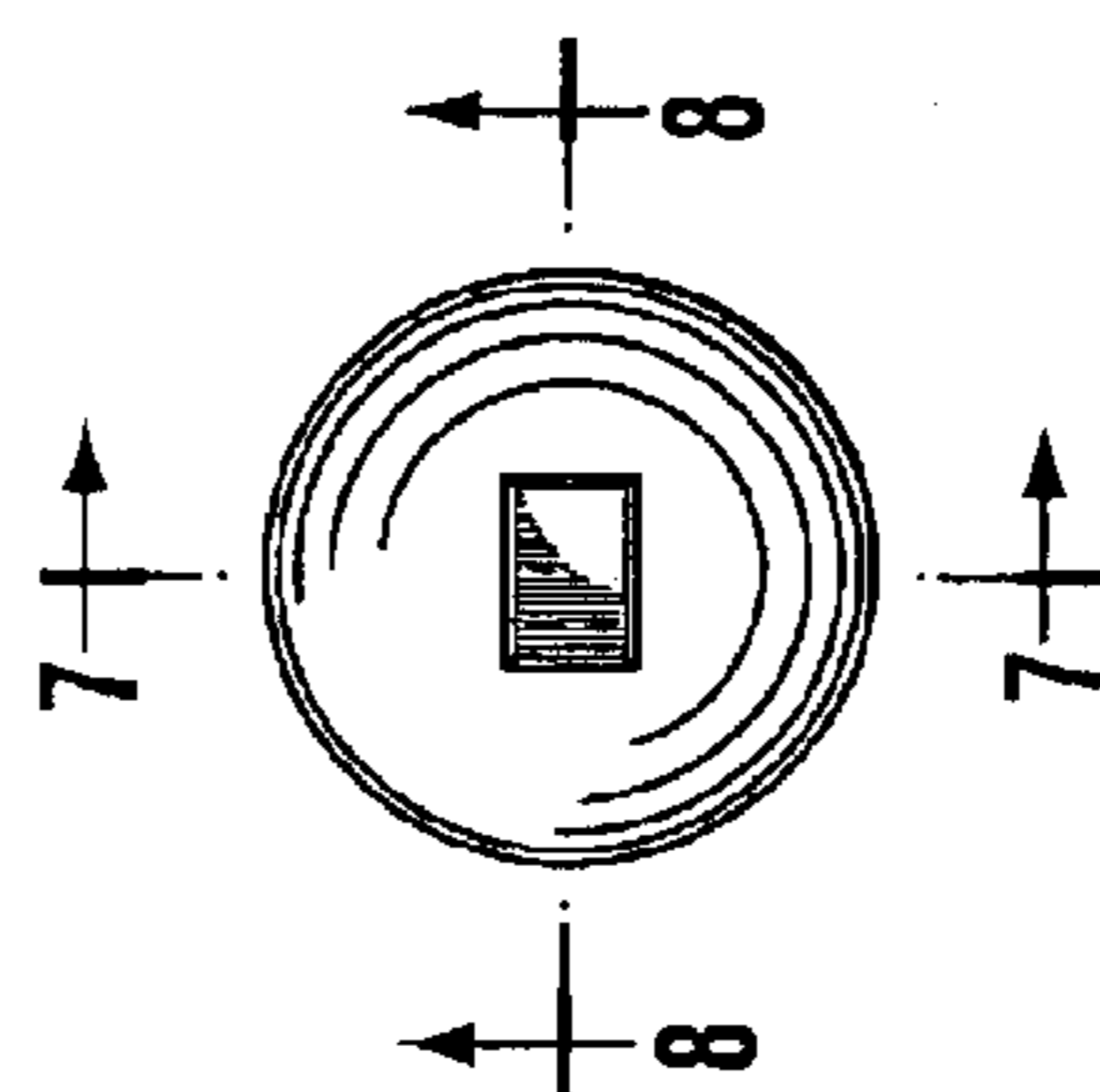

FIG. 6

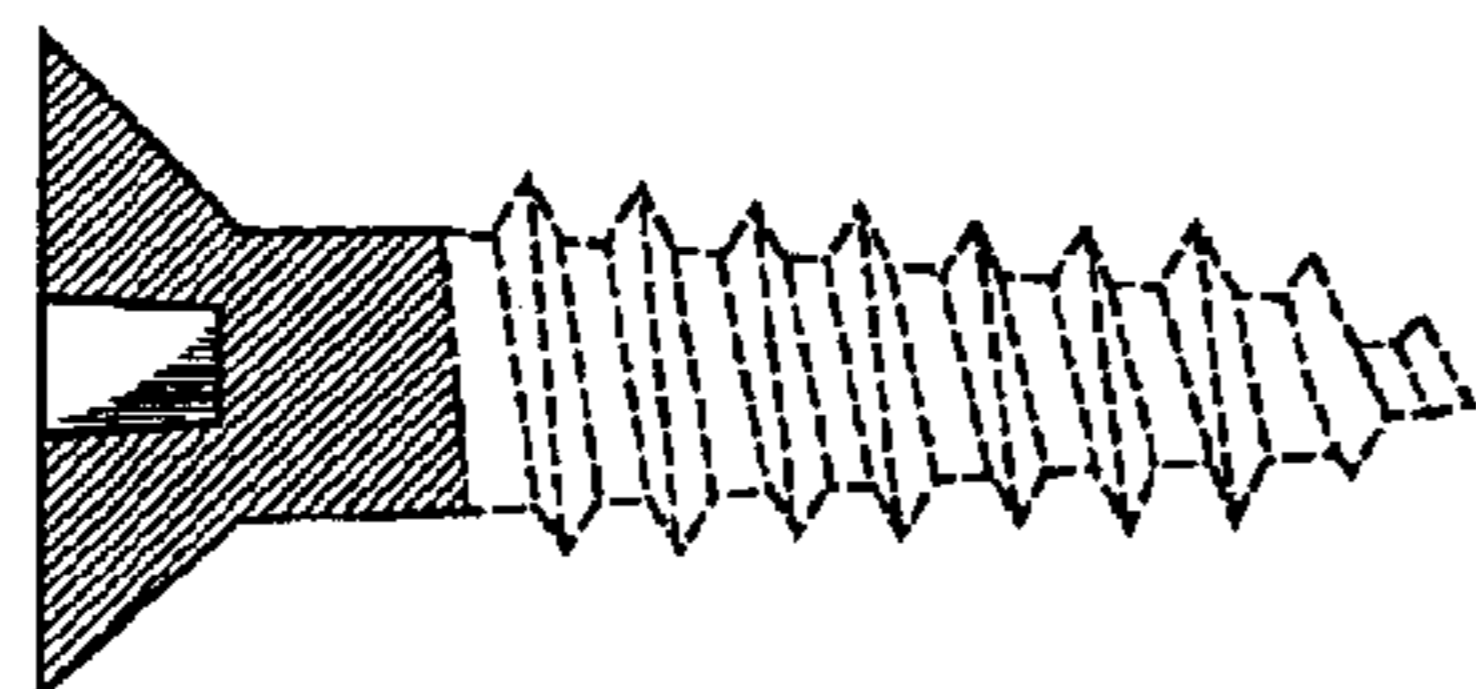

FIG. 3

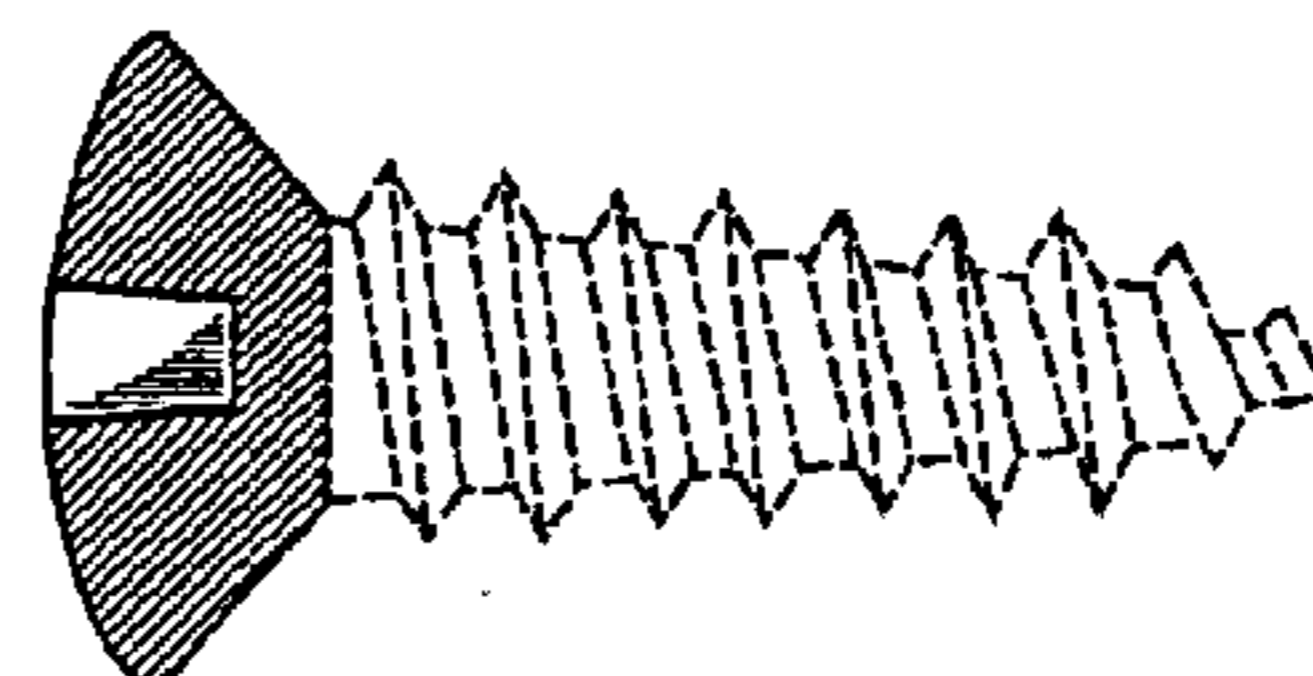

FIG. 7

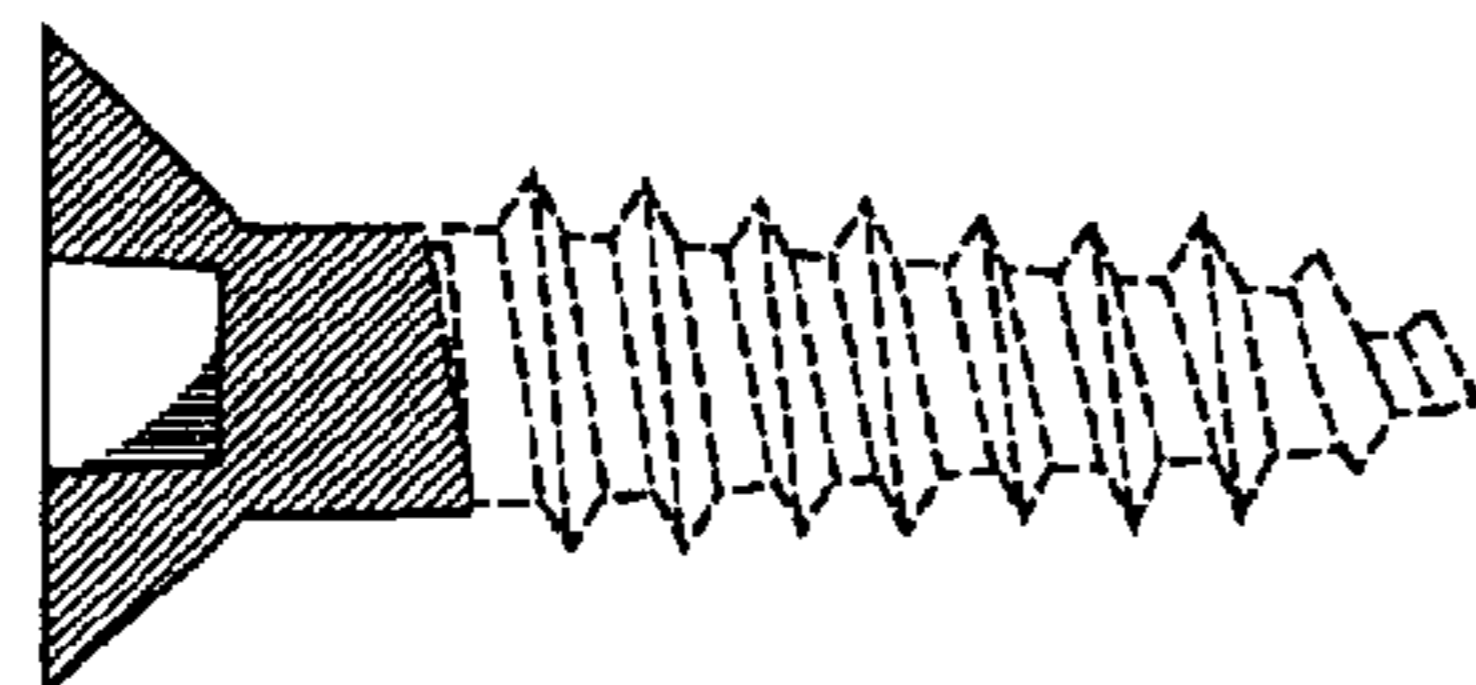

FIG. 4

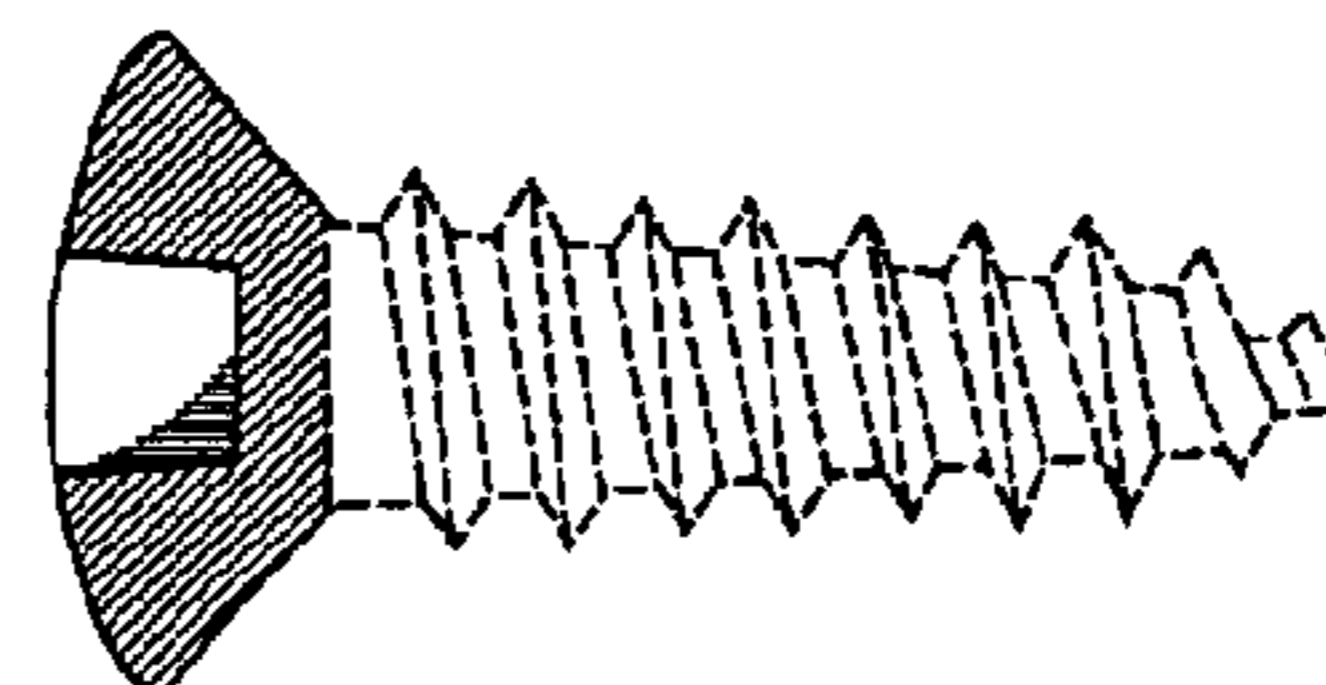

FIG. 8

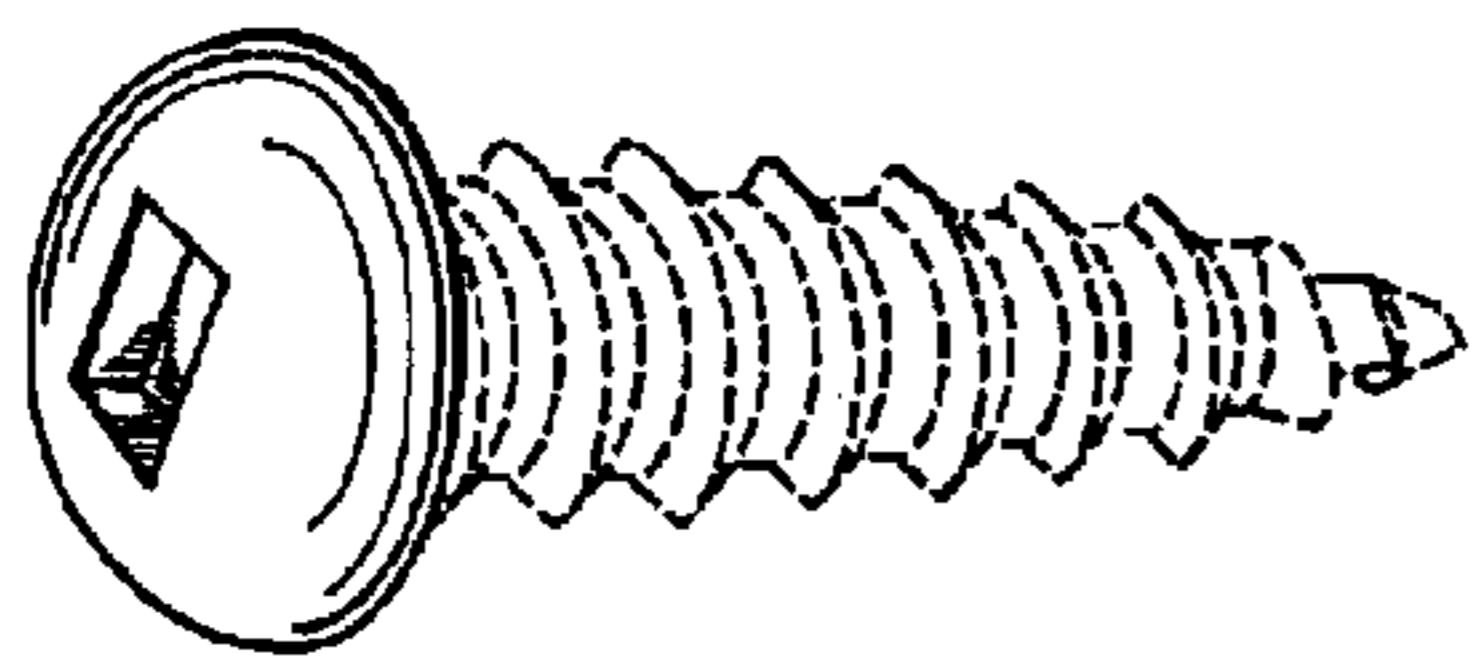

FIG. 9

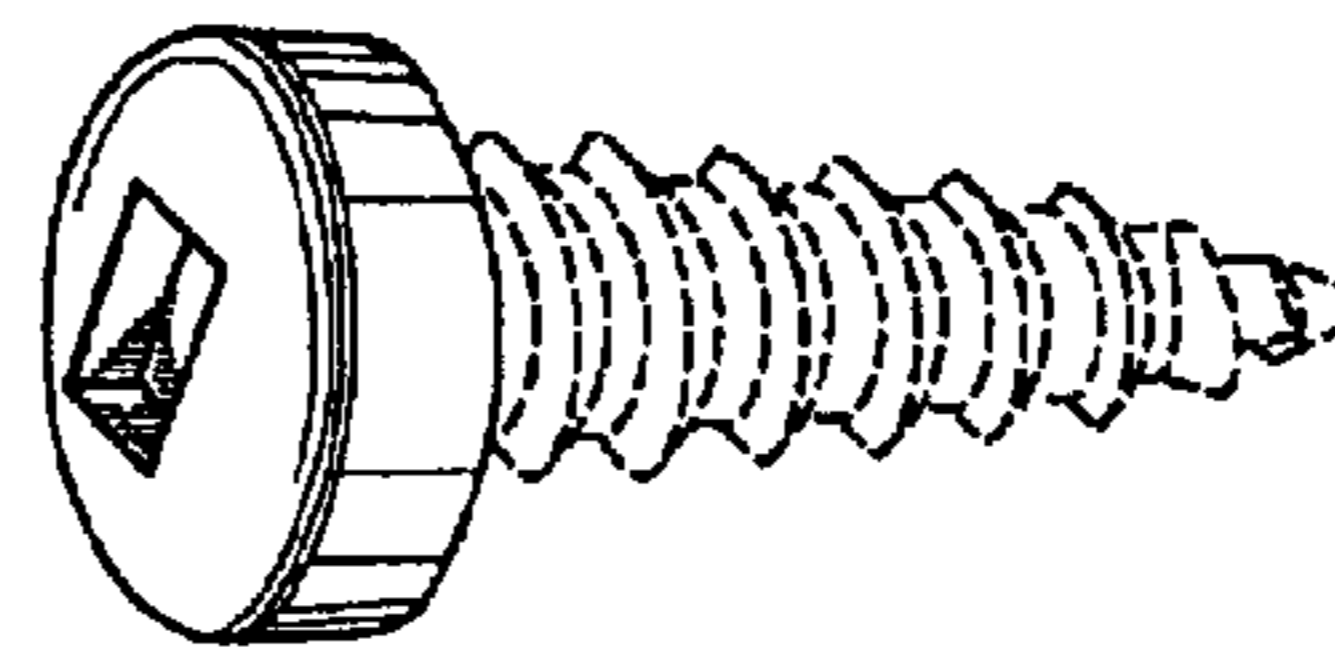

FIG. 13

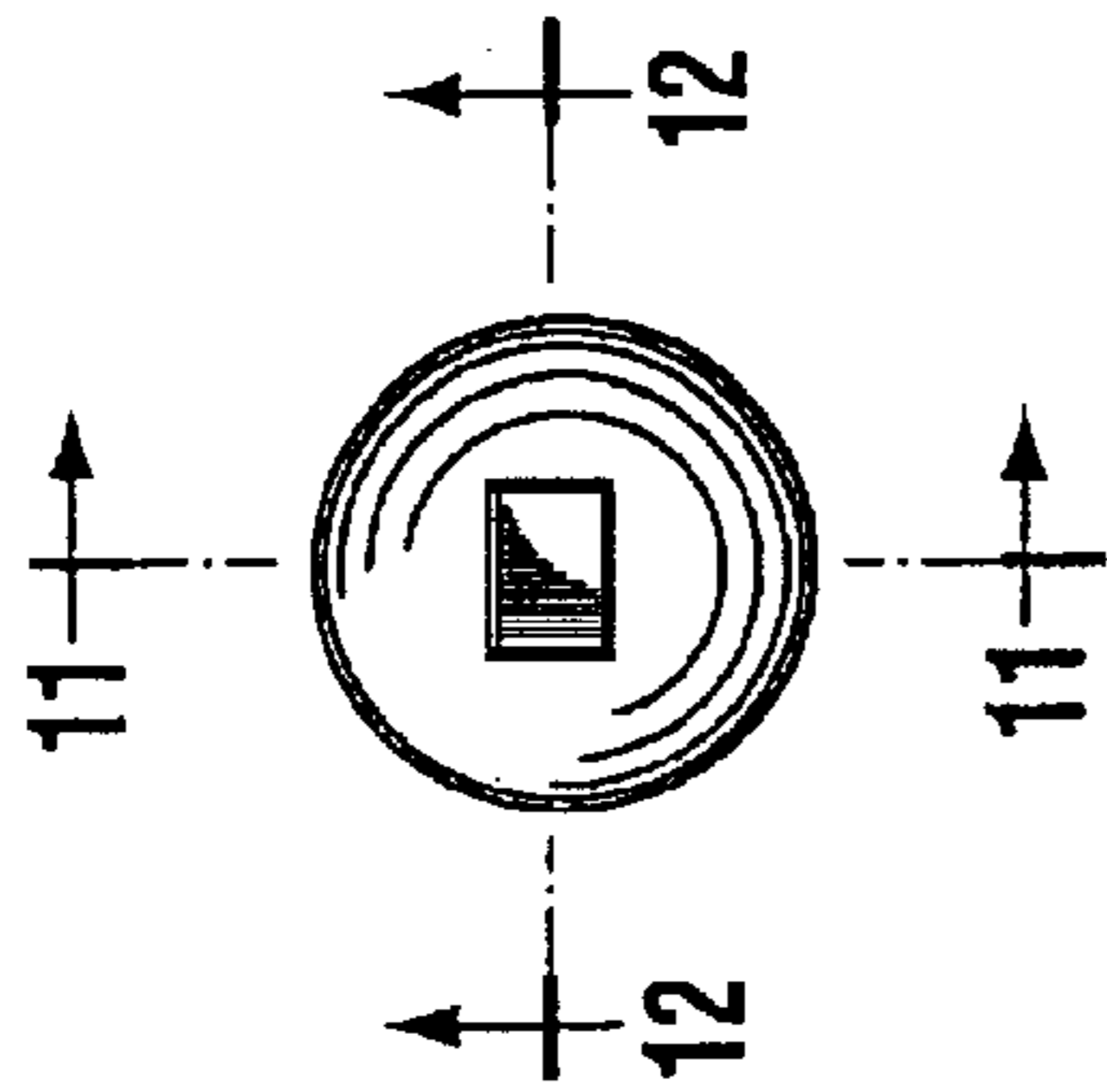

FIG. 10

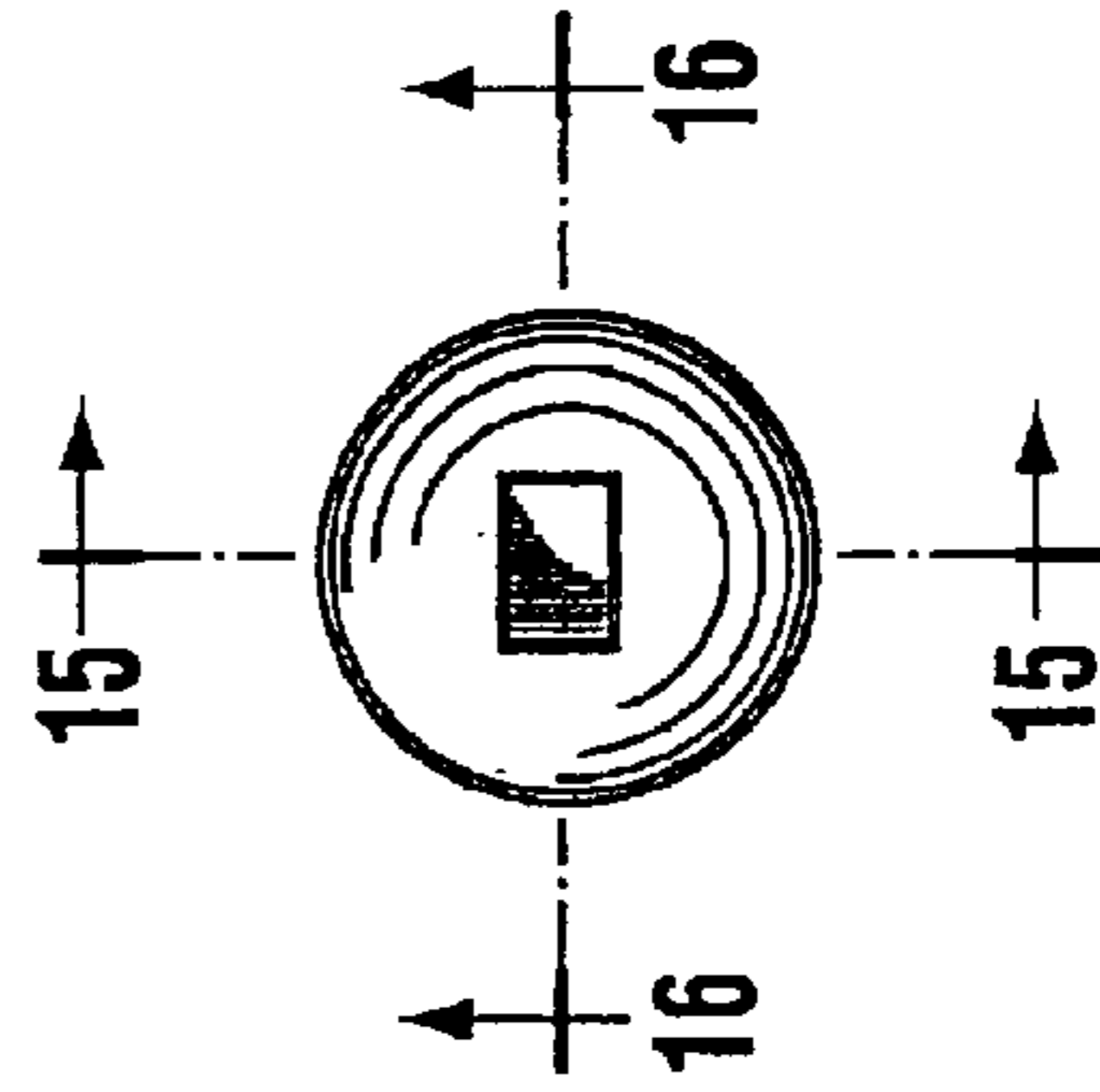

FIG. 14

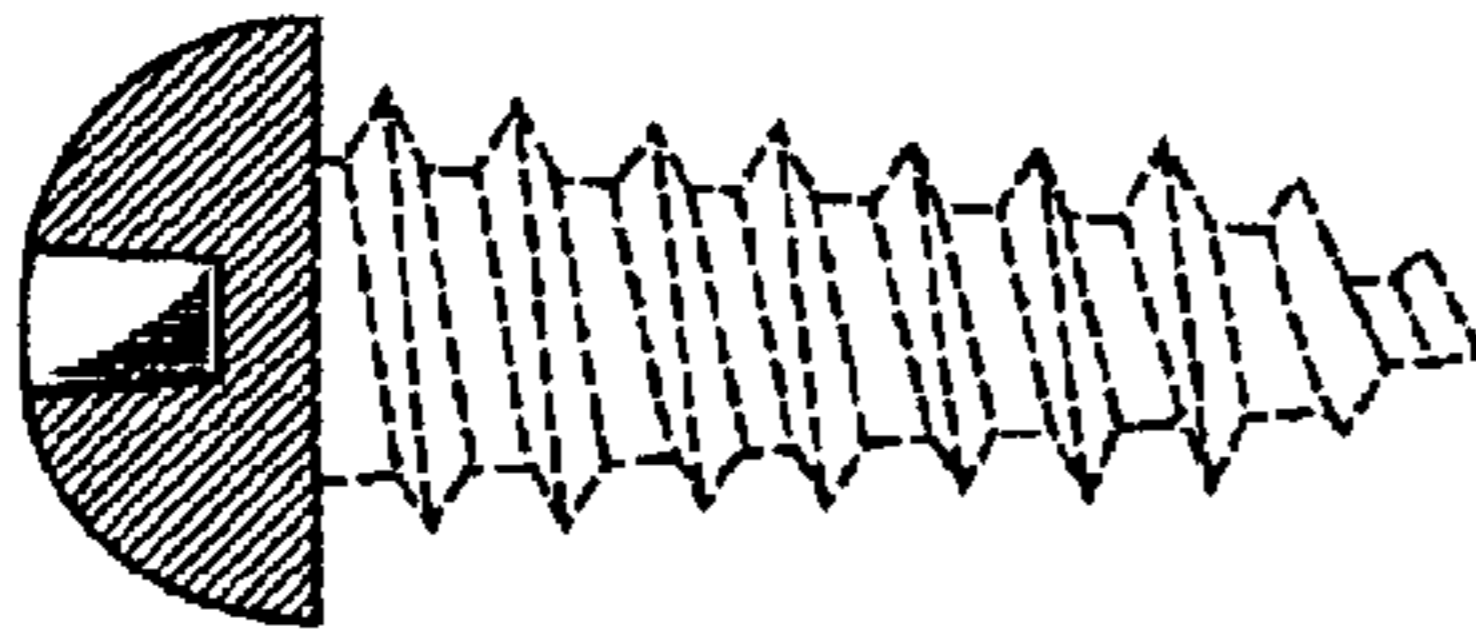

FIG. 11



FIG. 15



FIG. 12



FIG. 16