



US00D506851S

(12) **United States Design Patent**
Schmitz

(10) **Patent No.:** **US D506,851 S**
(45) **Date of Patent:** **** Jun. 28, 2005**

(54) **HAIR SETTER**

(75) Inventor: **Ingo Schmitz**, Duisburg (DE)

(73) Assignee: **WIK Far East Ltd.**, Hong Kong (CN)

(**) Term: **14 Years**

(21) Appl. No.: **29/186,811**

(22) Filed: **Jul. 22, 2003**

(30) **Foreign Application Priority Data**

Jan. 23, 2003 (DE) 403 00 496

(51) **LOC (8) Cl.** **28-03**

(52) **U.S. Cl.** **D28/35; D28/37; D28/38**

(58) **Field of Search** **D28/35, 37, 38;**
132/223-225, 229, 269, 271; 219/222, 225

(56) **References Cited**

U.S. PATENT DOCUMENTS

- D357,766 S * 4/1995 Prince et al. D28/38
- 5,749,379 A * 5/1998 Stillwagon et al. 219/222
- 6,554,000 B2 * 4/2003 Lin 132/232
- D479,625 S * 9/2003 Polisenno D28/35

* cited by examiner

Primary Examiner—Jennifer Rivard

(74) *Attorney, Agent, or Firm*—Margaret Polson Patent Law Offices of Rick Martin, P.C.

(57) **CLAIM**

The ornamental design for a hair setter, as shown and described.

DESCRIPTION

FIG. 1 is a front side elevation view of the case of my new design for a hair setter.

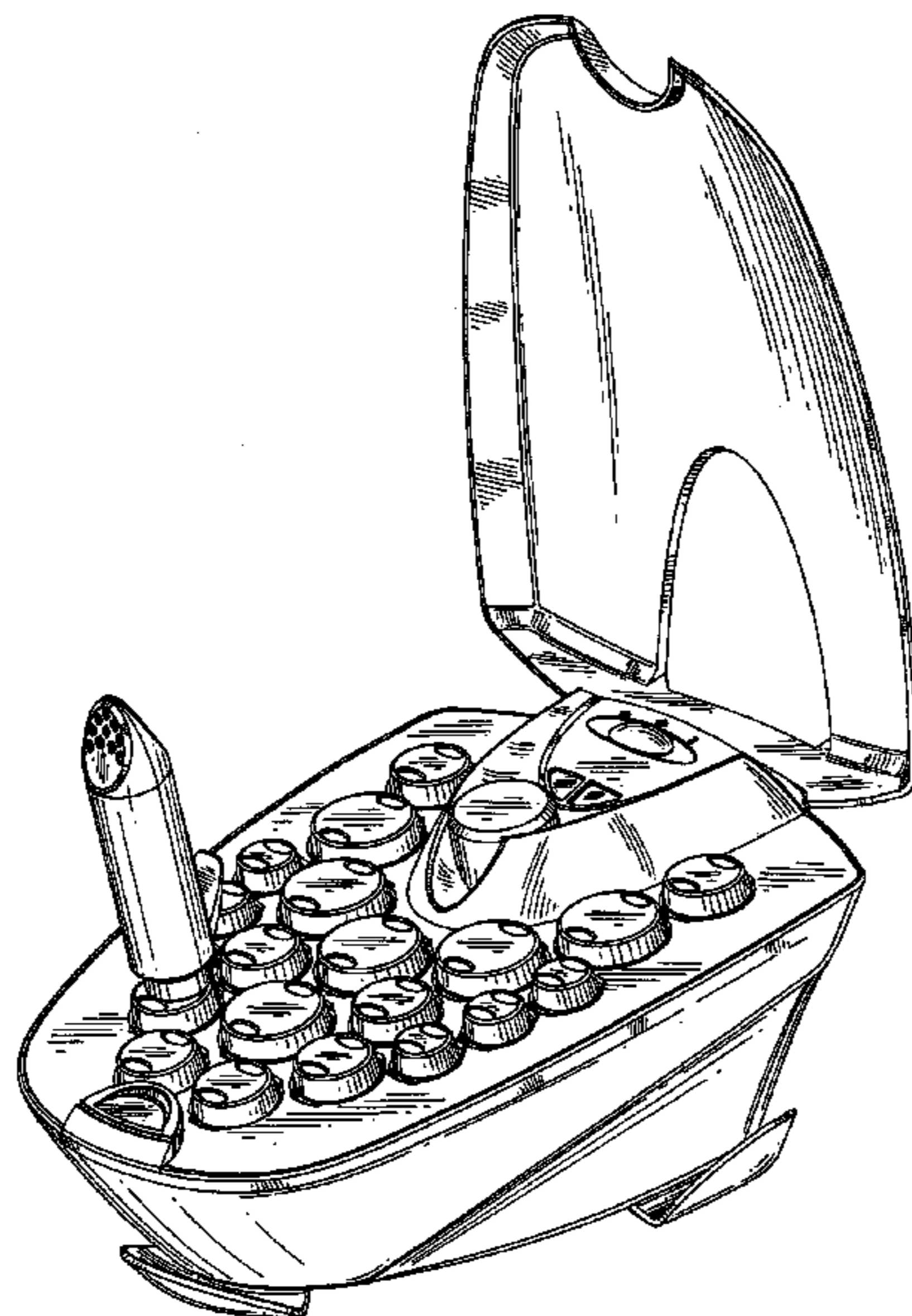

FIG. 2 is a rear side elevation view of FIG. 1.

FIG. 3 is a left side elevation view of FIG. 1.

FIG. 4 is a top plan view of FIG. 1.

FIG. 5 is a right side elevation view of FIG. 1.

FIG. 6 is a bottom plan view of FIG. 1.

FIG. 7 is a top perspective view of FIG. 1 with the lid open and the applicator wand inserted in a hair roller.

FIG. 8 is a top back perspective view of FIG. 1.

FIG. 9 is a top back perspective view of FIG. 1 with the applicator wand having been removed from its storage space, the arrow showing the insertion of the applicator wand.

FIG. 10 is a top plan view of the applicator wand of my new design.

FIG. 11 is a bottom plan view of FIG. 10.

FIG. 12 is a side elevation view of FIG. 10, the opposing side being a mirror image thereof.

FIG. 13 is a back side elevation view of FIG. 10.

FIG. 14 is front side elevation view of FIG. 10.

FIG. 15 is a top perspective view of FIG. 10, with a hair roller about to be slid on.

FIG. 16 is a top perspective view of FIG. 10, with a hair roller in place.

FIG. 17 is a side elevation view of the hair roller of my new design, all sides being identical; and,

FIG. 18 is a front side elevation view of FIG. 17, the back side elevation view being identical.

The applicator and hair roller are disclosed separately for convenience of illustration.

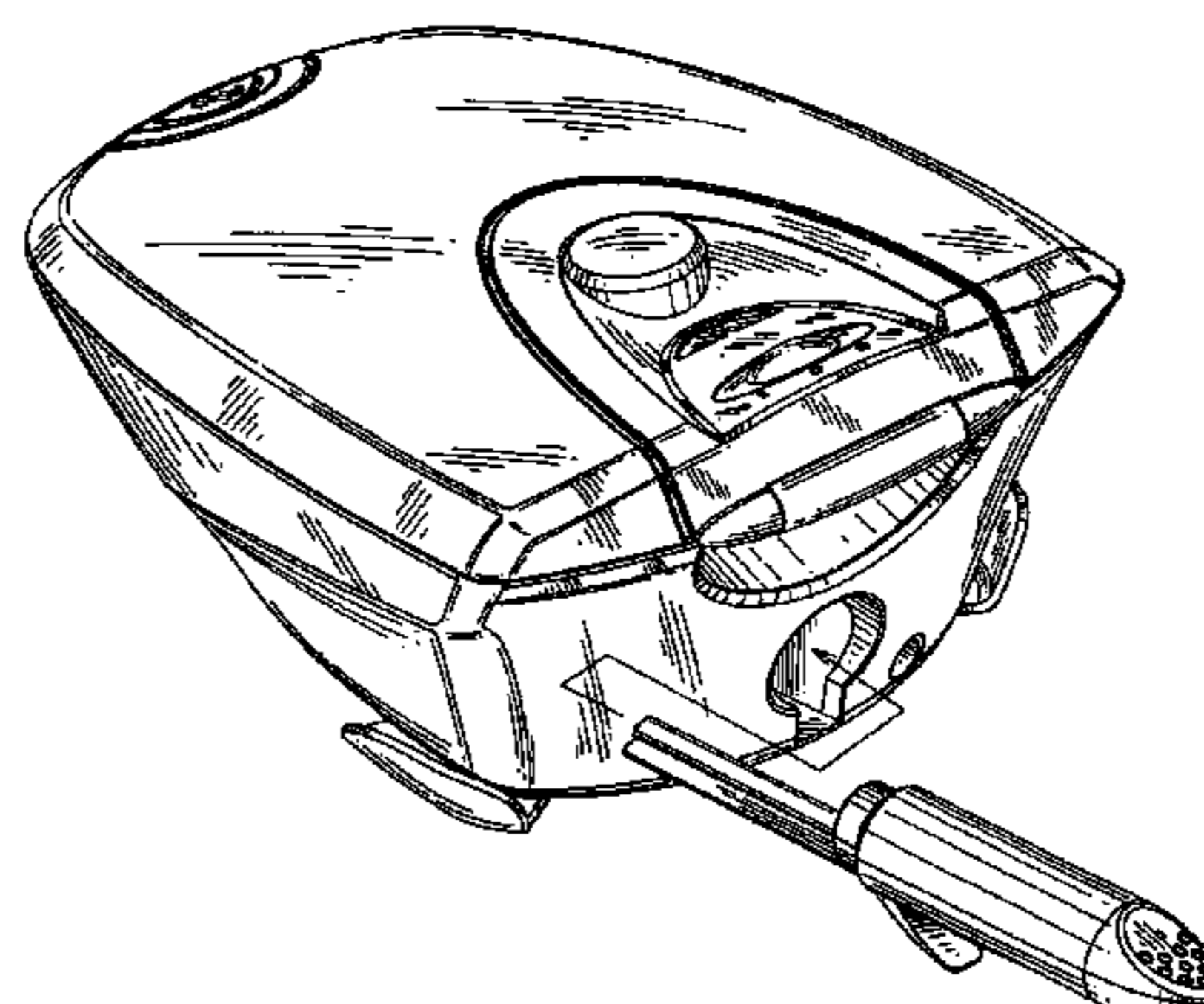

1 Claim, 6 Drawing Sheets

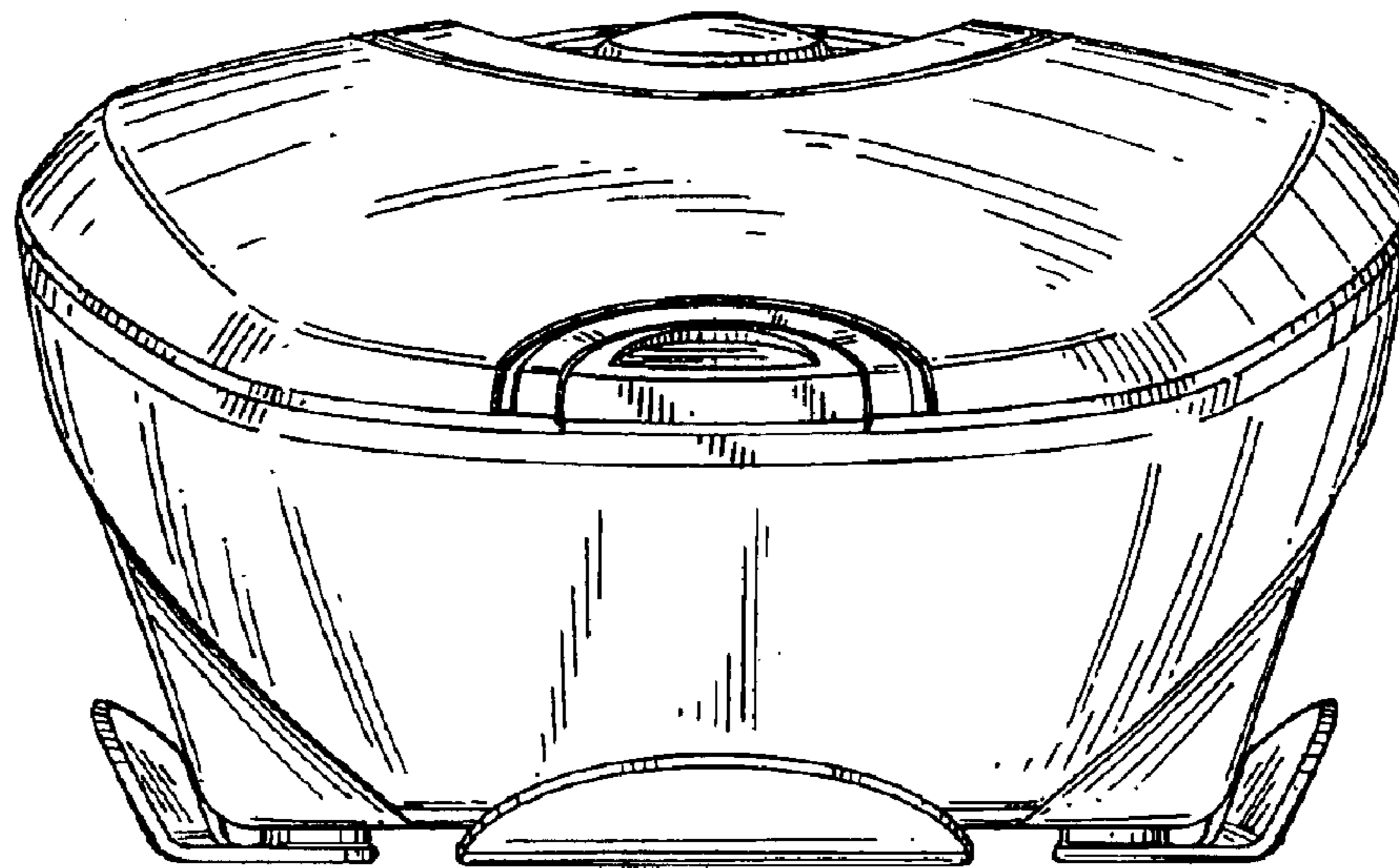

FIG. 1

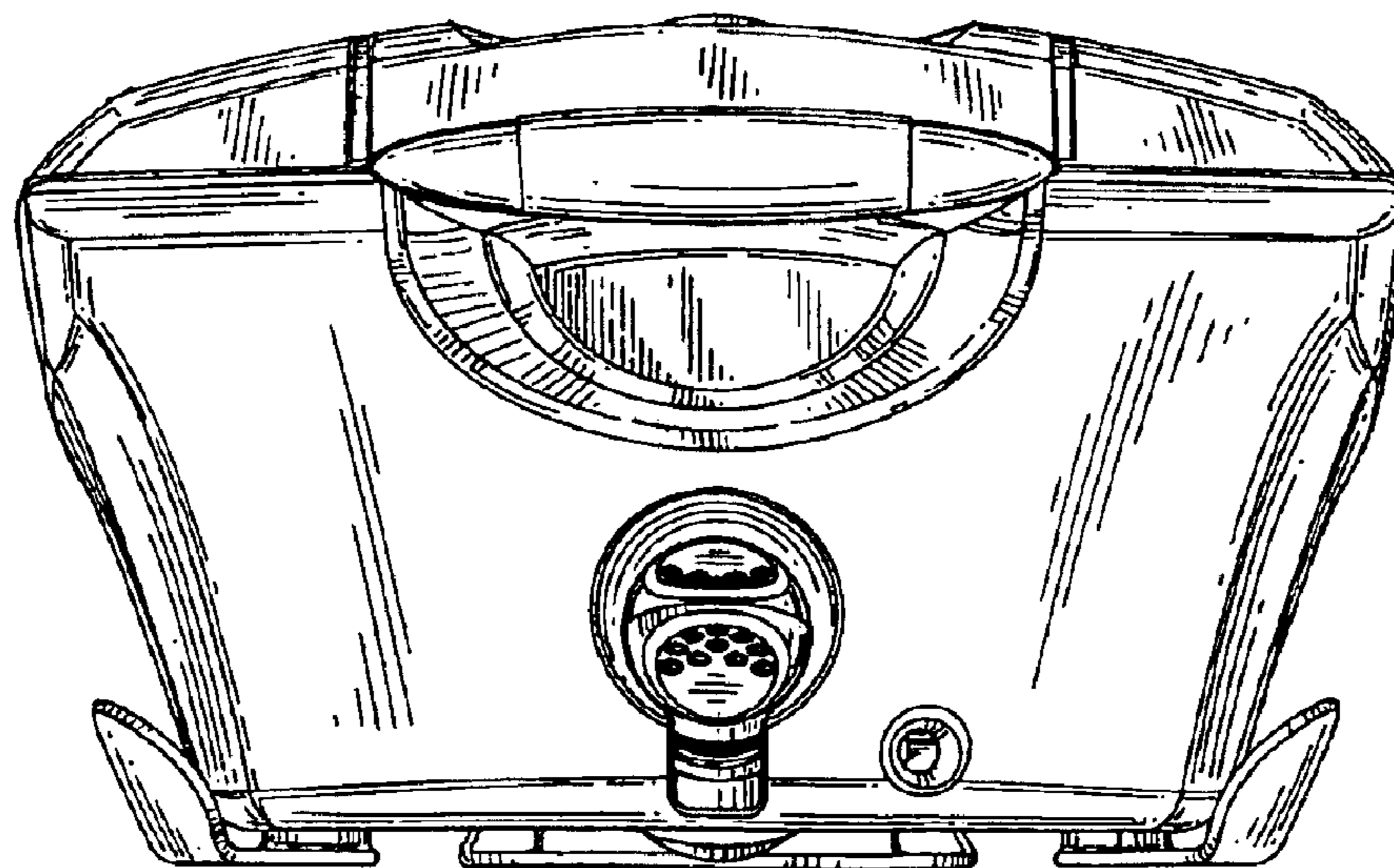

FIG. 2

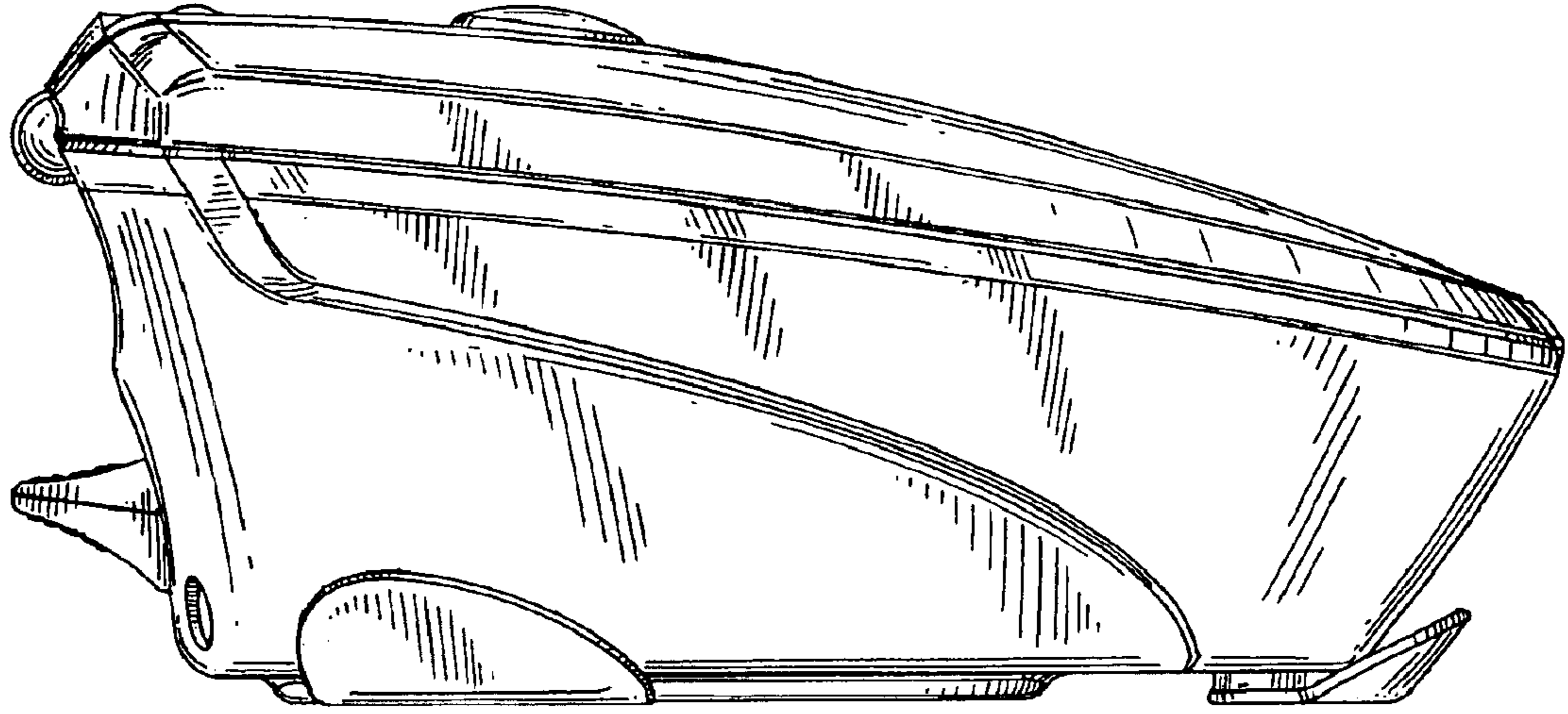

FIG. 3

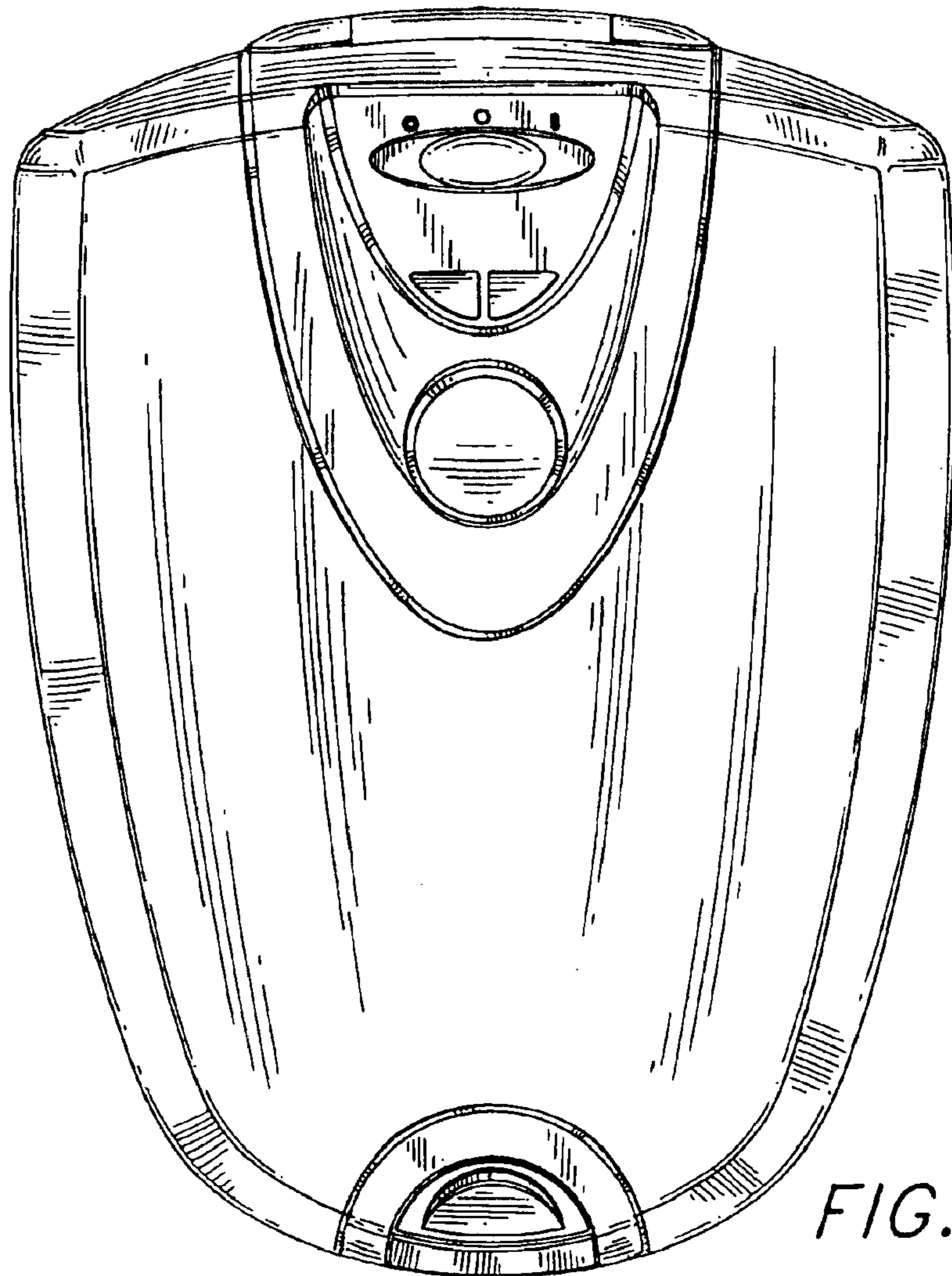

FIG. 4

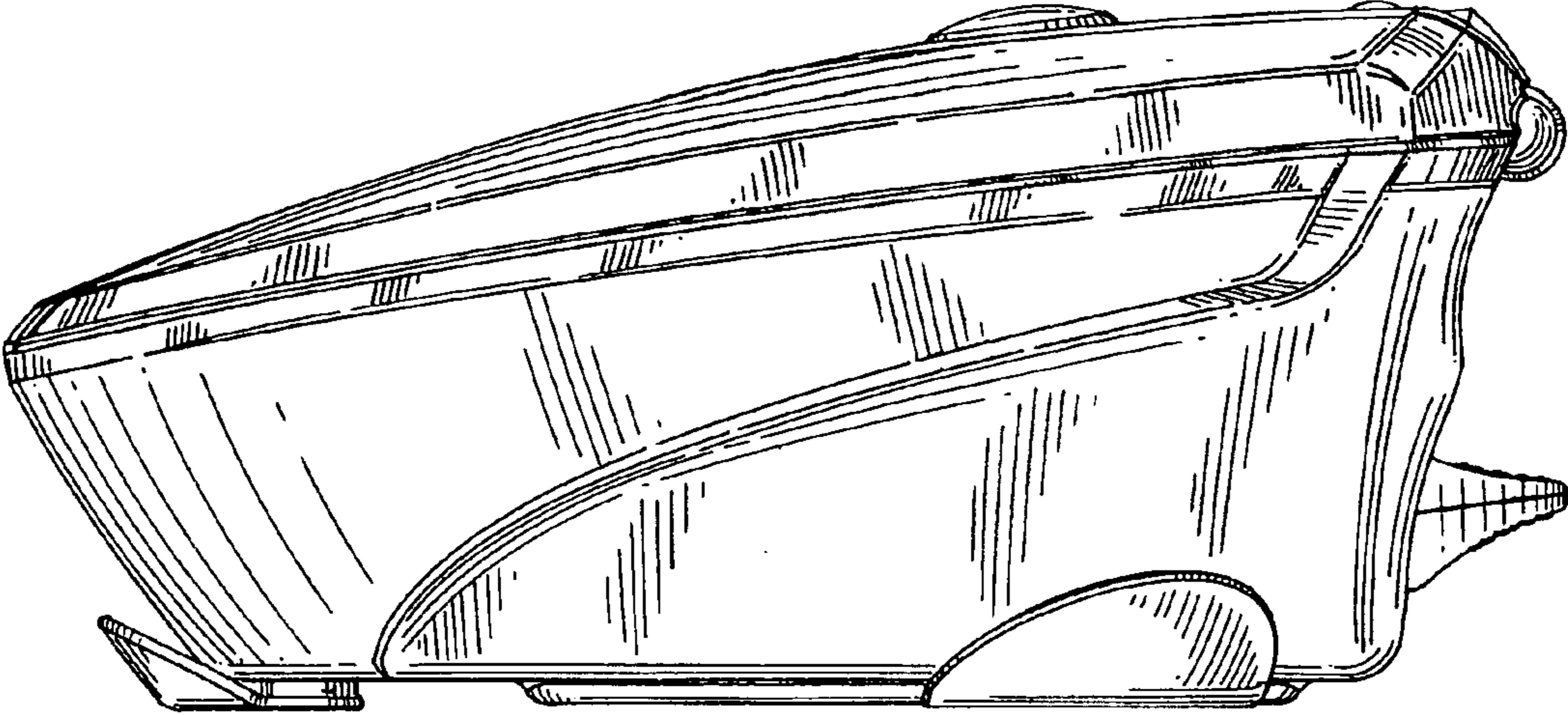

FIG. 5

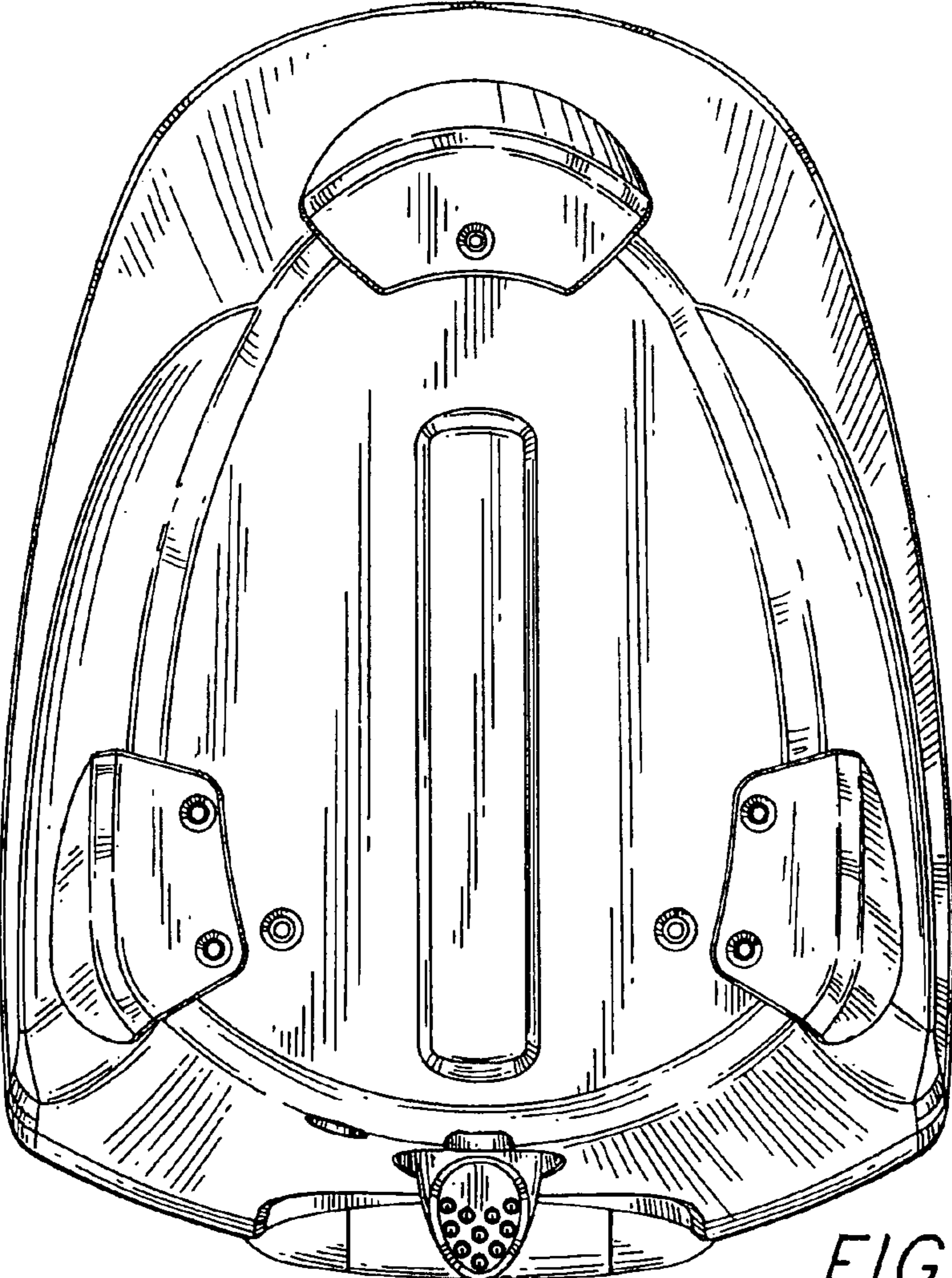

FIG. 6

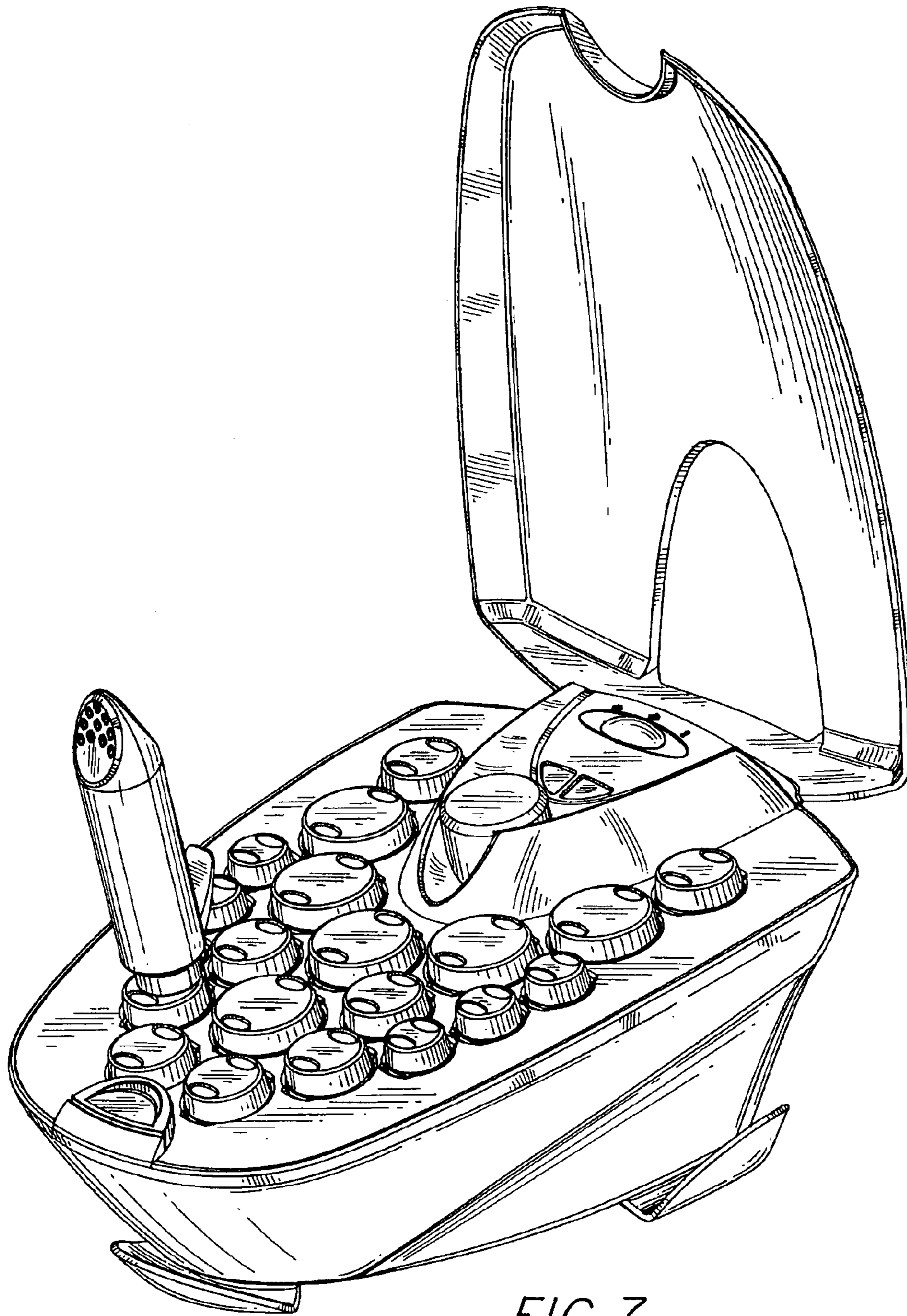

FIG. 7

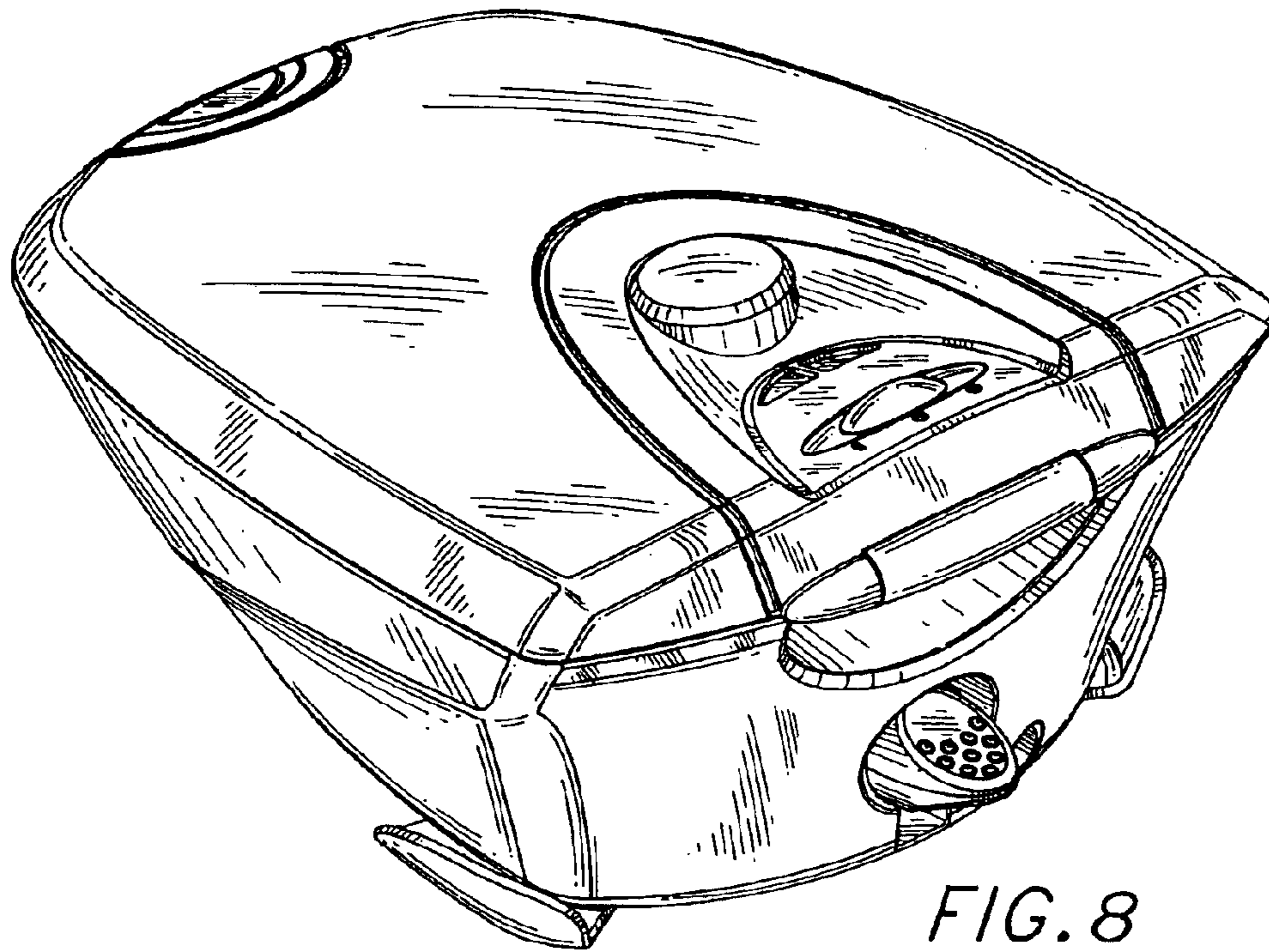

FIG. 8

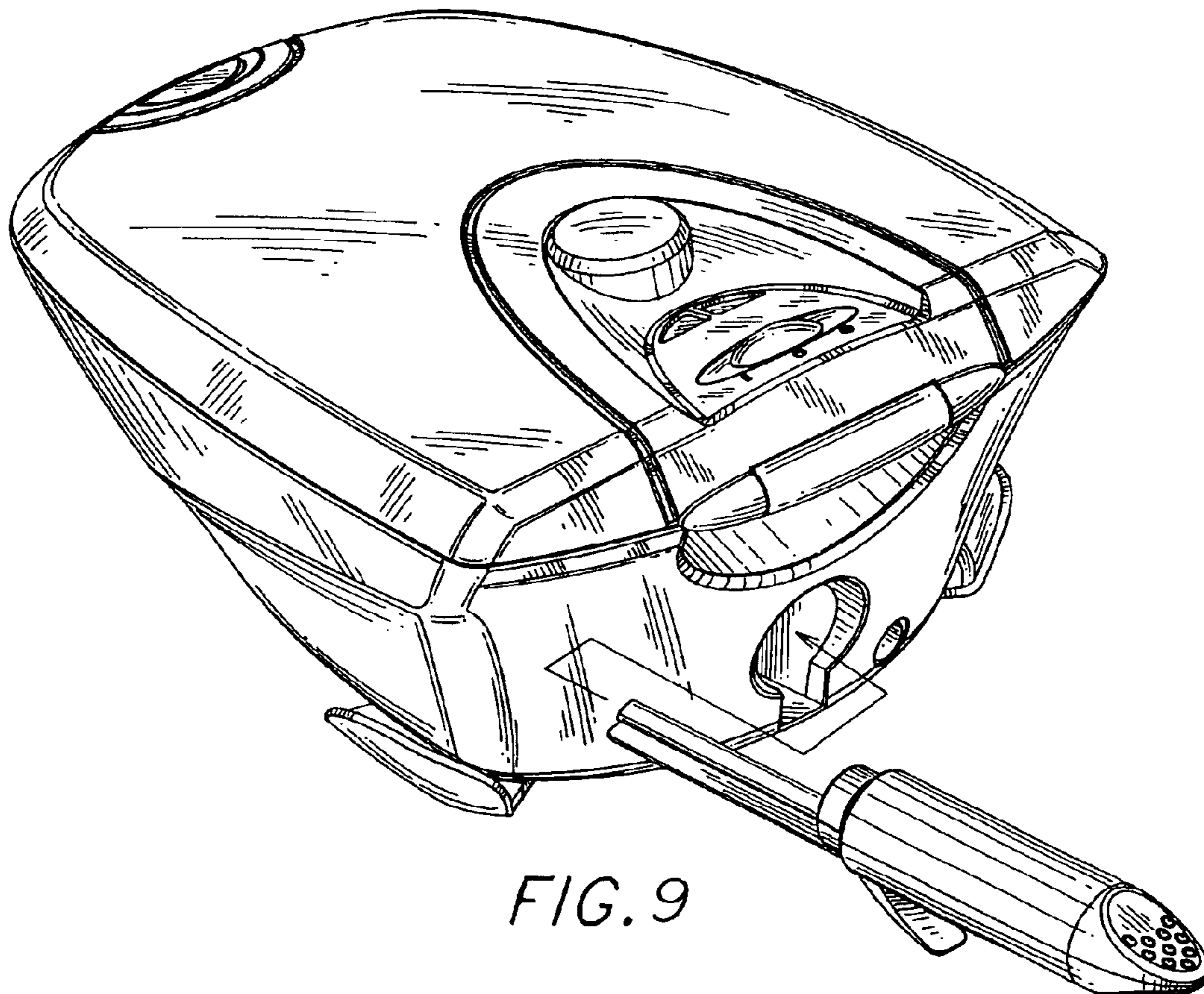

FIG. 9

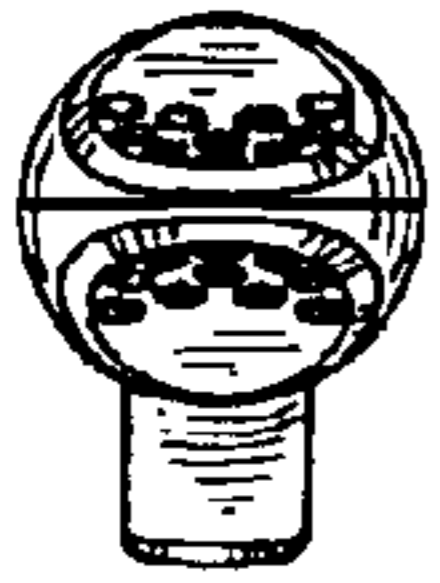

FIG. 13

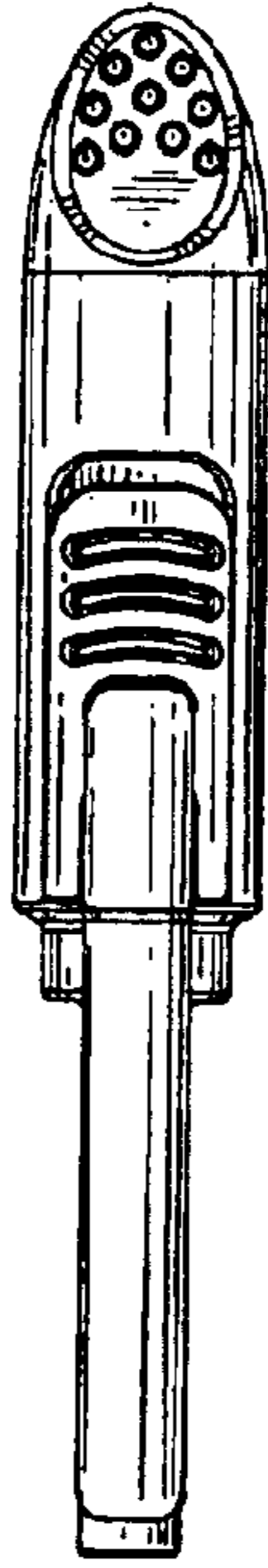

FIG. 10

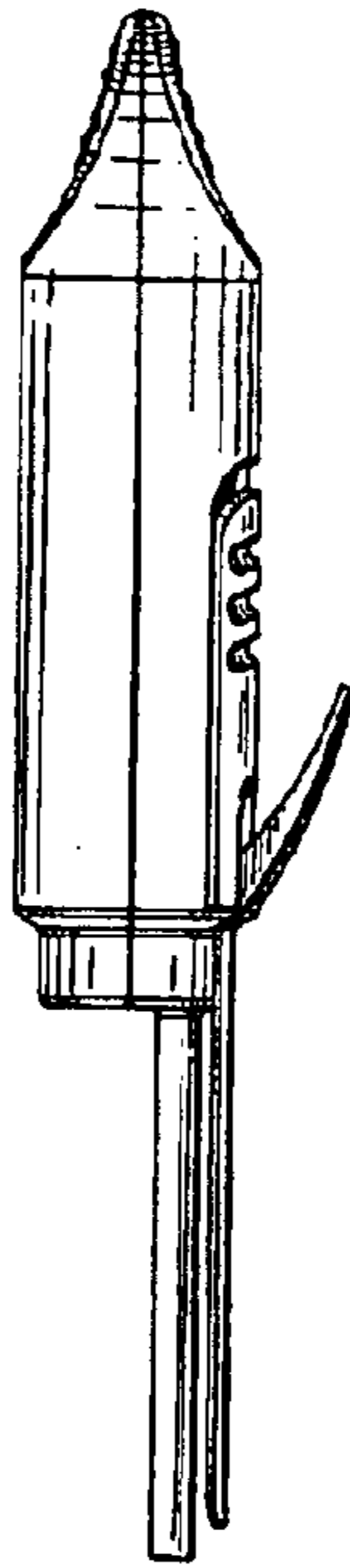

FIG. 12

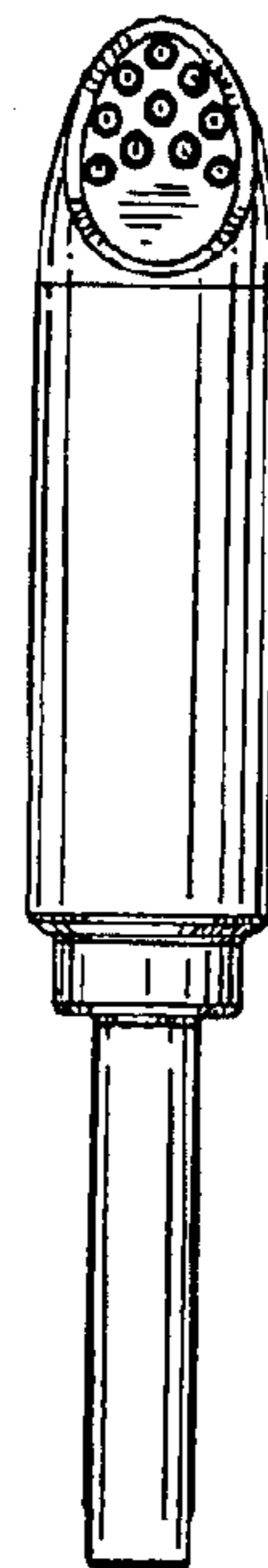

FIG. 11

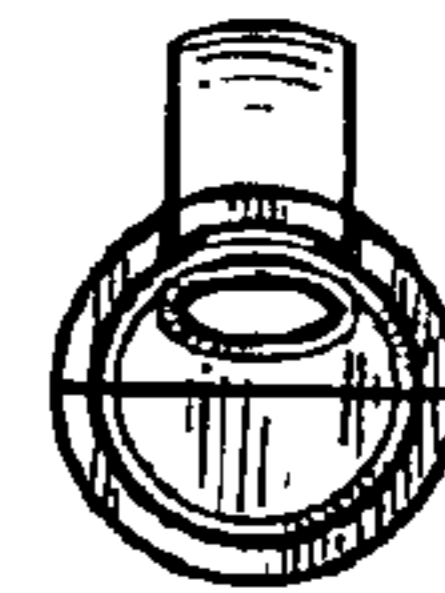

FIG. 14

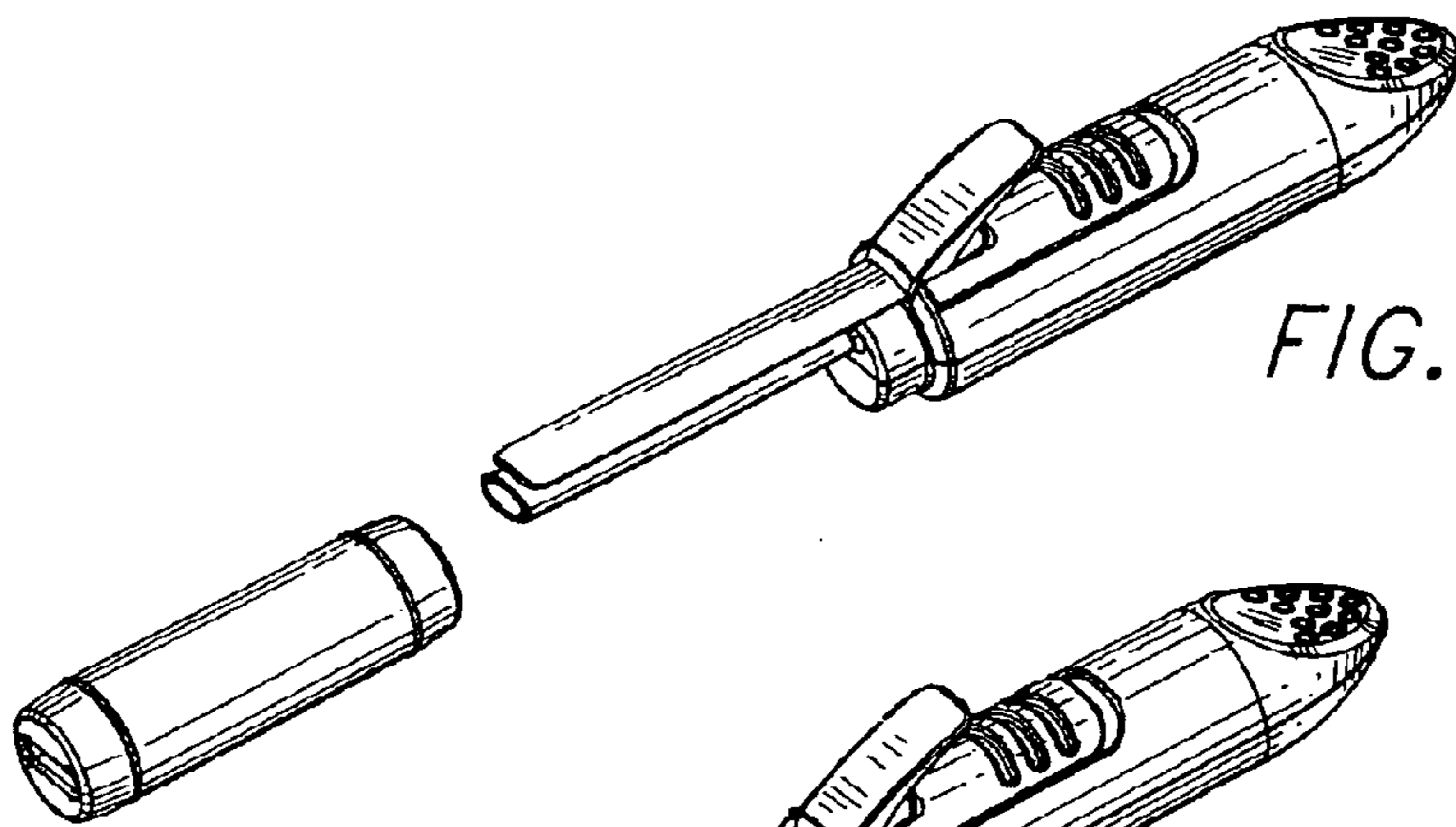

FIG. 15

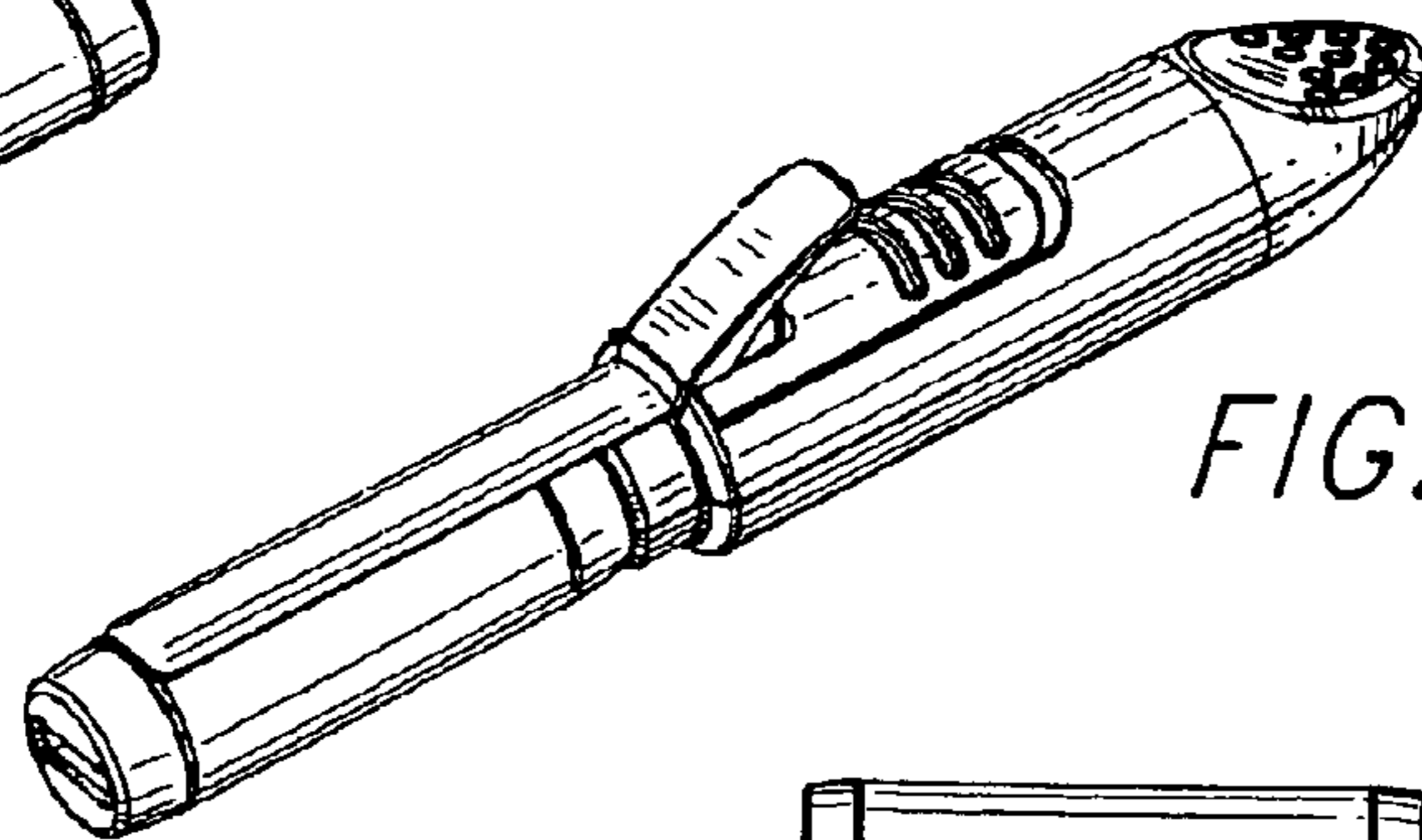

FIG. 16

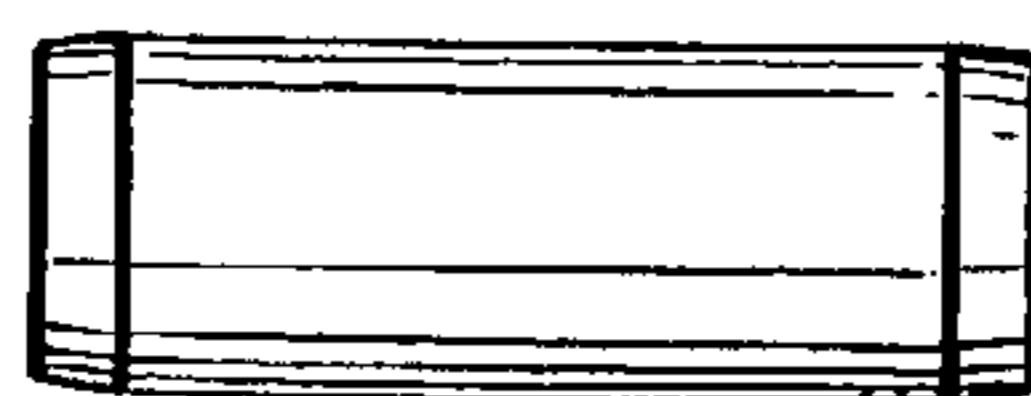

FIG. 17



FIG. 18