

US00D506546S

(12) **United States Design Patent**
Easom

(10) **Patent No.:** **US D506,546 S**
(45) **Date of Patent:** **** Jun. 21, 2005**

(54) **NASAL MASK WITH ELASTIC HEADBAND**

(75) **Inventor:** **John R. Easom**, Garfield, NJ (US)

(73) **Assignee:** **Vital Signs, Inc.**, Totowa, NJ (US)

(**) **Term:** **14 Years**

(21) **Appl. No.:** **29/194,227**

(22) **Filed:** **Nov. 20, 2003**

(51) **LOC (8) Cl.** **29-02**

(52) **U.S. Cl.** **D24/110.1; D24/110.4**

(58) **Field of Search** **D24/110.1, 110.4,**
D24/110.5; 128/207.11, 207.17, 207.13,
206.21, 206.28

(56) **References Cited**

U.S. PATENT DOCUMENTS

- 3,599,636 A * 8/1971 Gutman et al. 128/207.11
- 5,628,308 A * 5/1997 Harges et al. 128/206.21

6,494,207 B1 * 12/2002 Kwok 128/207.11

* cited by examiner

Primary Examiner—Ian Simmons

(74) *Attorney, Agent, or Firm*—R. Gale Rhodes, Jr.

(57) **CLAIM**

I claim the ornamental design for the nasal mask with elastic headband, as shown and described.

DESCRIPTION

FIG. 1 is a top left side perspective view of a nasal mask with an elastic headband showing my new design; FIG. 2 is a front upper perspective view thereof; FIG. 3 is a top view thereof; FIG. 4 is a bottom view thereof; FIG. 5 is a rear view thereof; FIG. 6 is a front view thereof; FIG. 7 is a right side view thereof; and, FIG. 8 is a left side view thereof.

1 Claim, 4 Drawing Sheets

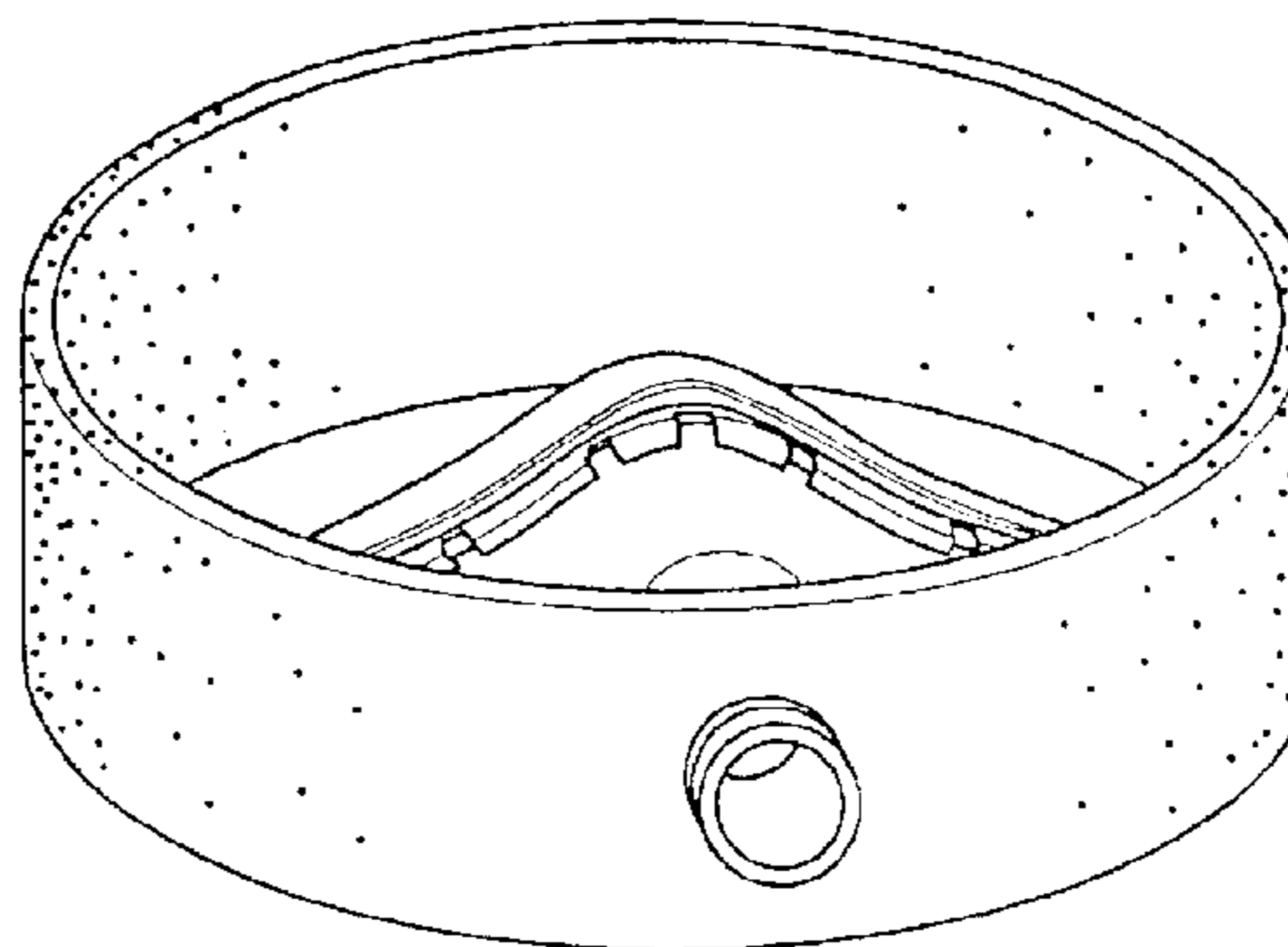
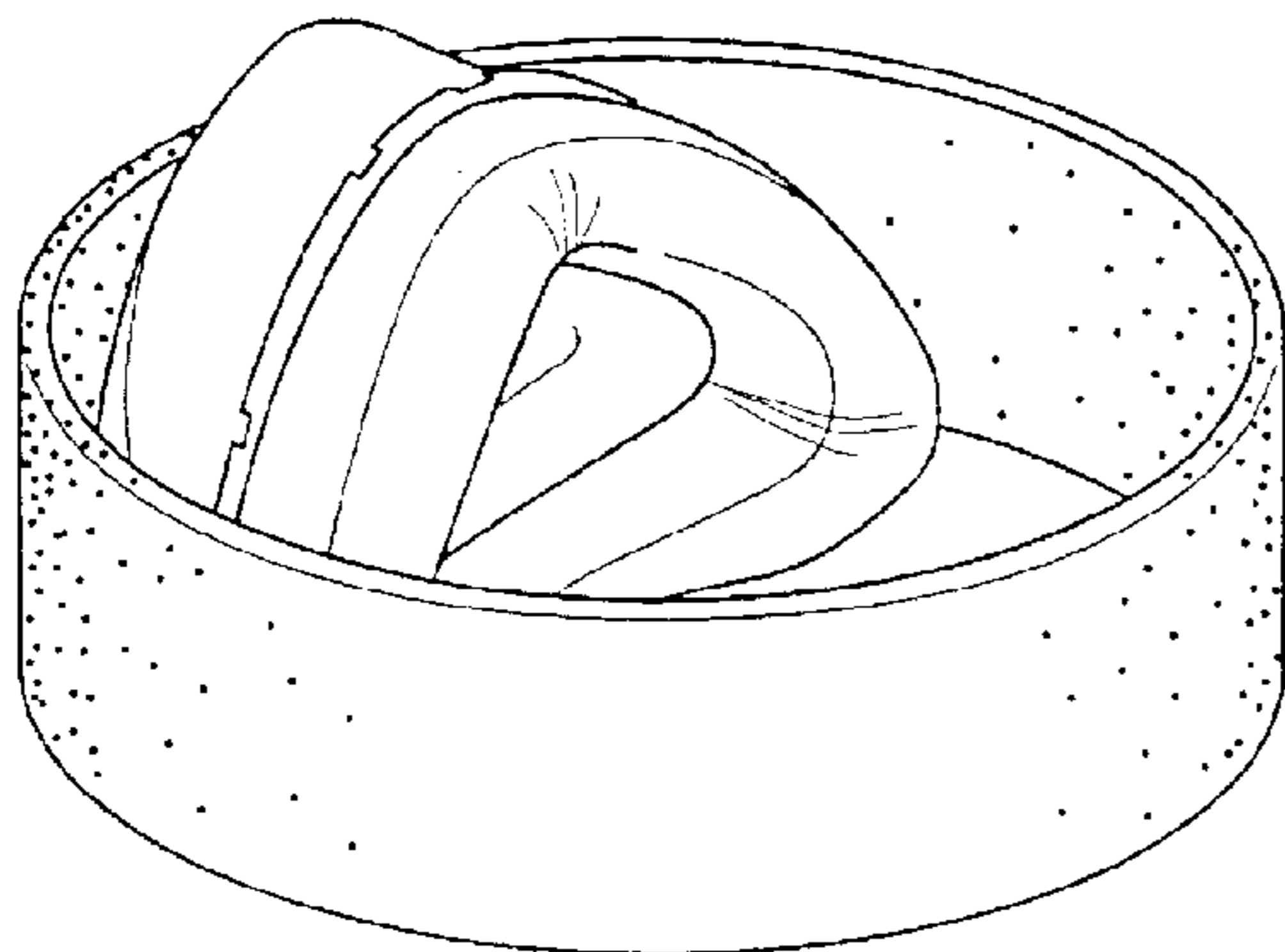

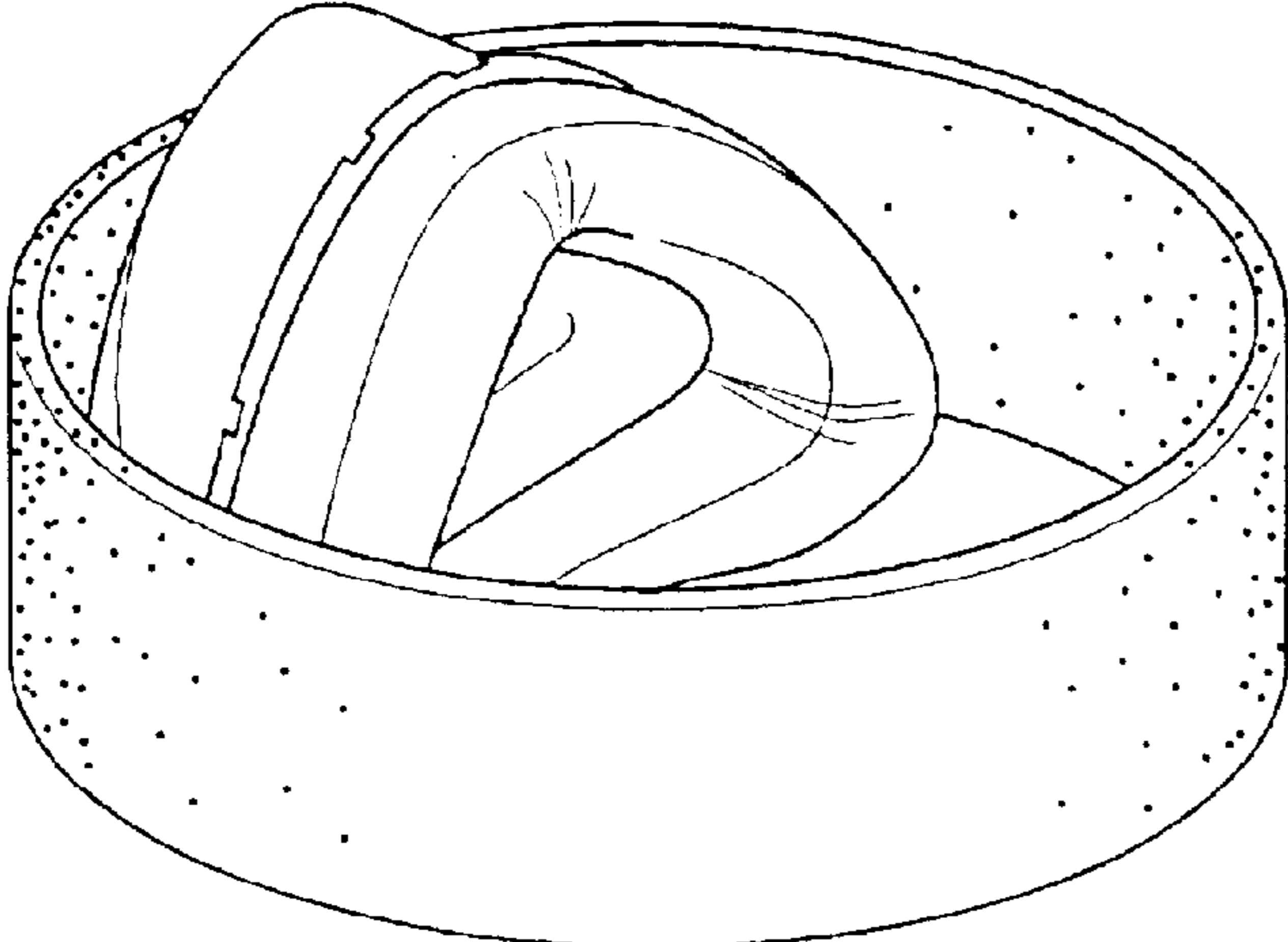

FIG. 1

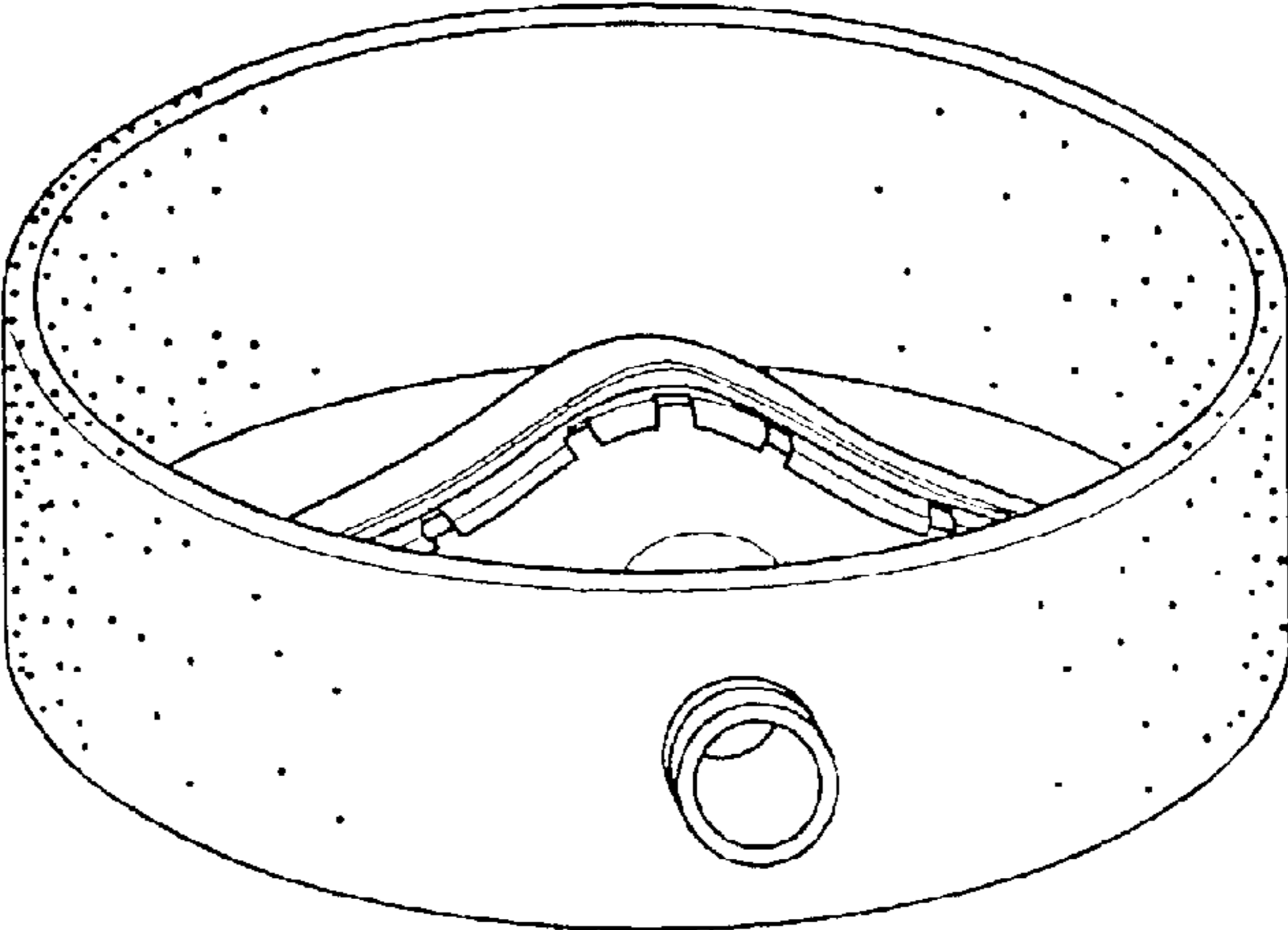

FIG. 2

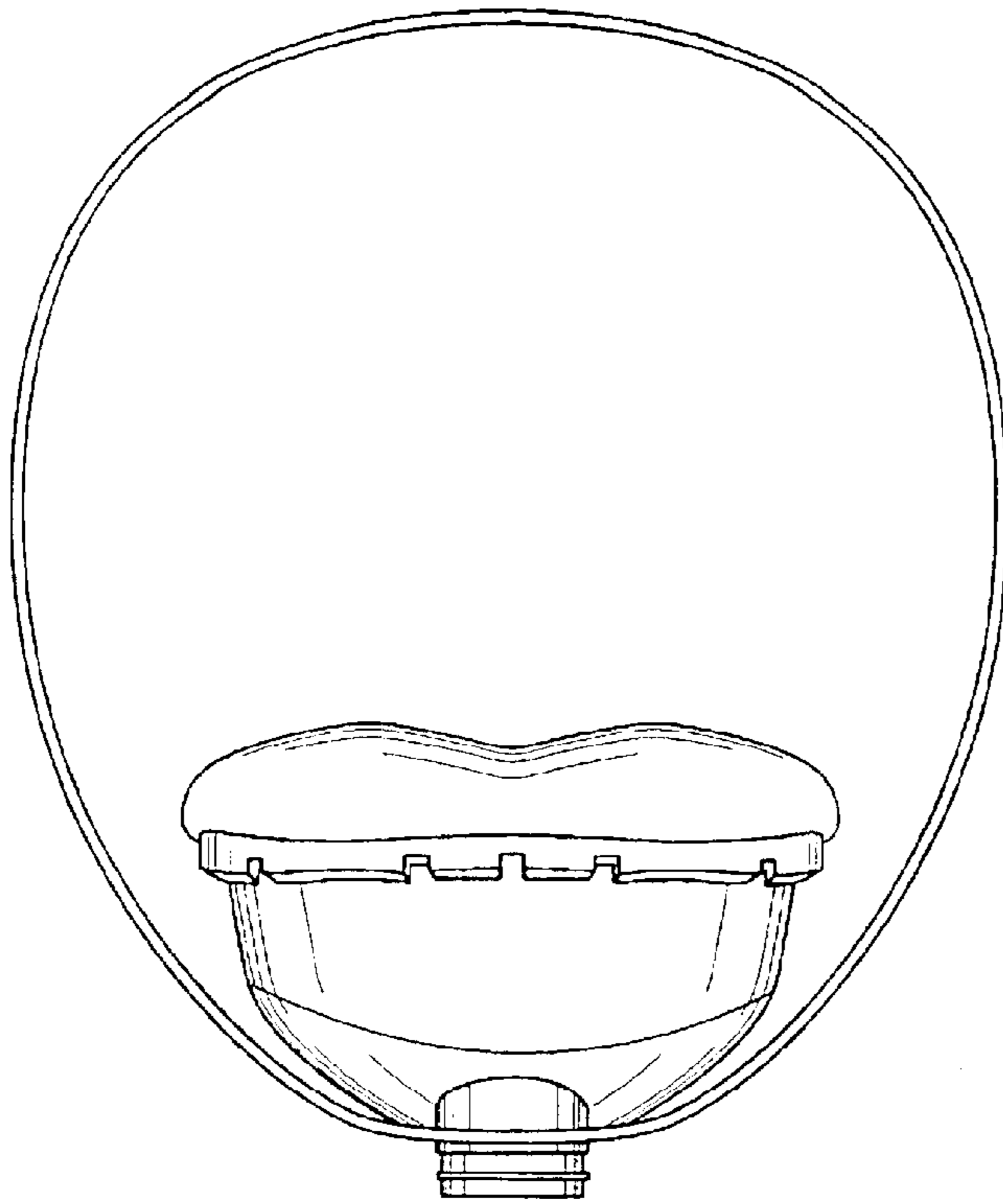

FIG. 3

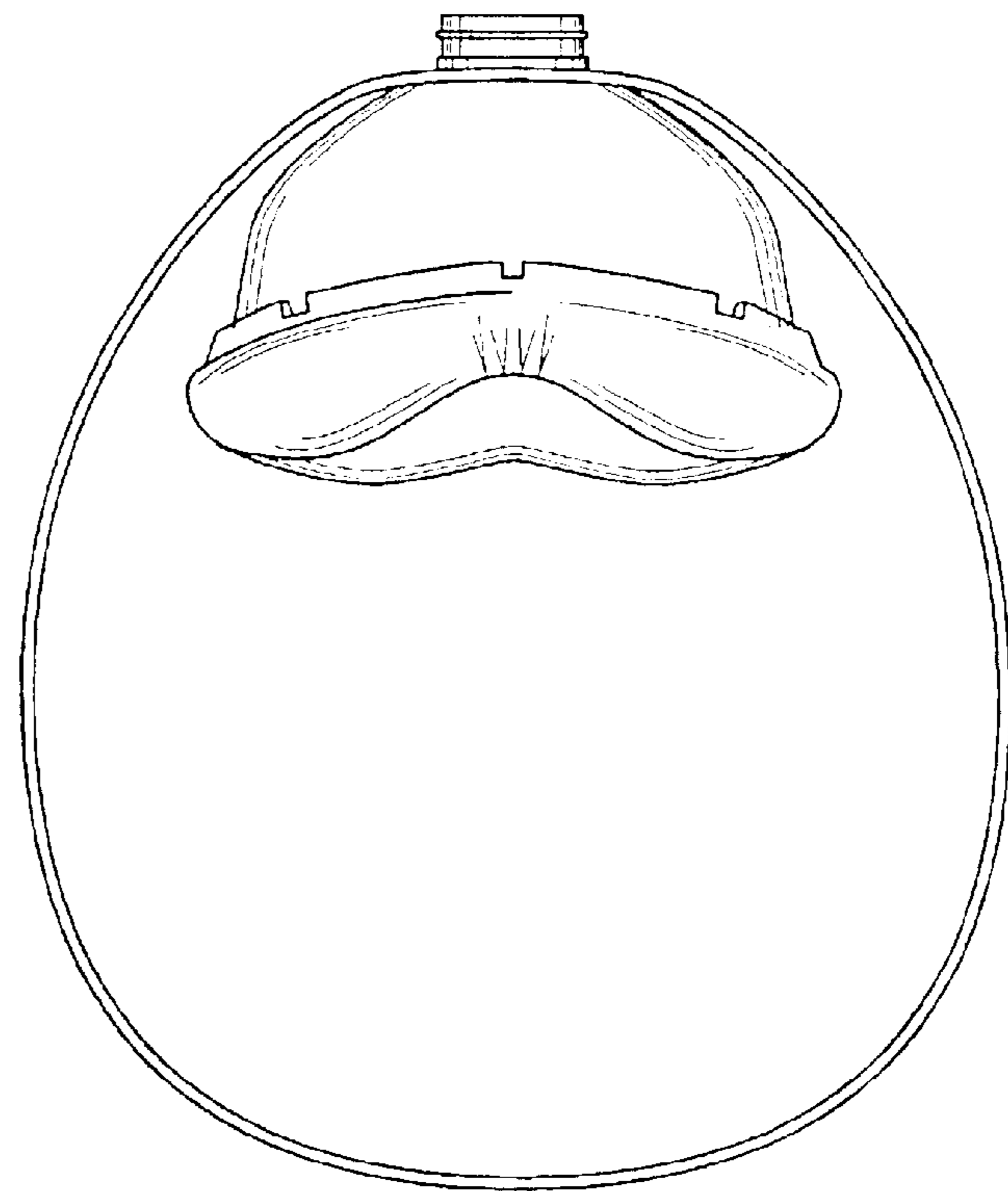

FIG. 4

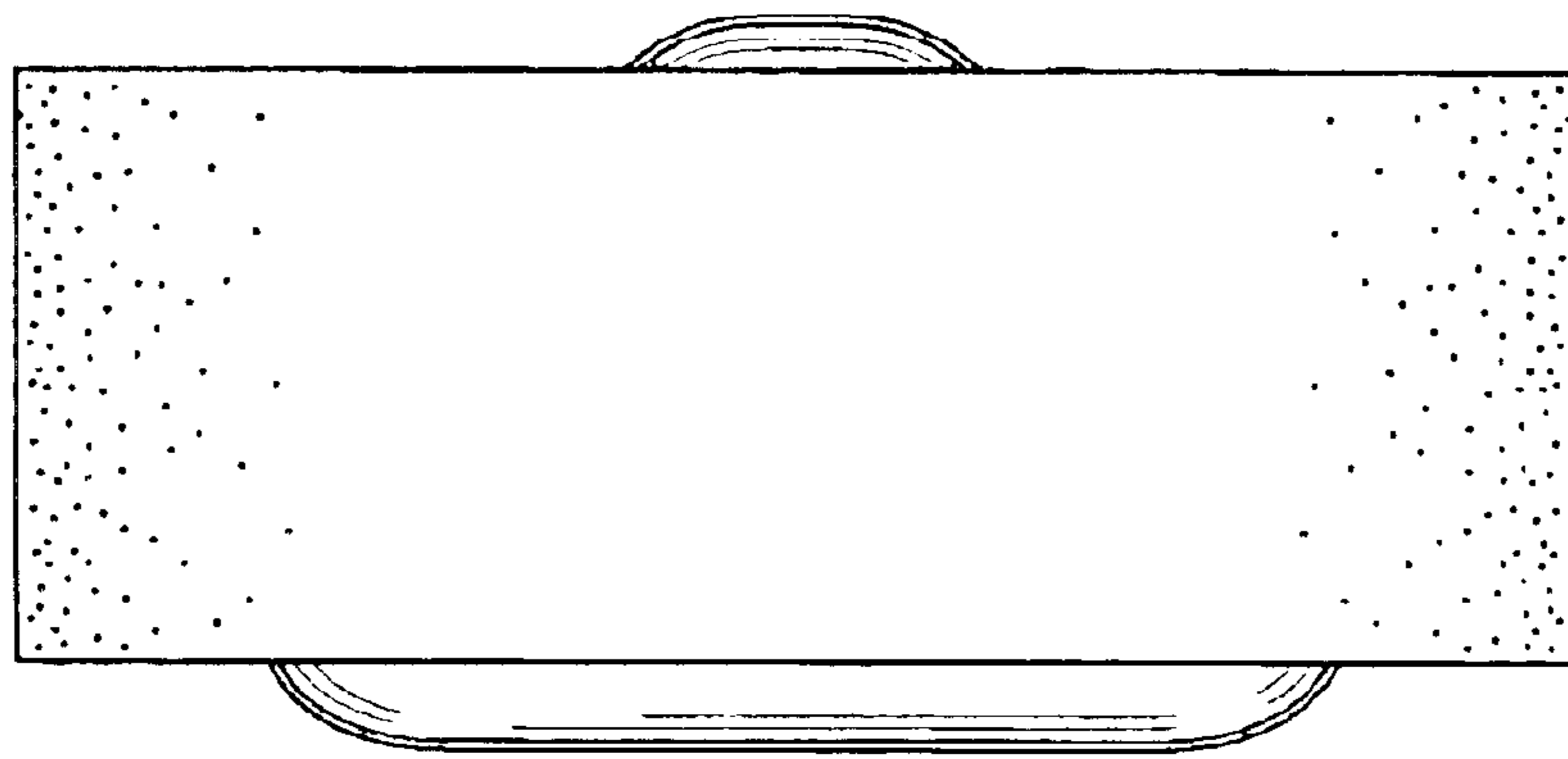

FIG. 5

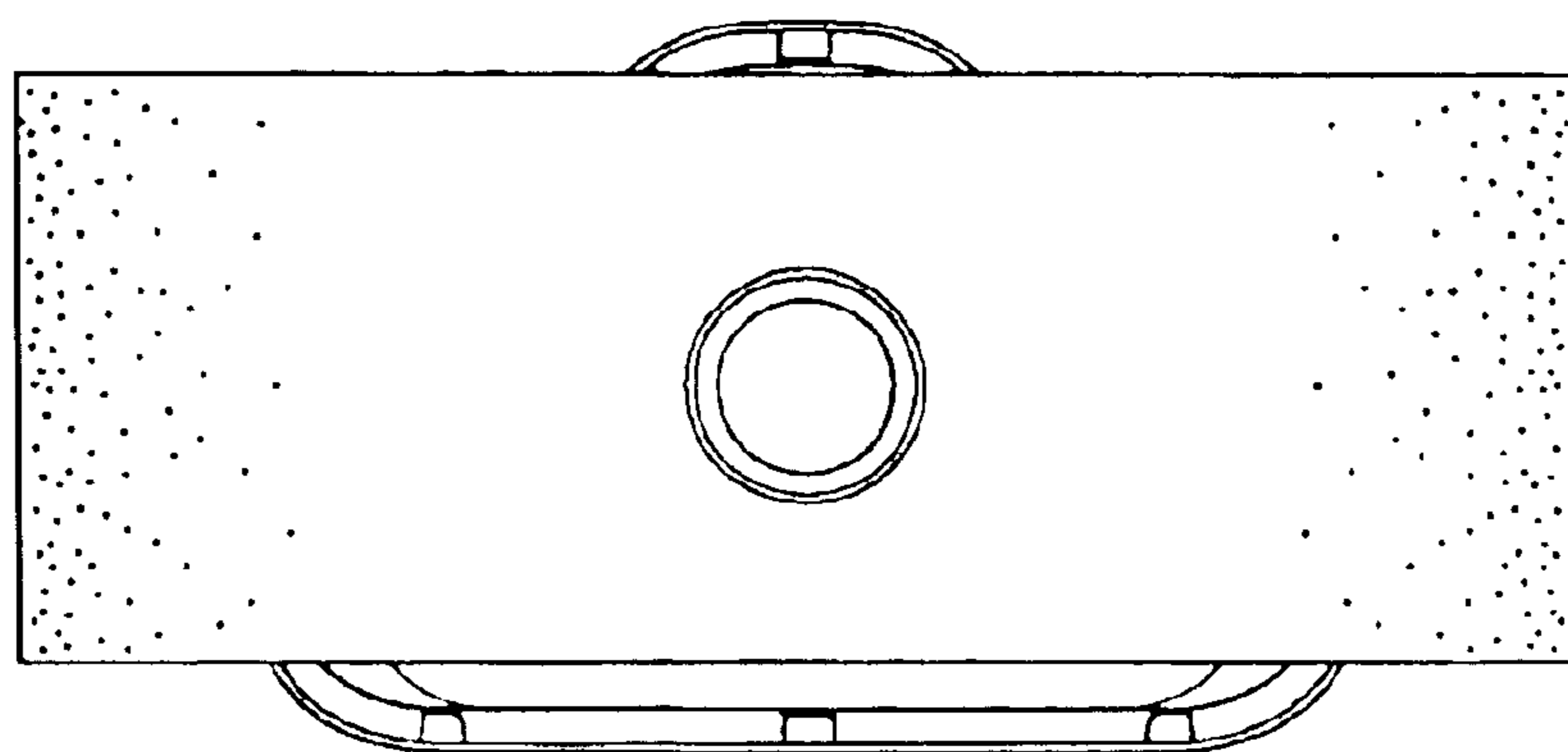

FIG. 6

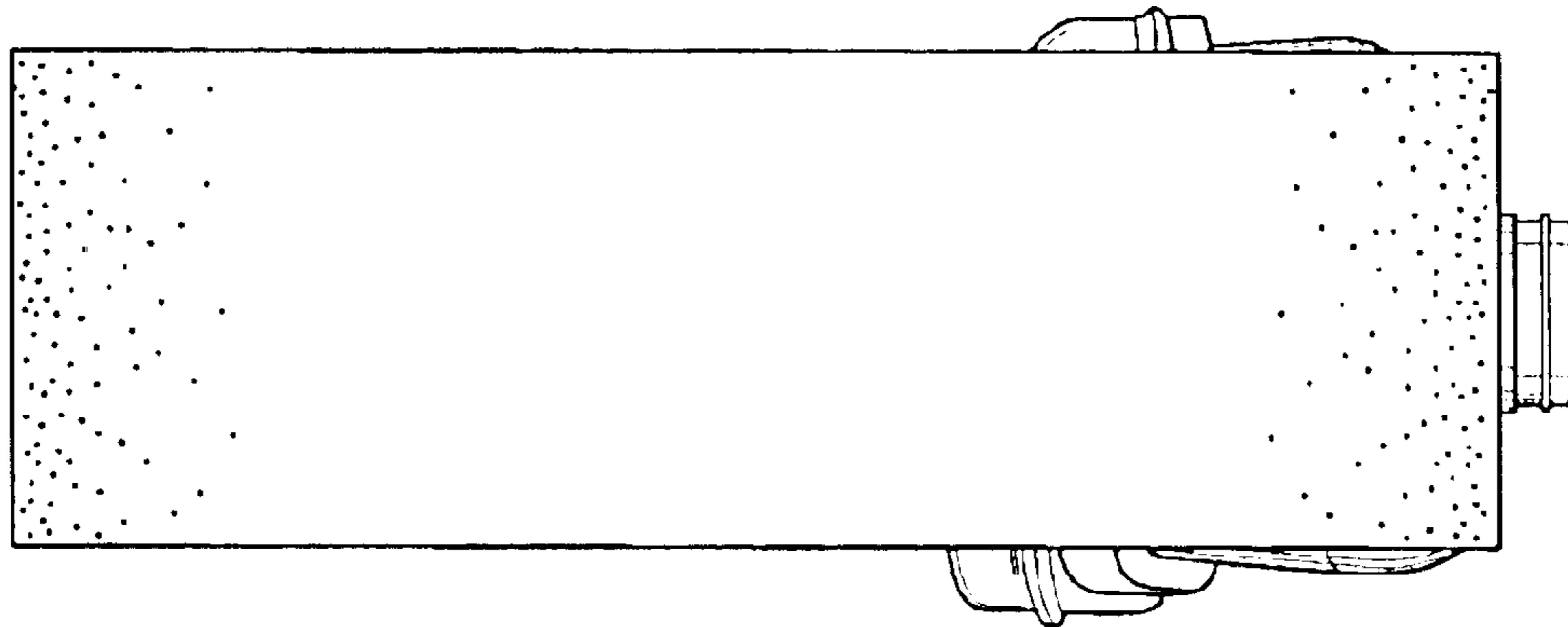

FIG. 7

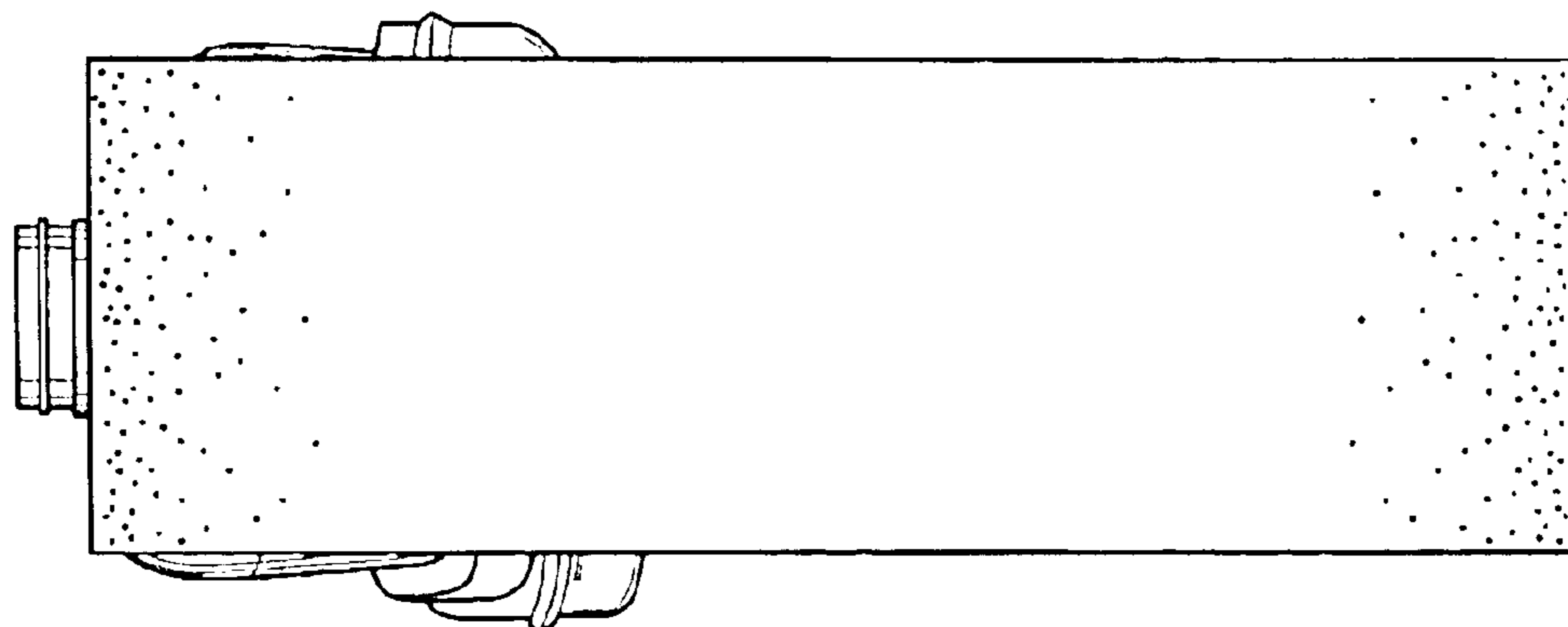

FIG. 8