

US00D506480S

(12) **United States Design Patent** (10) **Patent No.:** **US D506,480 S**  
**Floeter, Jr. et al.** (45) **Date of Patent:** **\*\* Jun. 21, 2005**

(54) **SHELF FOR REFRIGERATOR DOOR**

(75) Inventors: **Rodolfo Floeter, Jr.**, Joinville-SC (BR);  
**Edson Isaltino Bento**, Aventureiro  
Joinville-SC (BR); **Ricardo Kolb Filho**,  
Joinville-SC (BR); **Guilherme Nehring**,  
Joinville-SC (BR); **Nilton Santo**  
**Tirotti**, Costa e Silva Joinville-SC (BR)

(73) Assignee: **Multibras S.A. Eletrodomesticos**,  
Sao-Paulo (BR)

(\*\*) Term: **14 Years**

(21) Appl. No.: **29/195,930**

(22) Filed: **Dec. 17, 2003**

(30) **Foreign Application Priority Data**

Jun. 17, 2003 (BR) ..... DI 6302067

(51) **LOC (8) Cl.** ..... **15-07**

(52) **U.S. Cl.** ..... **D15/89**

(58) **Field of Search** ..... D15/79-91; 211/71,  
211/74, 75, 88, 90, 113, 126, 153; 248/309.1;  
312/128.32, 401, 402, 408

(56) **References Cited**

**U.S. PATENT DOCUMENTS**

D344,739 S \* 3/1994 Edman et al. .... D15/89  
5,567,029 A \* 10/1996 Haenisch et al. .... 312/405.1  
D494,195 S \* 8/2004 Becke ..... D15/89

\* cited by examiner

*Primary Examiner*—Mitchell Siegel

(74) *Attorney, Agent, or Firm*—Abelman, Frayne & Schwab

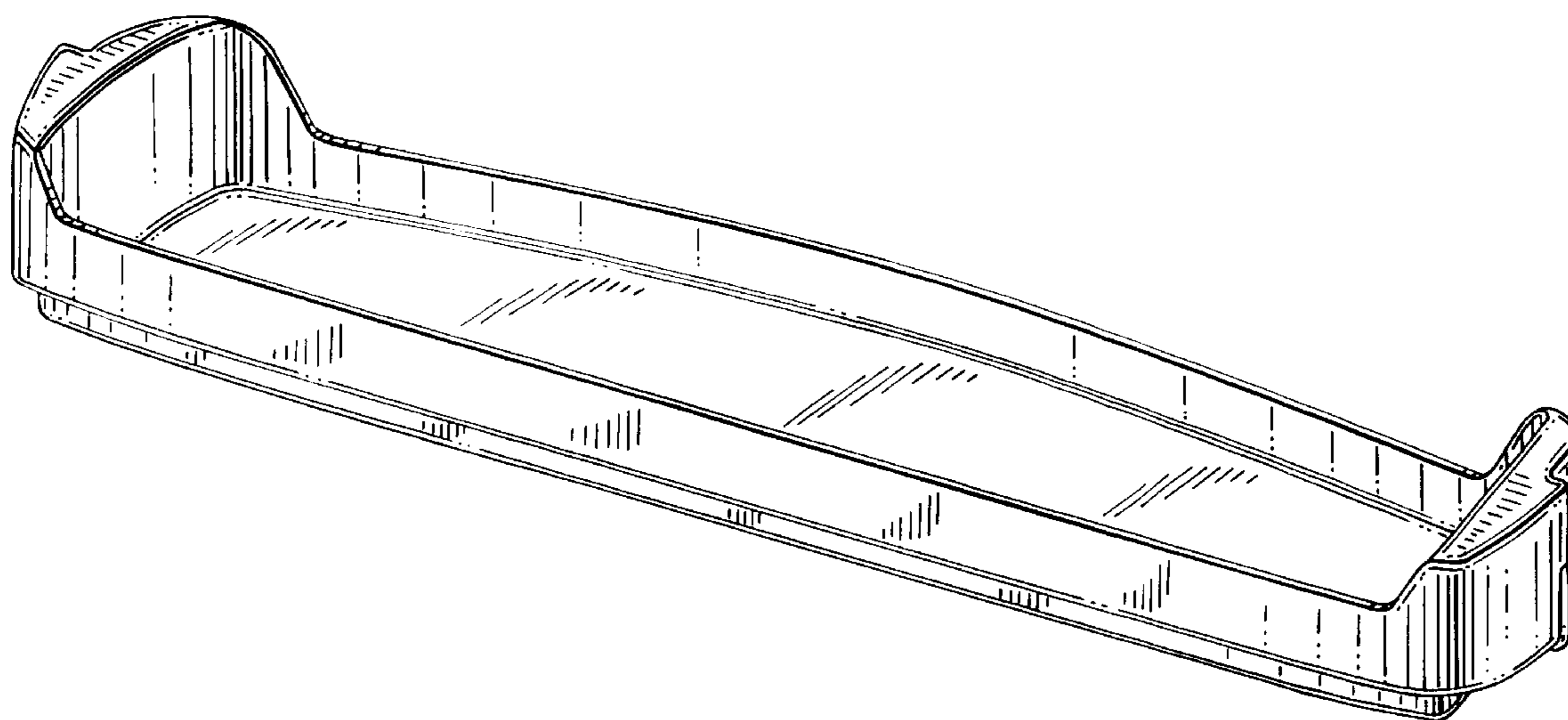
(57) **CLAIM**

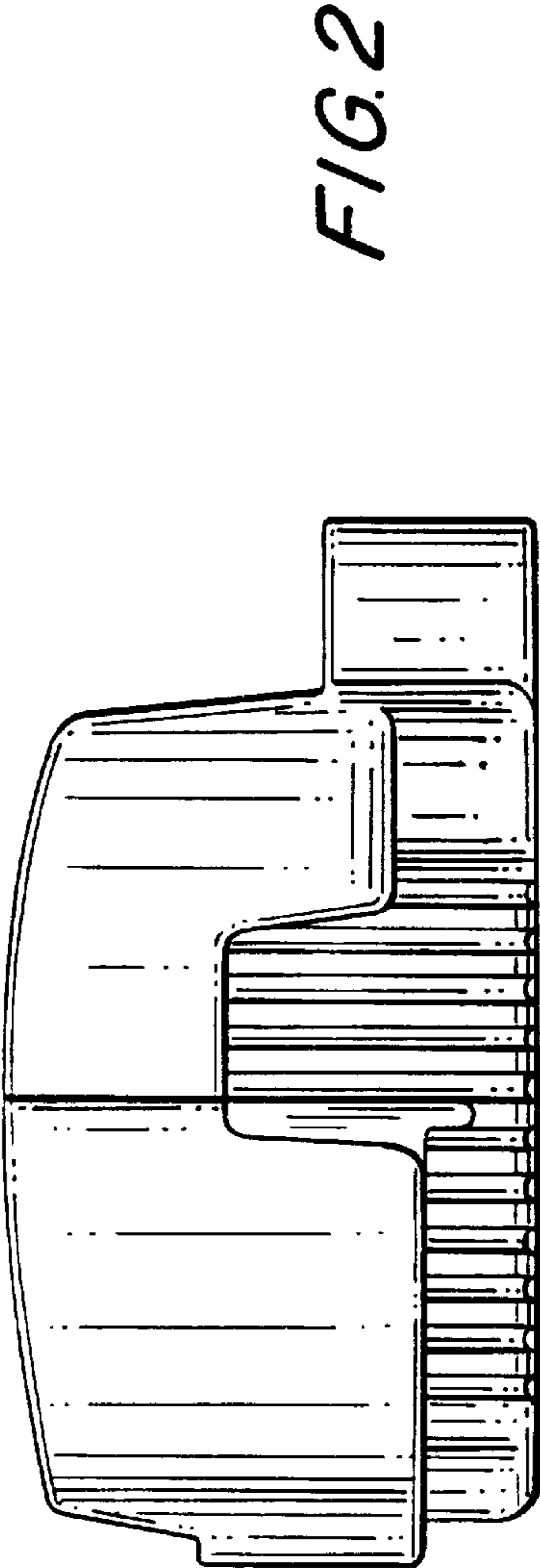
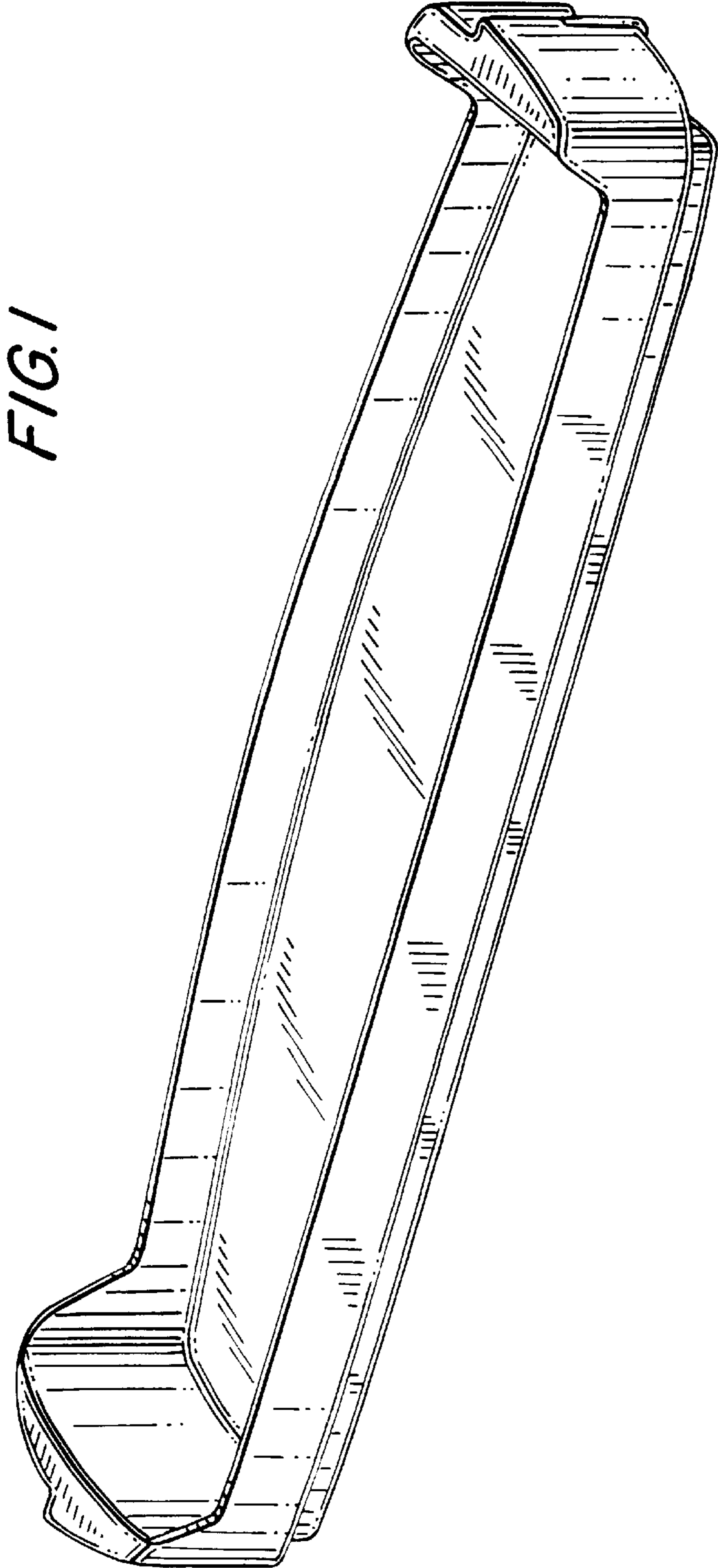
The ornamental design for shelf for refrigerator door, as shown and described.

**DESCRIPTION**

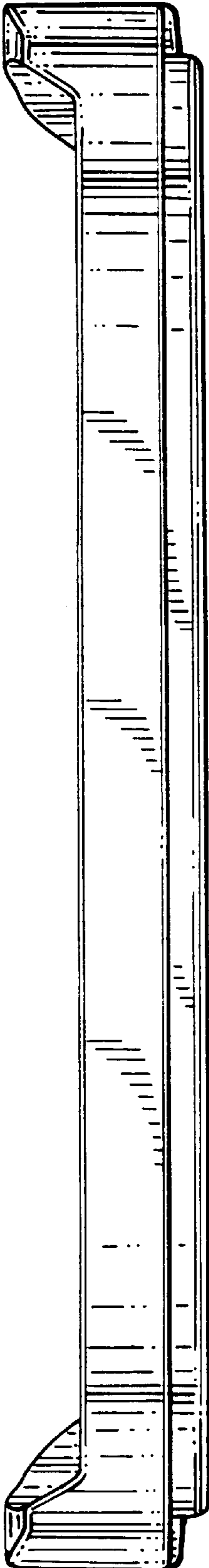
FIG. 1 is a front, top right side perspective view of shelf for refrigerator door of our invention;  
FIG. 2 is an enlarged elevation view of the right side of the shelf of FIG. 1, the left side elevation view being a mirror image thereof;  
FIG. 3 is a front elevation view thereof;  
FIG. 4 is a rear elevation view thereof;  
FIG. 5 is a top plan view thereof;  
FIG. 6 is a front, top right side elevation view of a second embodiment of the shelf of FIG. 1-5;  
FIG. 7 is an enlarged right side elevation view thereof, the left side a mirror image thereof;  
FIG. 8 is a front elevation thereof;  
FIG. 9 is a rear elevation thereof;  
FIG. 10 is a top plan view thereof;  
FIG. 11 is a front, top right side perspective view of a third embodiment of the shelf of FIGS. 1-5;  
FIG. 12 is an enlarged elevation view of the right side of the shelf of FIG. 11, the left side being a mirror image thereof;  
FIG. 13 is a front elevation view thereof;  
FIG. 14 is a rear elevation view thereof; and,  
FIG. 15 is a top plan view thereof.

**1 Claim, 9 Drawing Sheets**

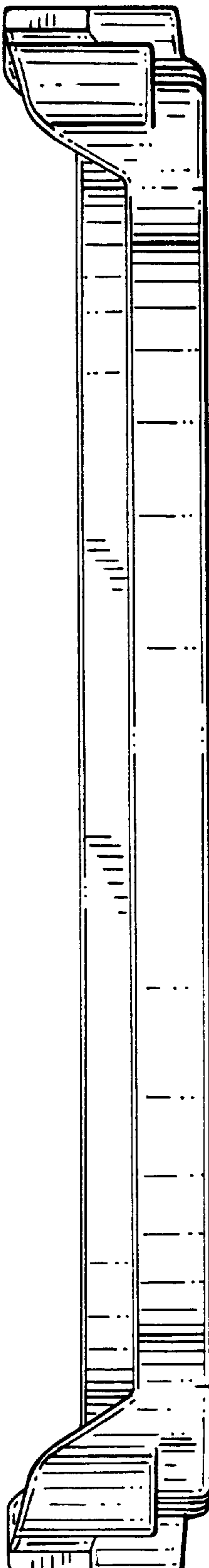




*FIG. 3*



*FIG. 4*



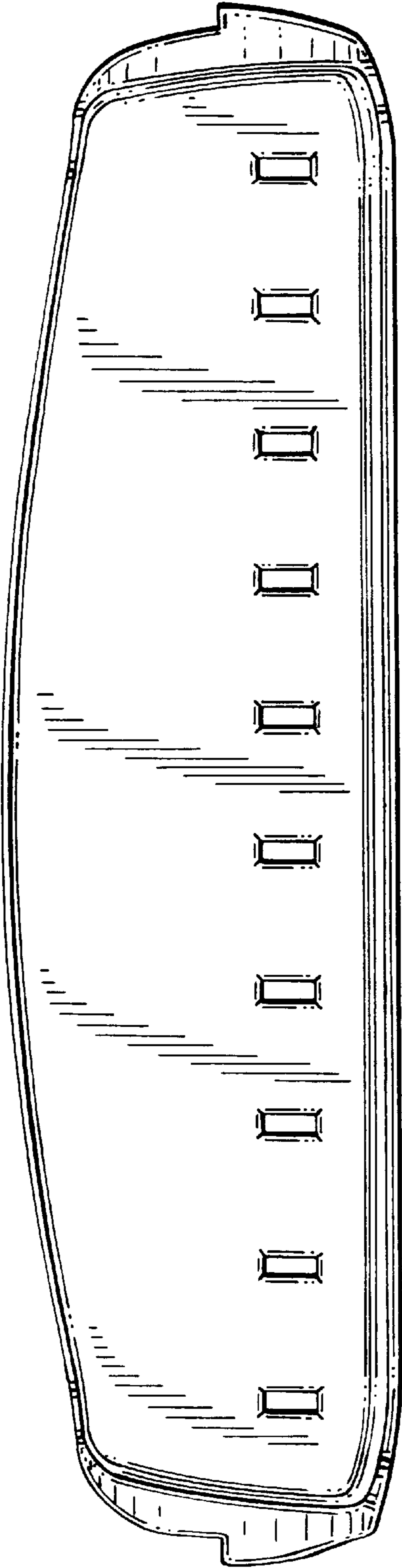


FIG. 5

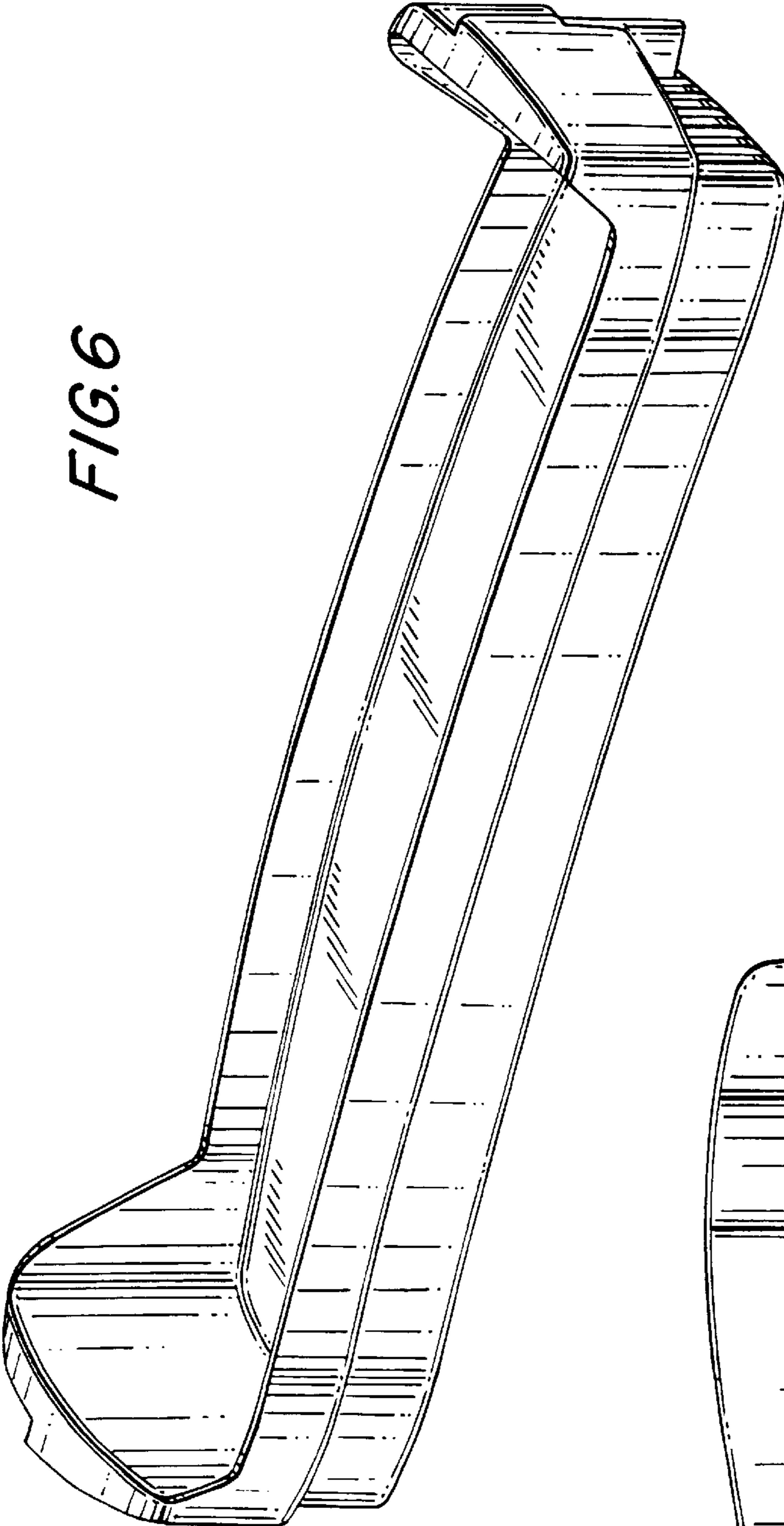


FIG. 6

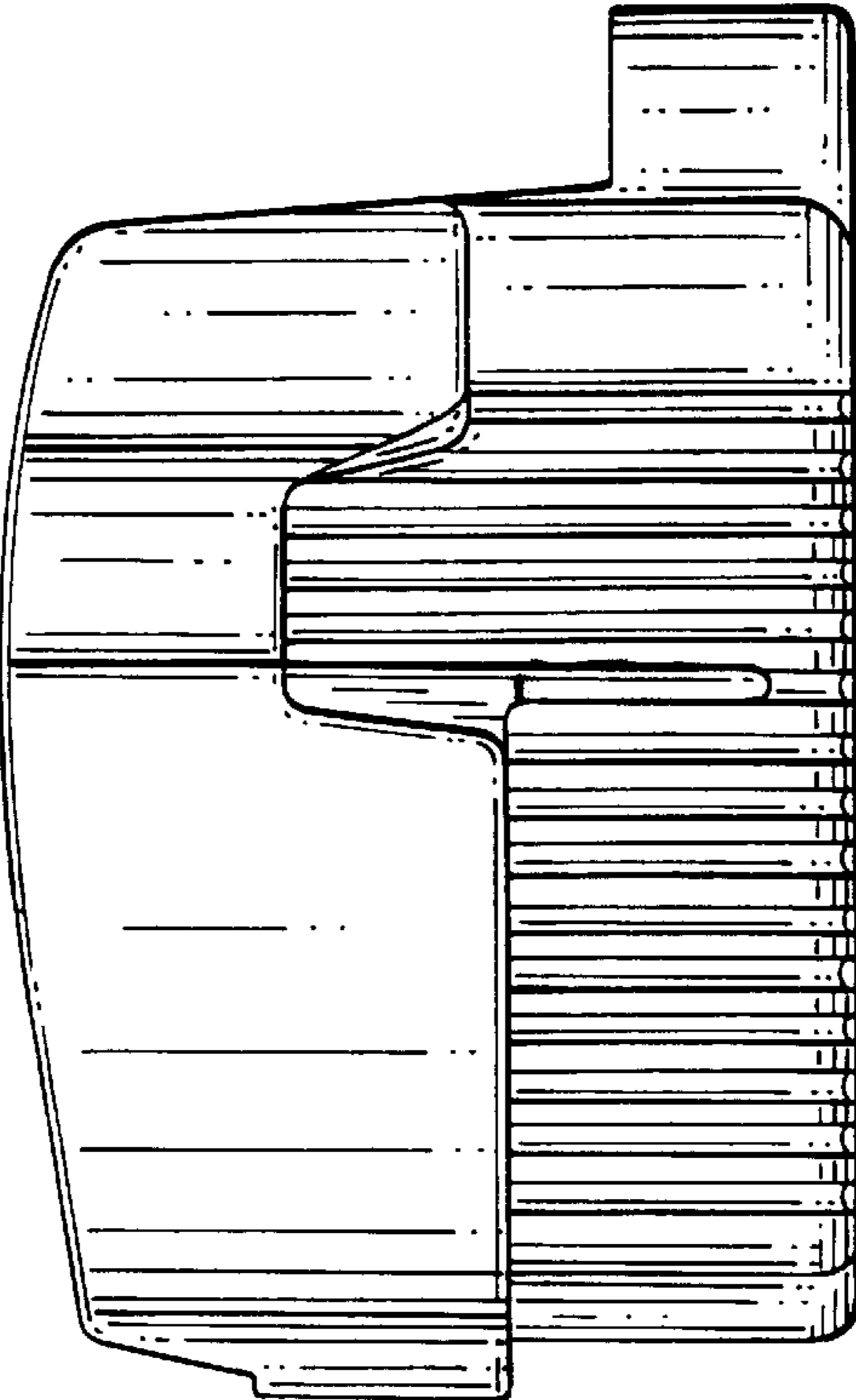
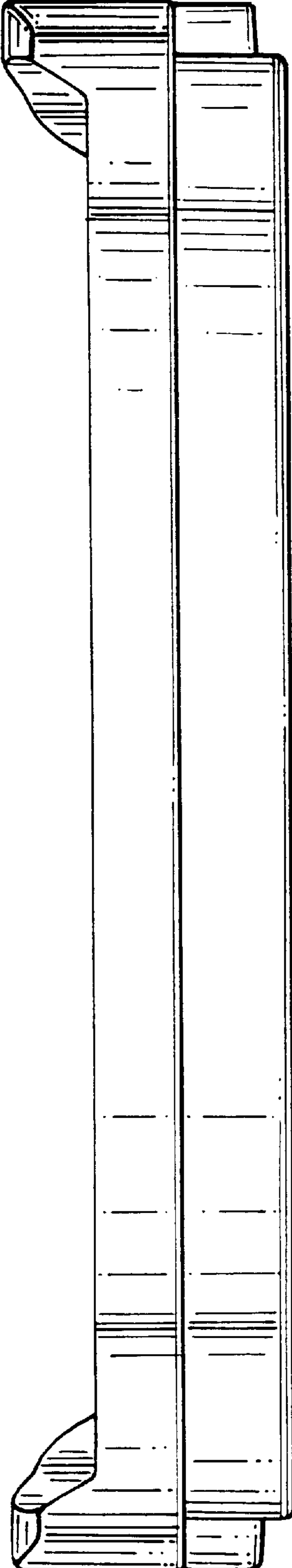
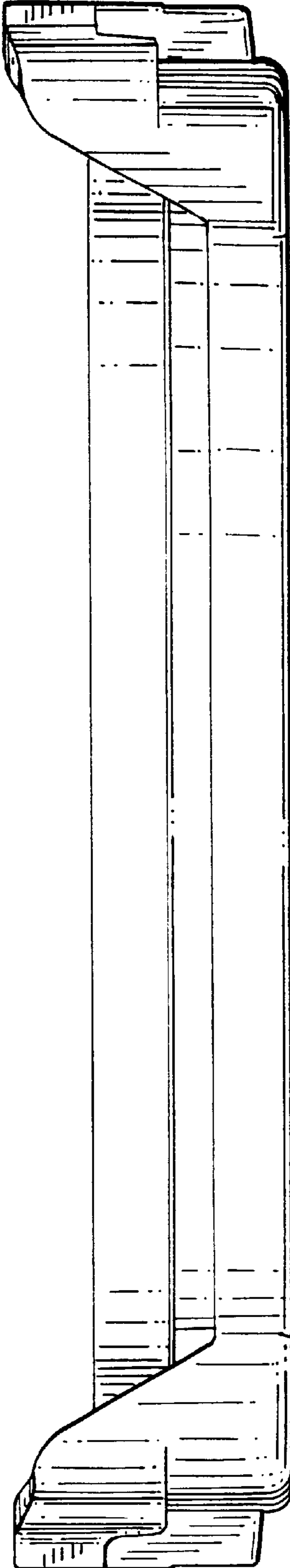


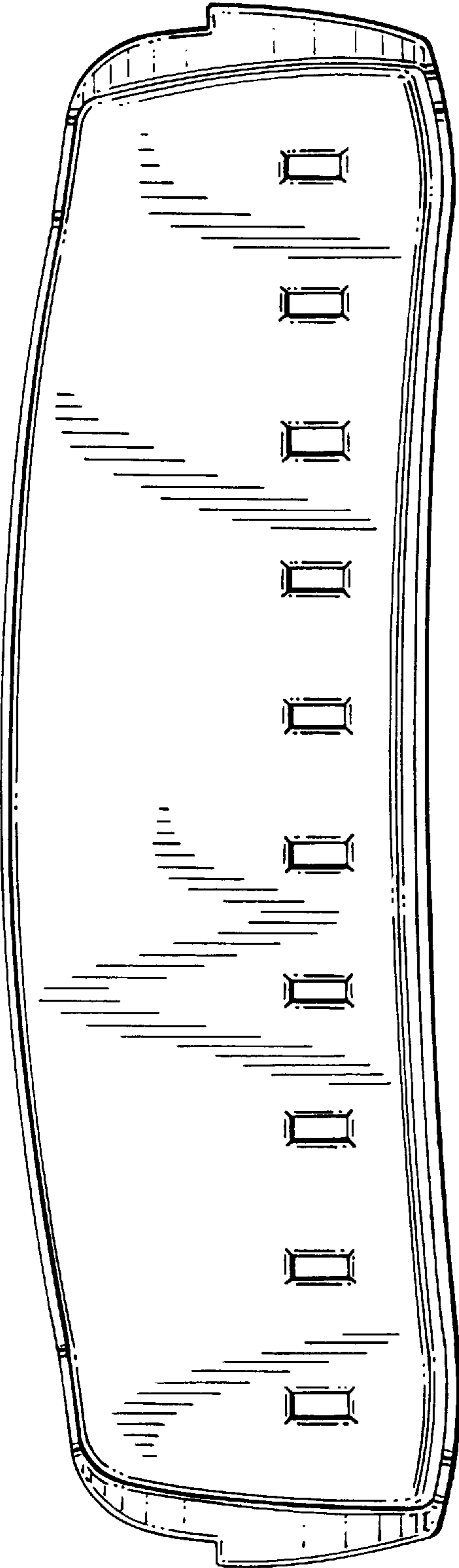
FIG. 7

*FIG. 8*

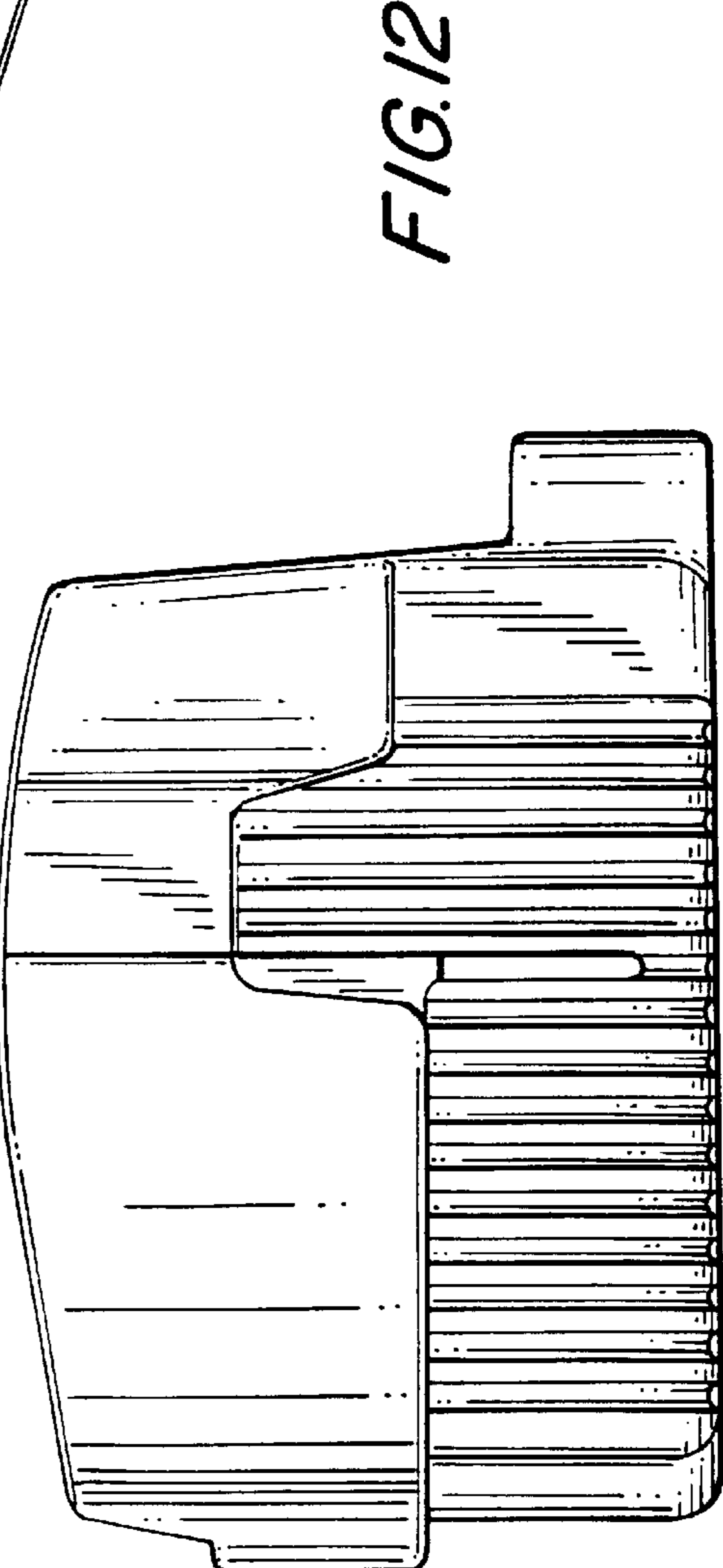
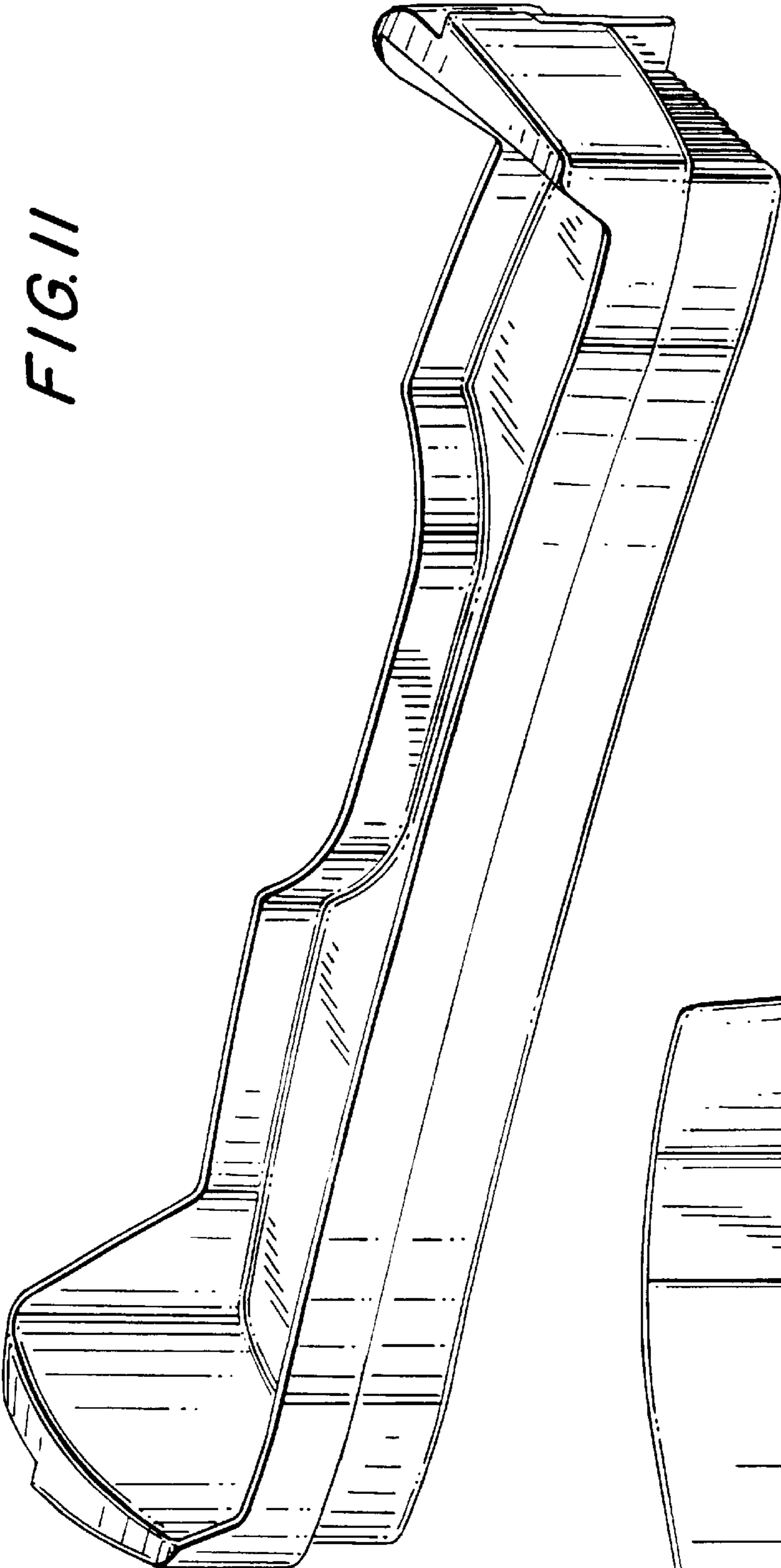


*FIG. 9*



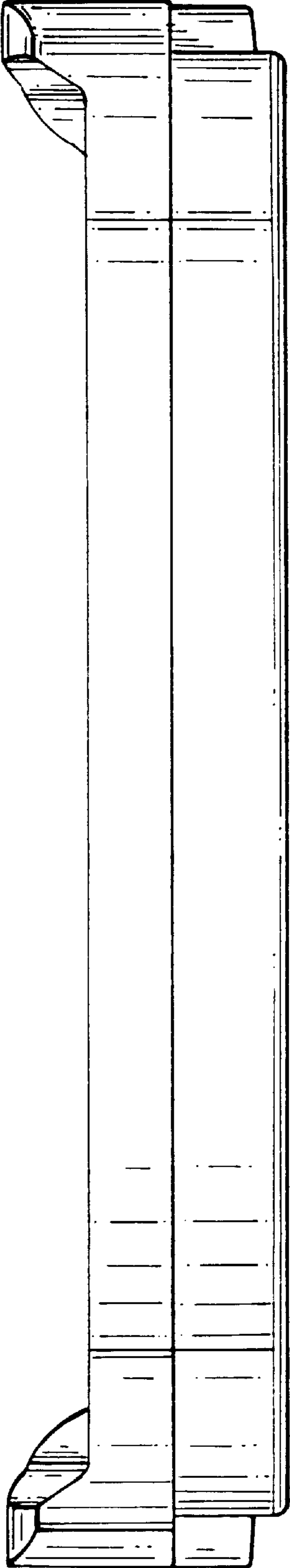


*FIG. 10*

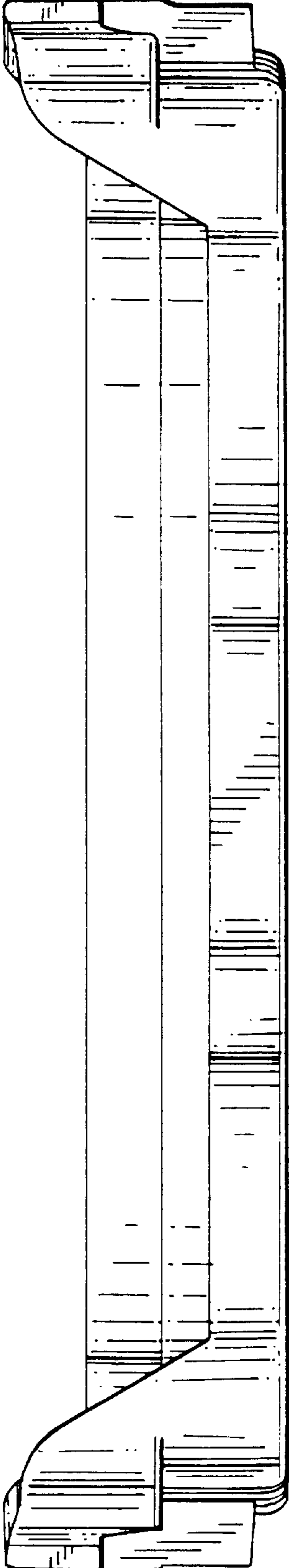




*FIG. 13*



*FIG. 14*



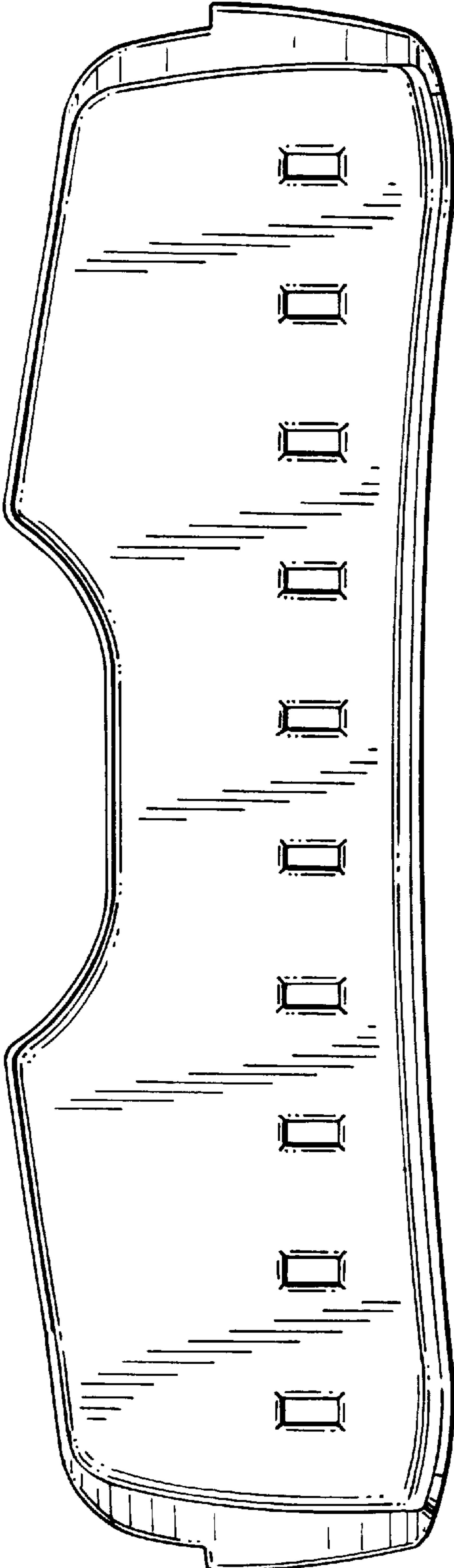


FIG. 15