

US00D506348S

(12) **United States Design Patent**
Josancy

(10) **Patent No.:** **US D506,348 S**
(45) **Date of Patent:** **** Jun. 21, 2005**

(54) **TOASTER**

D427,006 S * 6/2000 Chedal Anglay D7/330

(75) **Inventor:** **Luc Josancy**, Sainte-Colombe (FR)

* cited by examiner

(73) **Assignee:** **SEB**, Selongey (FR)

Primary Examiner—Caron D. Veynar
(74) *Attorney, Agent, or Firm*—Browdy and Neimark, P.L.L.C.

(**) **Term:** **14 Years**

(21) **Appl. No.:** **29/196,684**

(57) **CLAIM**

(22) **Filed:** **Jan. 5, 2004**

The ornamental design for a toaster, as shown.

(30) **Foreign Application Priority Data**

DESCRIPTION

Jul. 3, 2003 (FR) 03 3462

FIG. 1 is a front elevational view of a toaster in accordance with the present design;

(51) **LOC (8) Cl.** **07-02**

FIG. 2 is a rear elevational view thereof;

(52) **U.S. Cl.** **D7/330**

FIG. 3 is a left side elevational view thereof;

(58) **Field of Search** D7/323, 328-330,
D7/390; 99/372, 385-402

FIG. 4 is a right side elevational view thereof;

FIG. 5 is a top plan view thereof;

FIG. 6 is a bottom plan view thereof; and,

FIG. 7 is a perspective view thereof.

(56) **References Cited**

U.S. PATENT DOCUMENTS

D375,017 S * 10/1996 Barrault D7/330

1 Claim, 7 Drawing Sheets

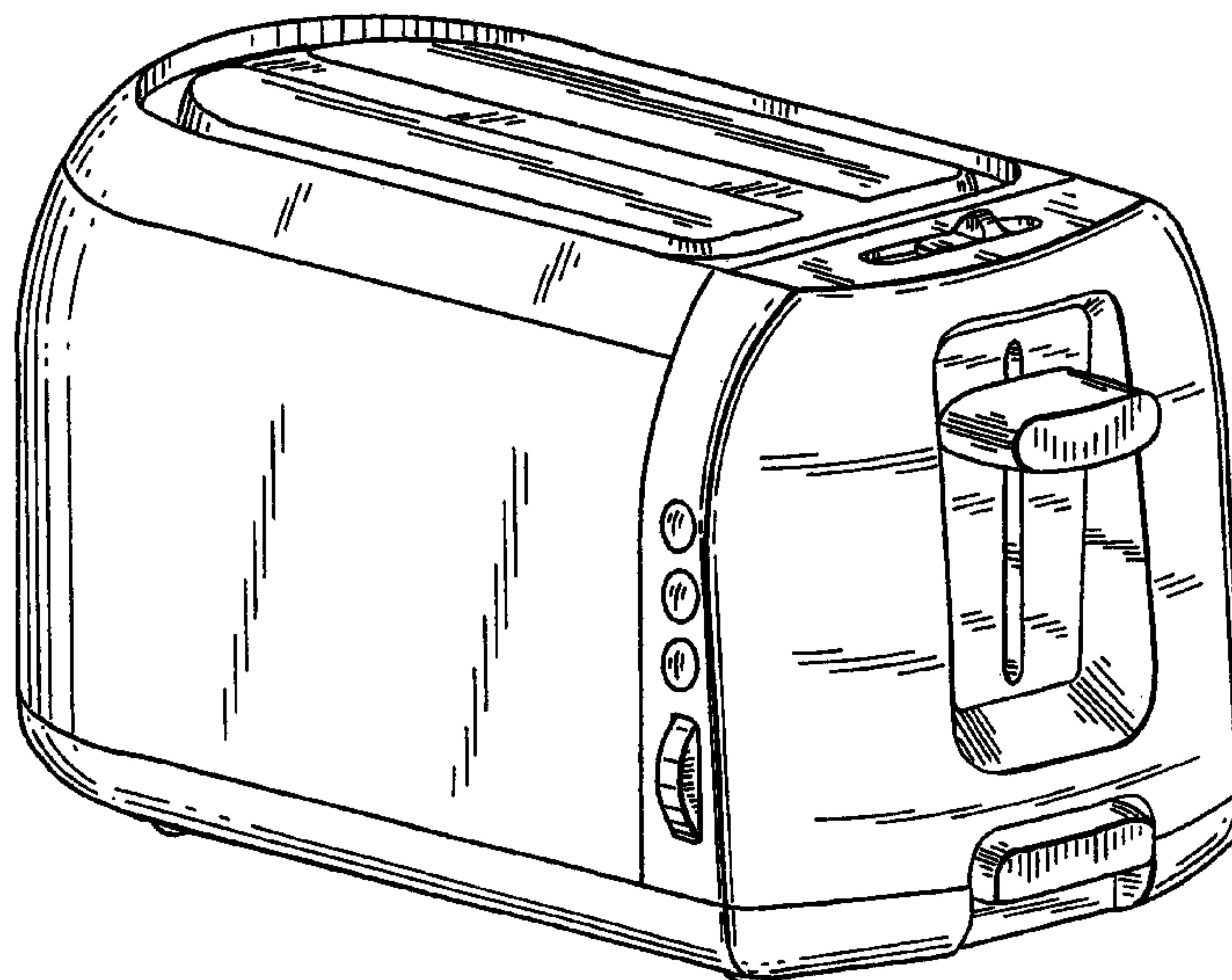
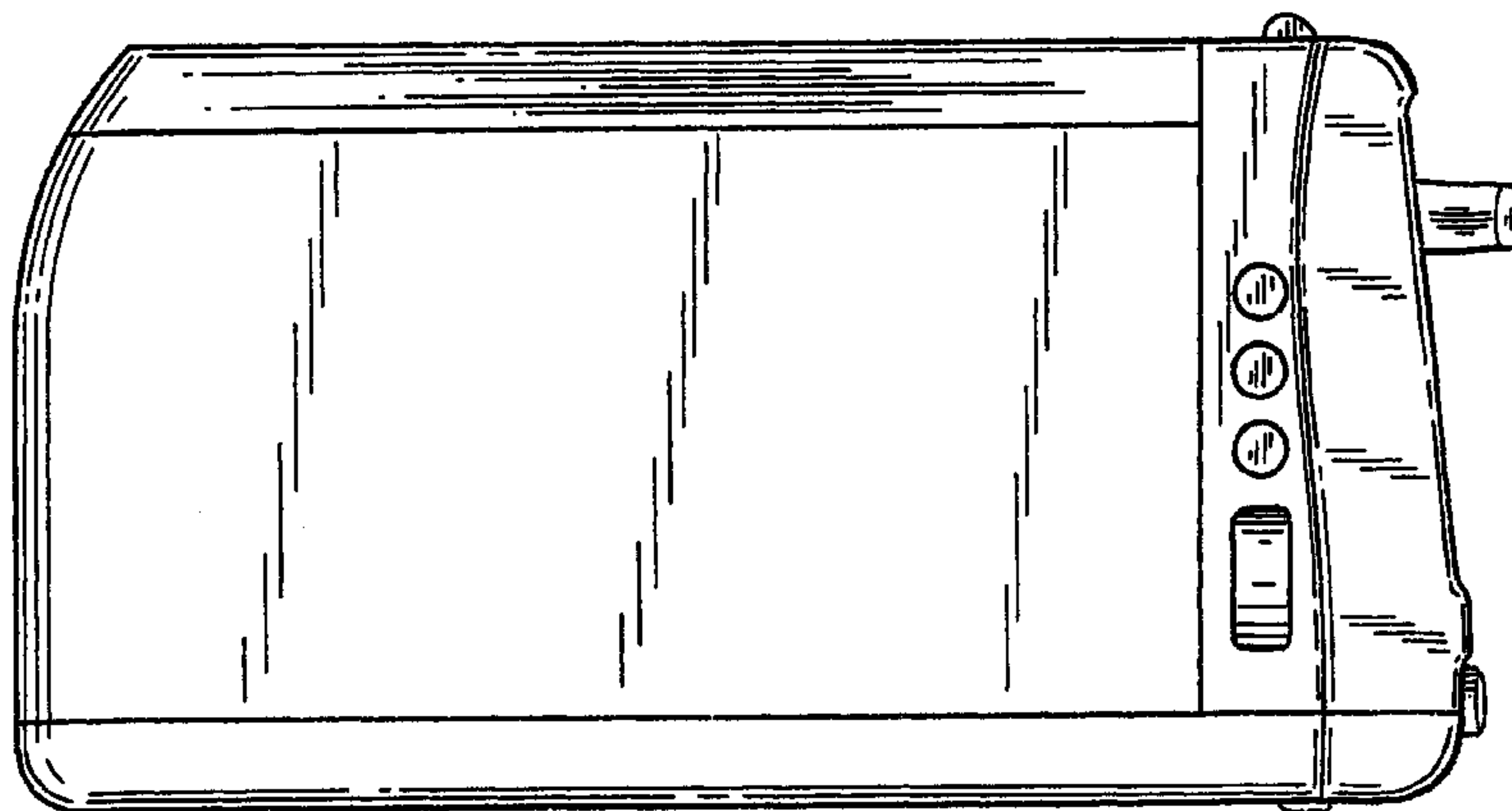

FIG. 1

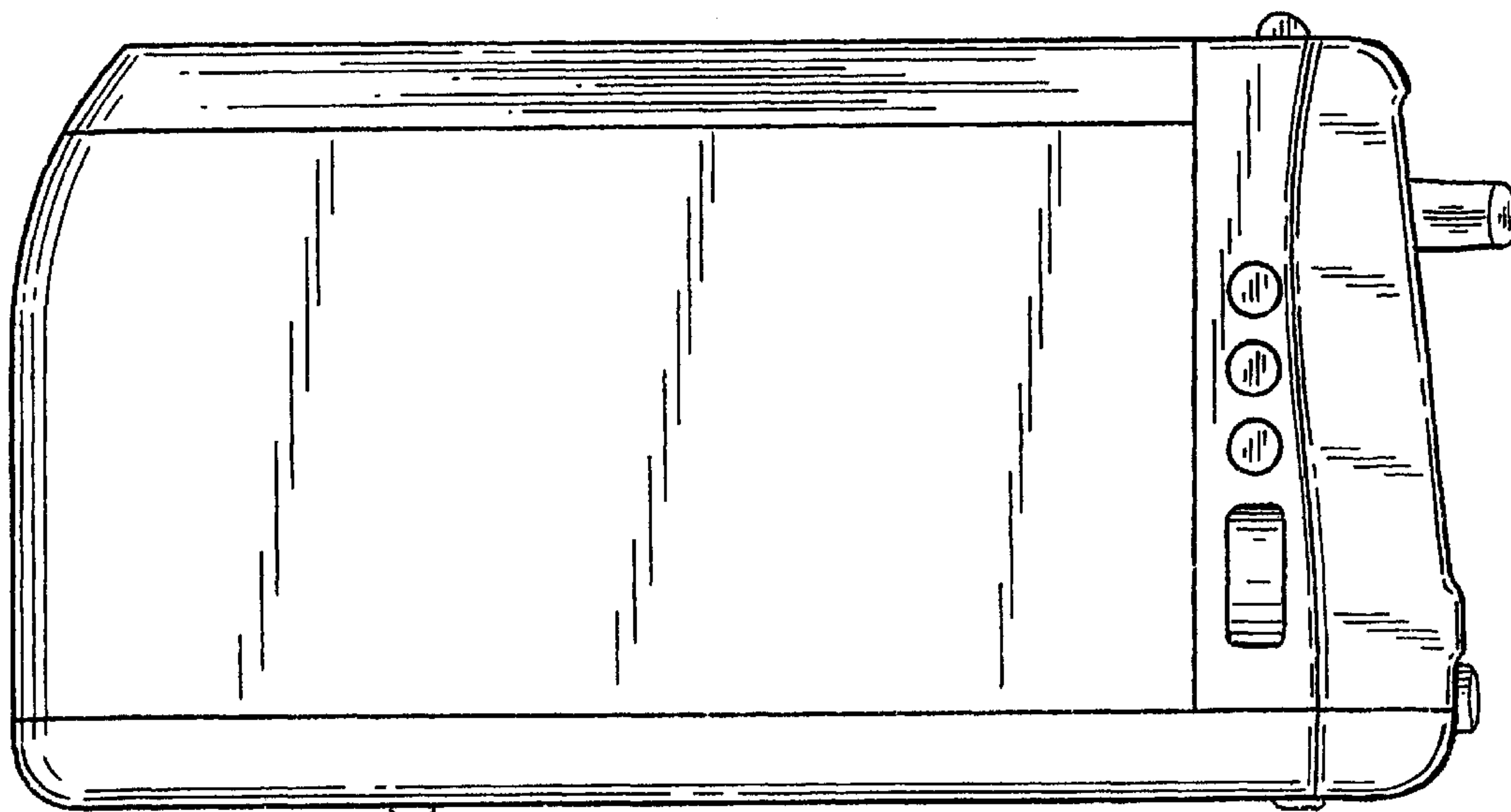

FIG. 2

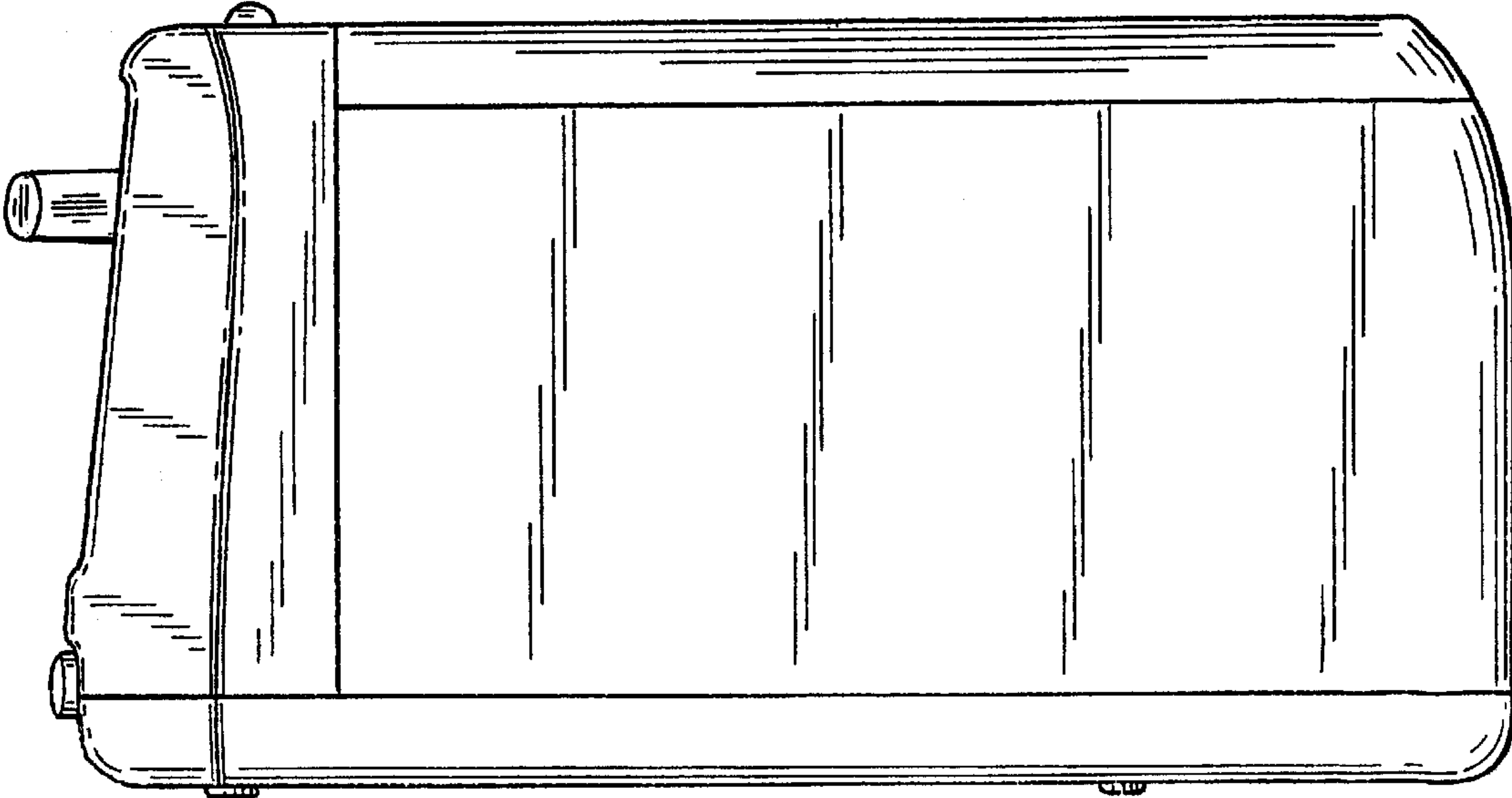

FIG. 3

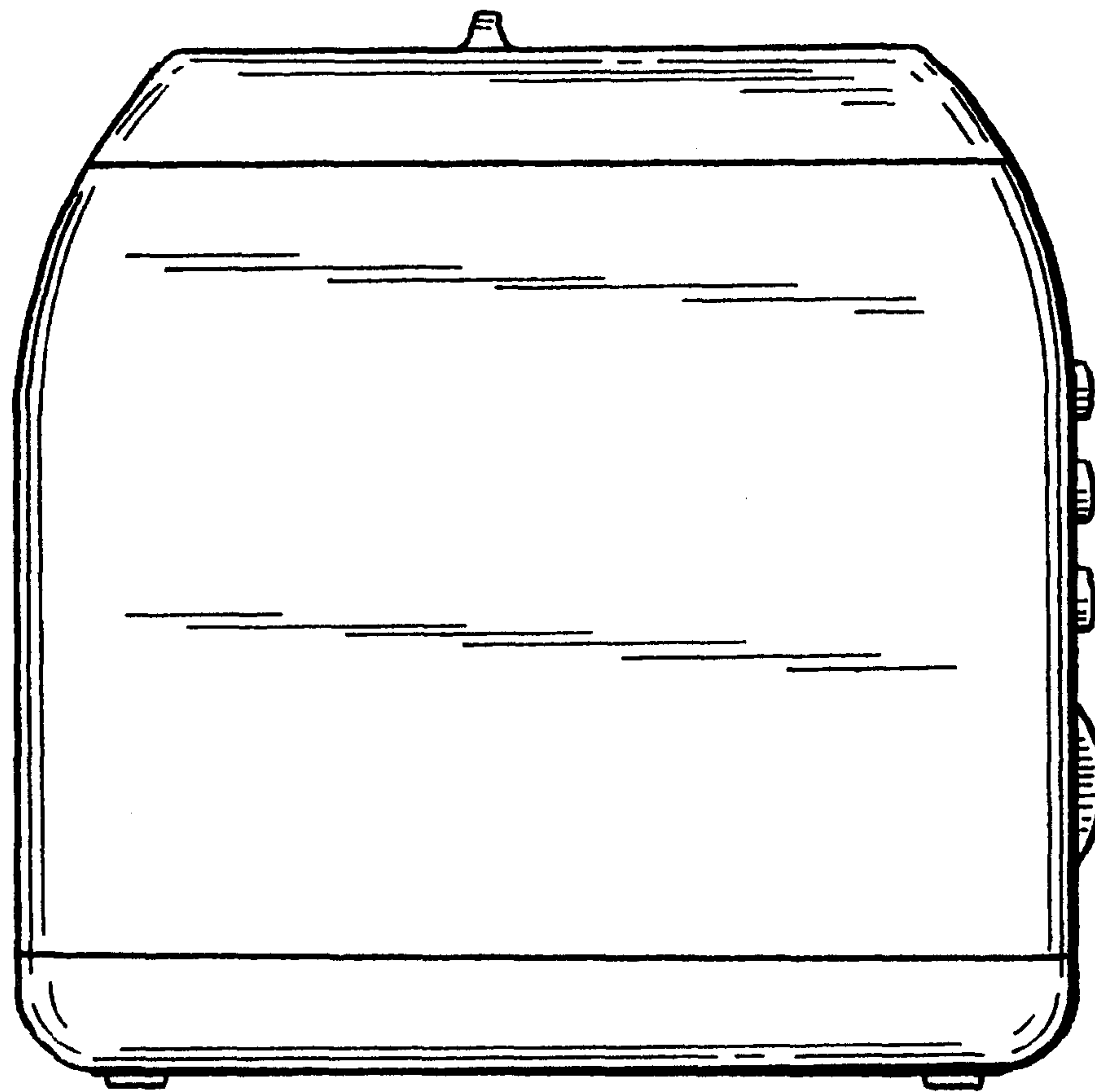

FIG. 4

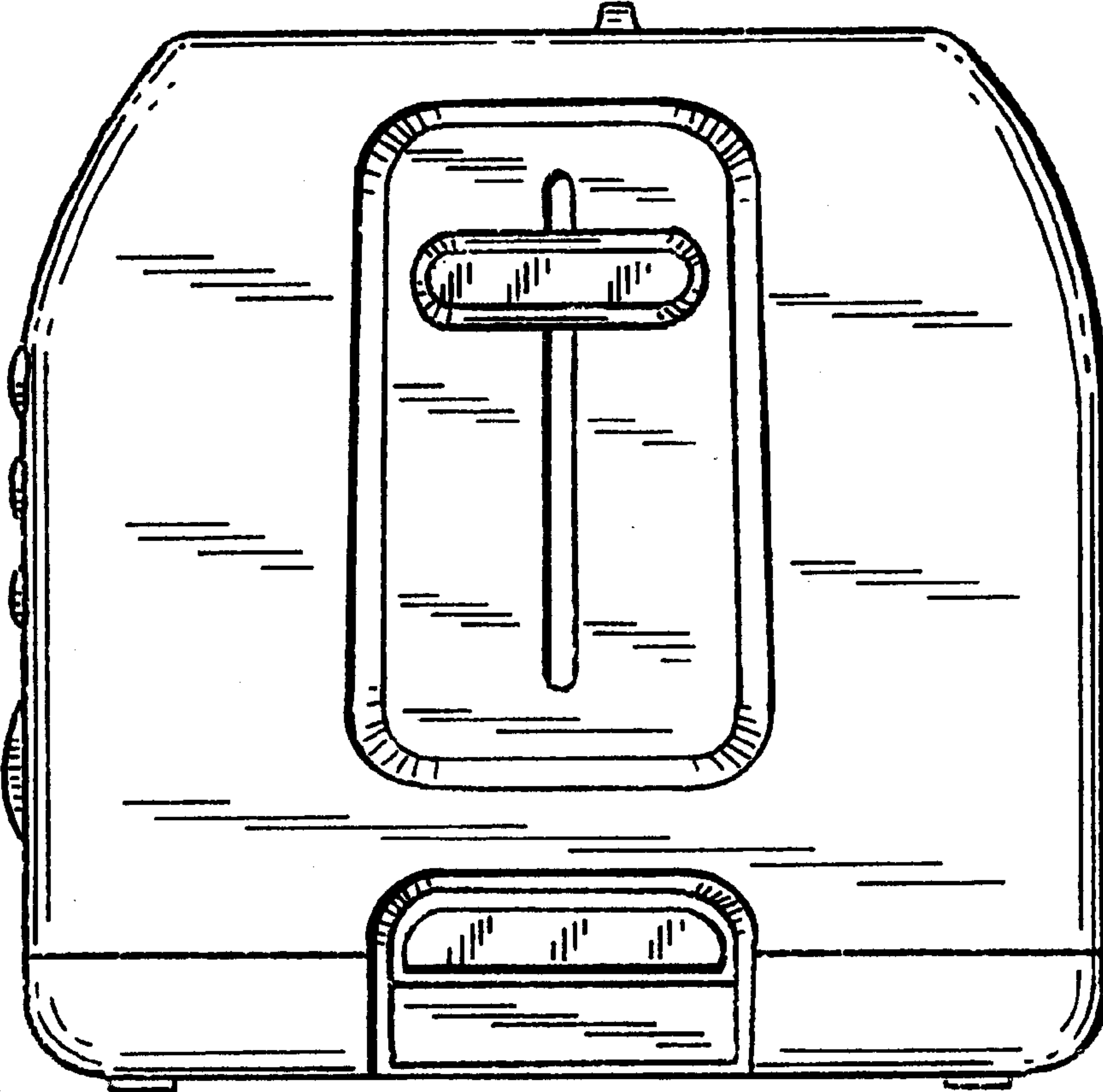

FIG. 5

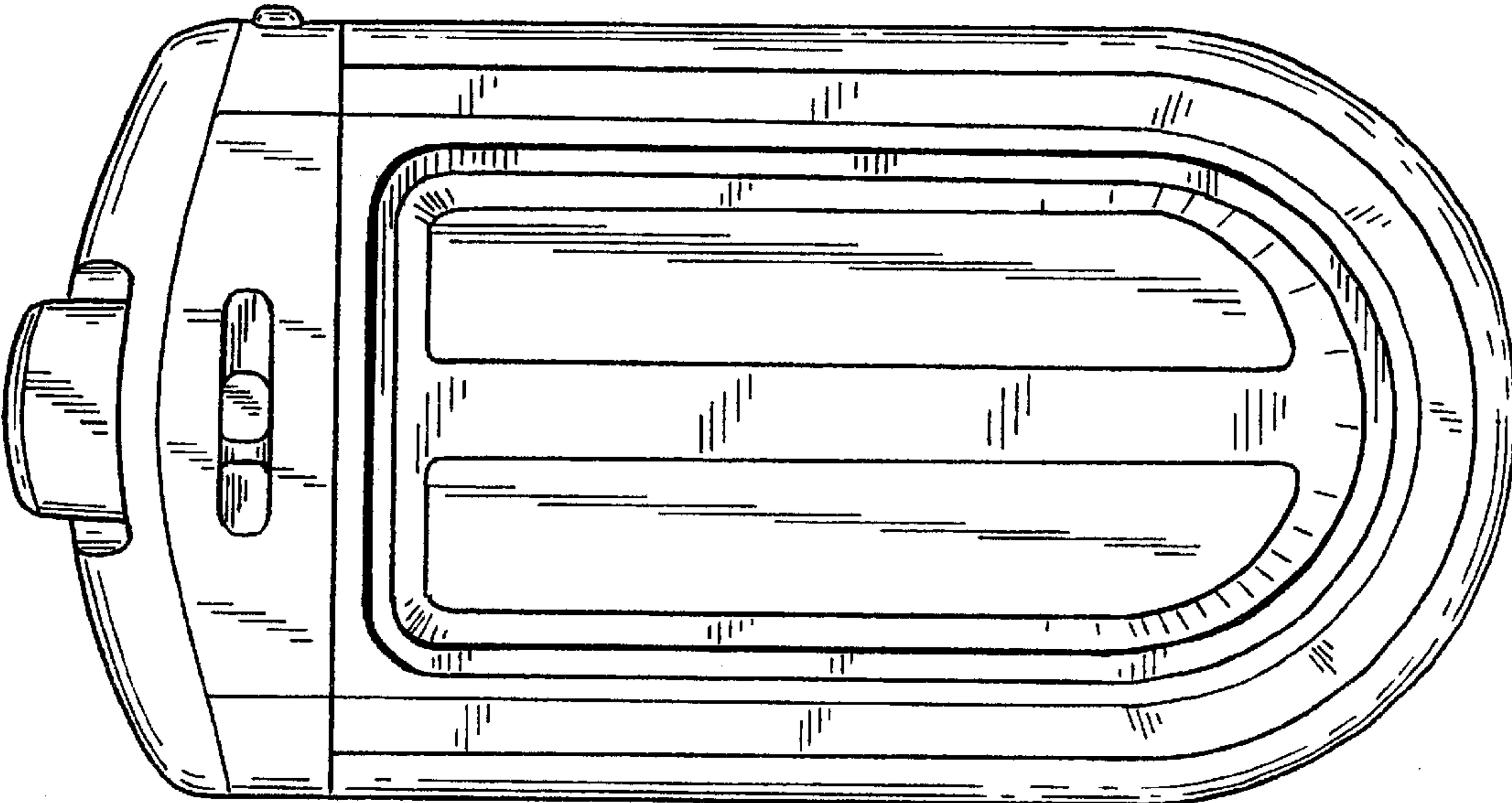

FIG. 6

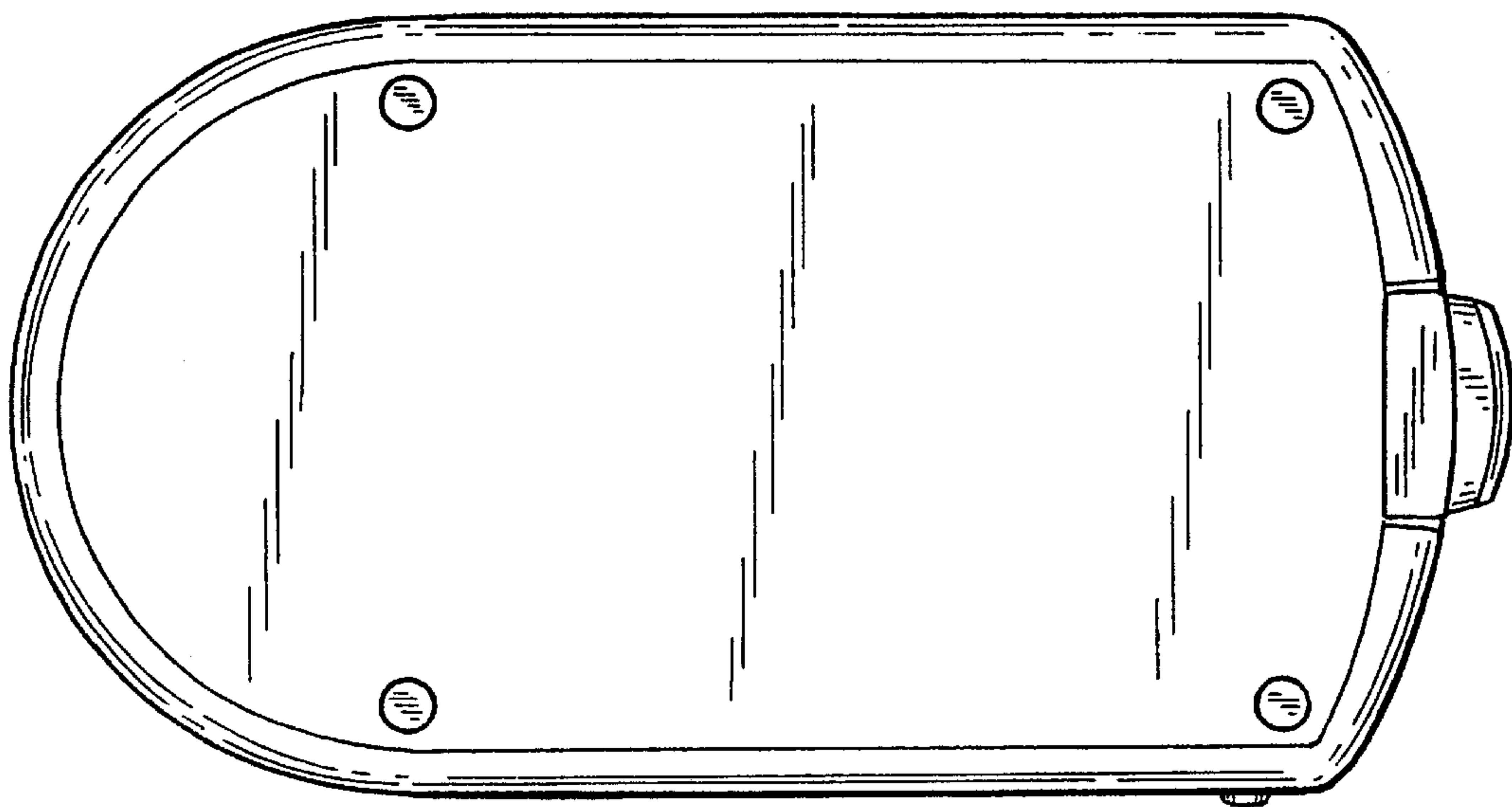

FIG. 7

