

US00D506065S

(12) **United States Design Patent**
Sugino et al.

(10) **Patent No.: US D506,065 S**
(45) **Date of Patent: ** Jun. 14, 2005**

(54) **RECHARGEABLE BATTERY STORAGE CASE**

(75) Inventors: **Kenichi Sugino, Kyoto (JP); Tsushima Takada, Kyoto (JP); Masato Ibuki, Kyoto (JP)**

(73) Assignee: **Nintendo Co., Ltd., Kyoto (JP)**

(**) Term: **14 Years**

(21) Appl. No.: **29/211,051**

(22) Filed: **Jun. 22, 2001**

(30) **Foreign Application Priority Data**

Dec. 25, 2000 (JP) 2000-036909

(51) **LOC (8) Cl. 03-01**

(52) **U.S. Cl. D3/294; D13/103**

(58) **Field of Search** D3/273, 276, 281, D3/283, 294, 295; D9/420, 423, 424; 206/703, 278; 220/810, 825, 833, 834; D13/103

(56) **References Cited**

U.S. PATENT DOCUMENTS

- D259,596 S * 6/1981 Gray D3/205
- D274,408 S * 6/1984 Fernandez D9/423
- D280,678 S * 9/1985 Loscalzo et al. D3/294
- D316,932 S * 5/1991 Escher, Jr. D3/265
- D361,978 S 9/1995 Shirai et al.
- D367,211 S * 2/1996 Cautereels D7/629
- D400,011 S * 10/1998 Palmer et al. D3/294
- 5,860,550 A * 1/1999 Miller et al. 220/4.23
- D404,917 S * 2/1999 Miller et al. D3/294
- D411,446 S * 6/1999 Cautereels D9/757

- D418,297 S * 1/2000 Budert D3/295
- D449,165 S * 10/2001 van der Hulst D3/294
- D456,008 S 4/2002 Kawanobe et al. D13/103
- D457,133 S 5/2002 Yoneyama D13/103
- D468,264 S 1/2003 Sugino D21/332
- D468,743 S 1/2003 Kawanobe et al. D13/110
- D478,127 S 8/2003 Nishikawa D13/103
- D478,866 S 8/2003 Nakai D13/103

* cited by examiner

Primary Examiner—Philip S. Hyder

(74) *Attorney, Agent, or Firm*—Nixon & Vanderhye P.C.

(57) **CLAIM**

The ornamental design for a “rechargeable battery storage case,” as shown and described.

DESCRIPTION

FIG. 1 is a front elevational view of a rechargeable battery storage case;
 FIG. 2 is a top plan view thereof;
 FIG. 3 is a rear elevational view thereof;
 FIG. 4 is a bottom plan view thereof;
 FIG. 5 is a right side view thereof;
 FIG. 6 is a front elevational view with a lid opened thereof;
 FIG. 7 is a top plan view with a lid opened thereof;
 FIG. 8 is a rear elevational view with a lid opened thereof;
 FIG. 9 is a bottom plan view with a lid opened thereof;
 FIG. 10 is a right side view with a lid opened thereof;
 FIG. 11 is a top, front and left side perspective view thereof;
 FIG. 12 is a bottom, rear and left side perspective view thereof; and,
 FIG. 13 is a top, front and left side perspective view with a lid opened thereof.

1 Claim, 8 Drawing Sheets

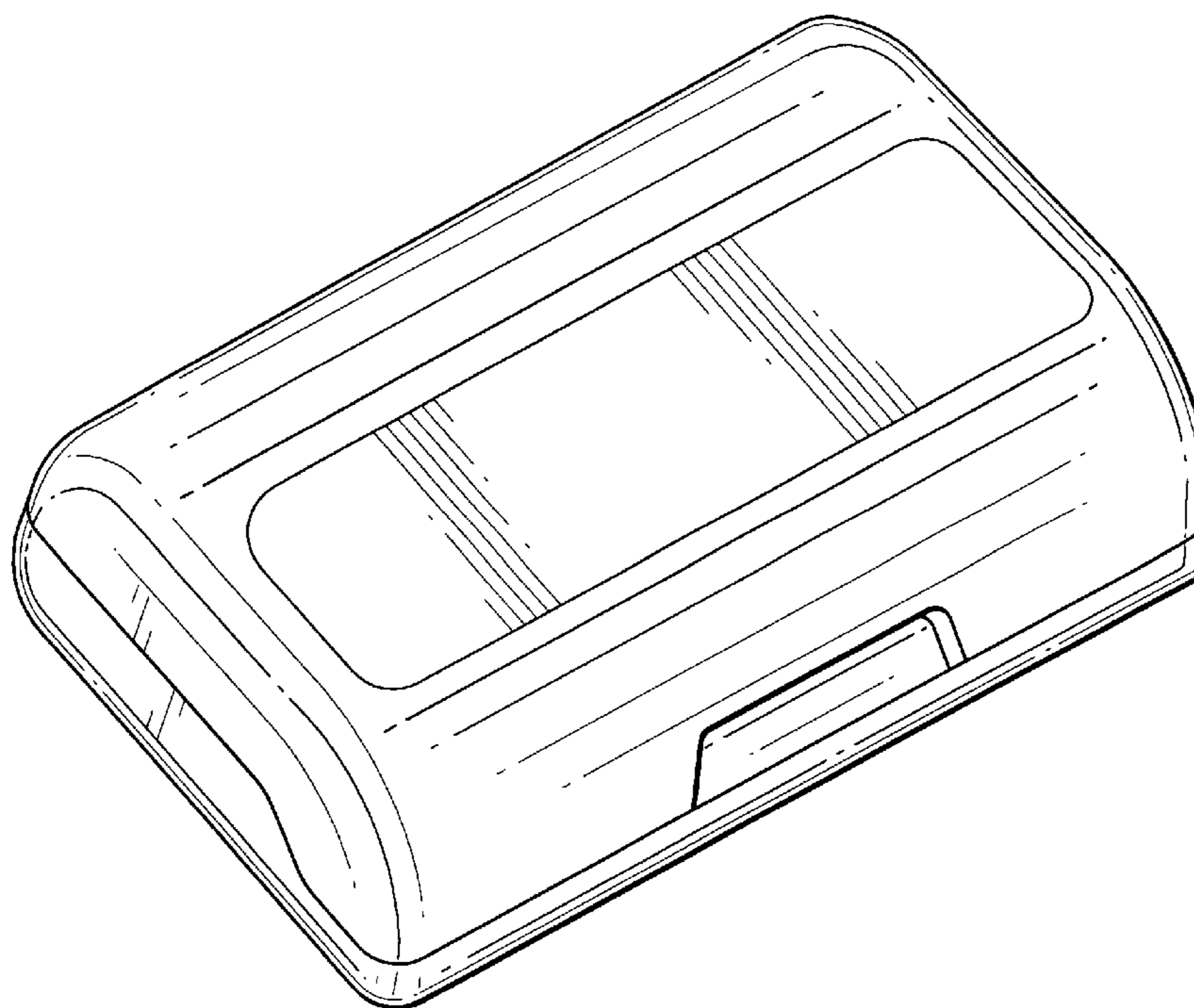

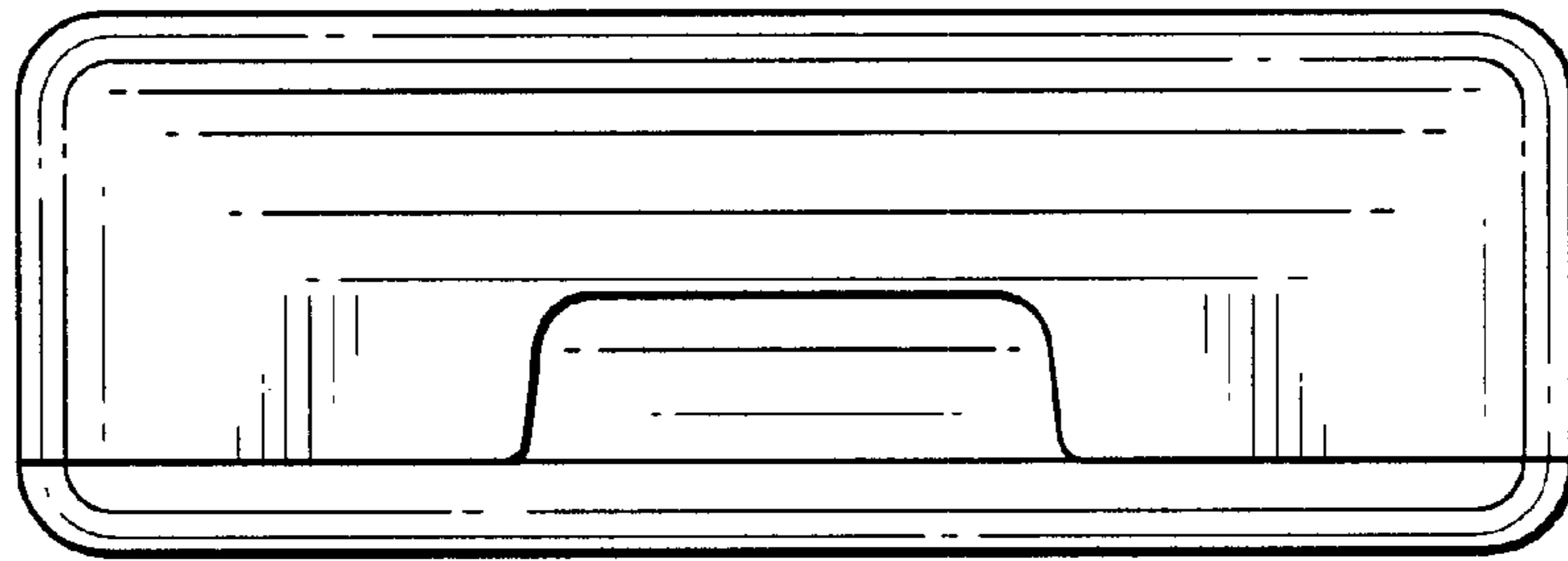

Fig. 1

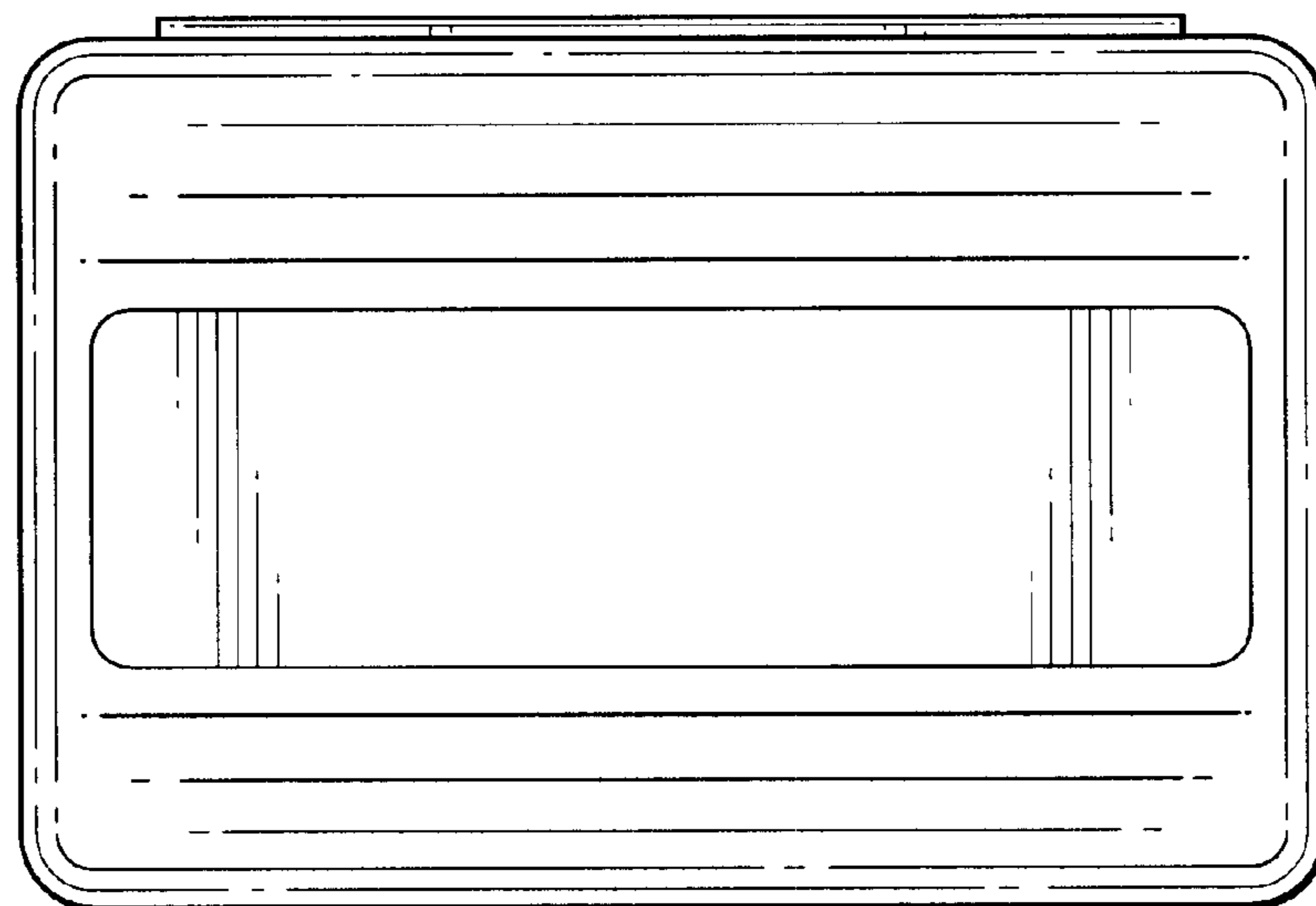

Fig. 2

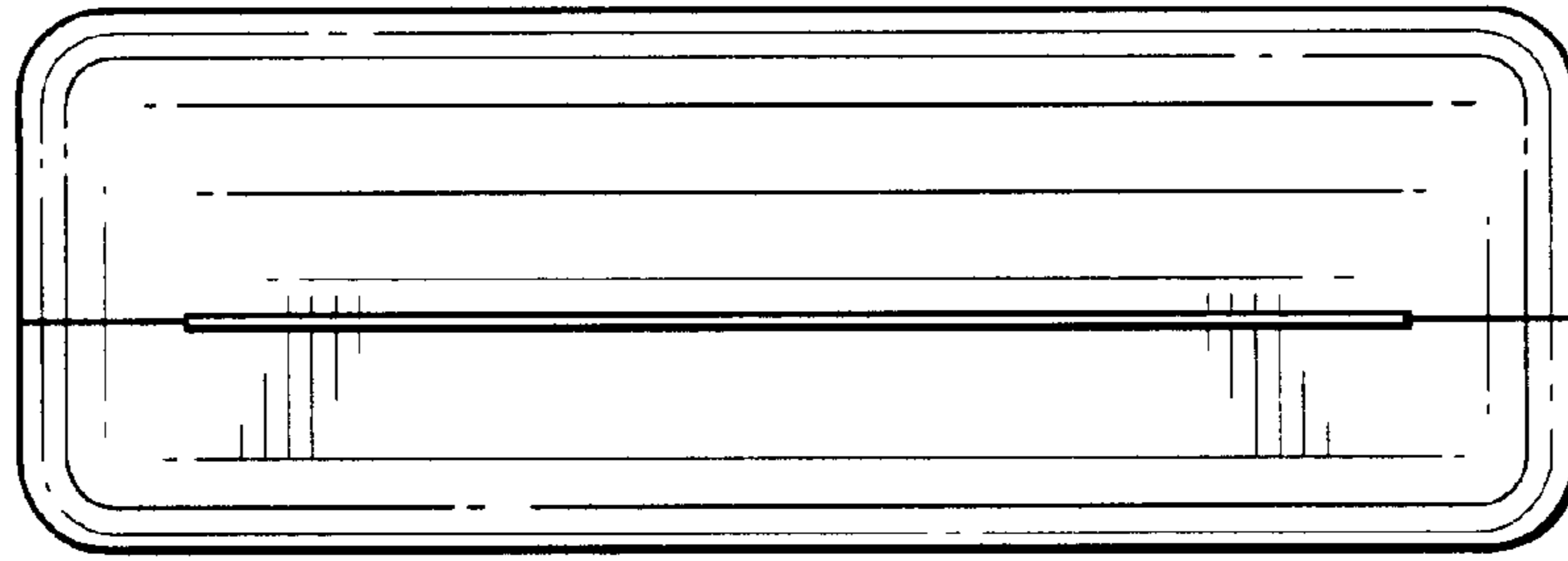

Fig. 3

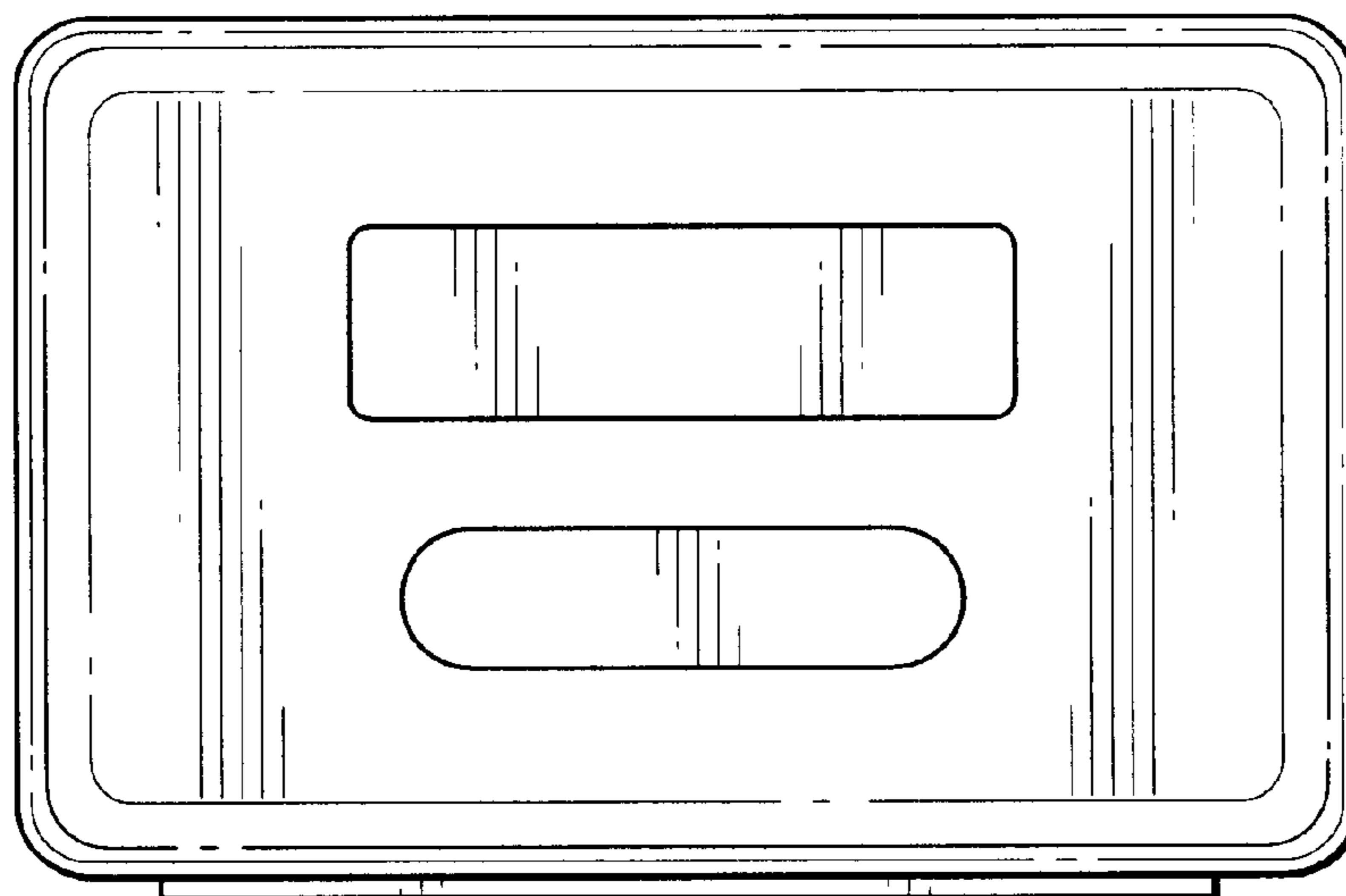

Fig. 4

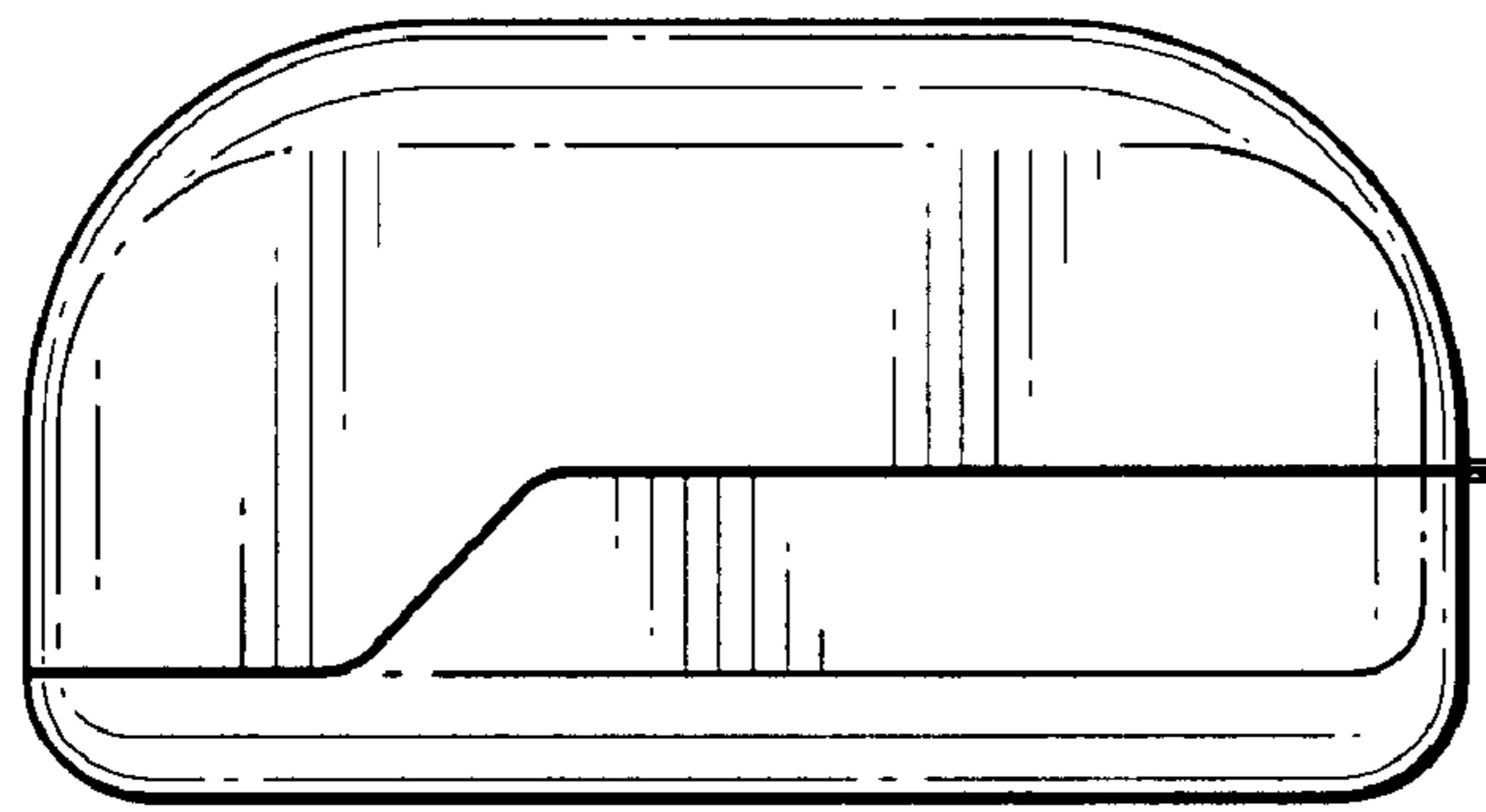

Fig. 5

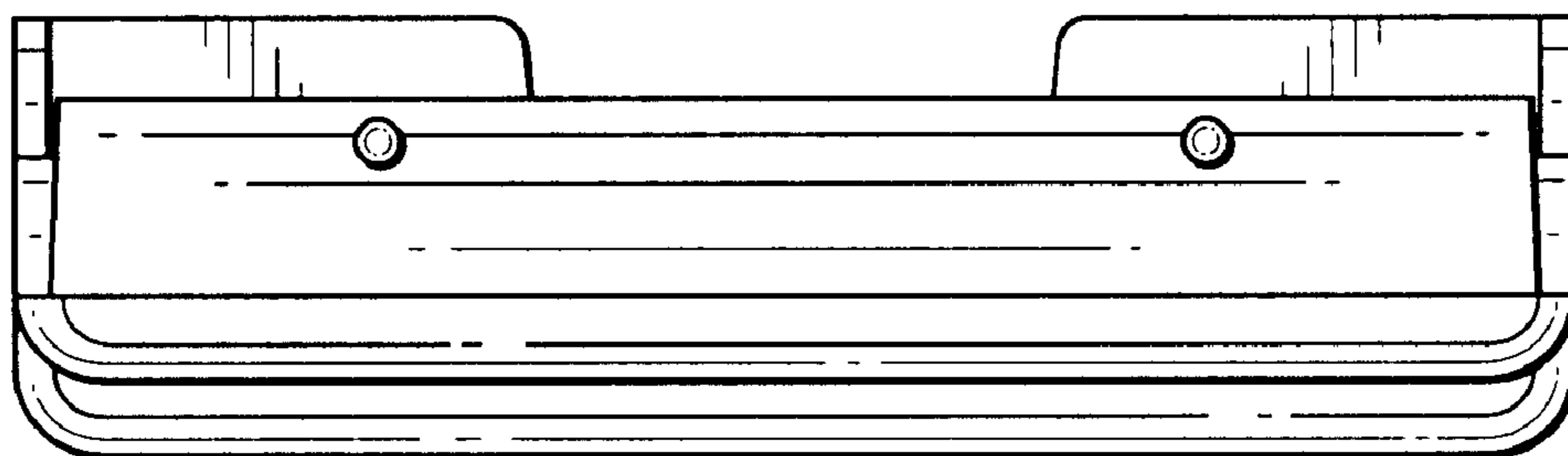

Fig. 6

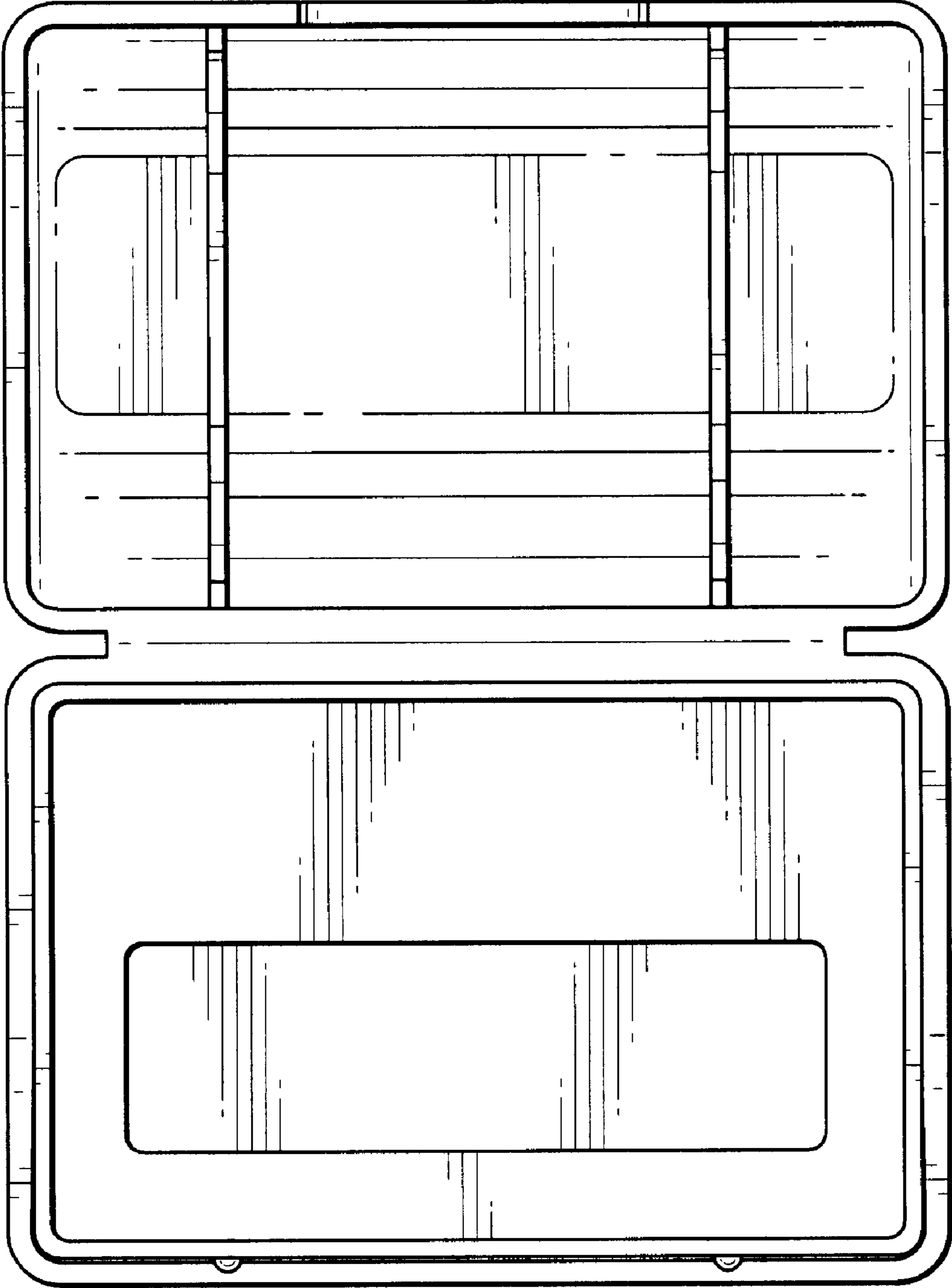

Fig. 7

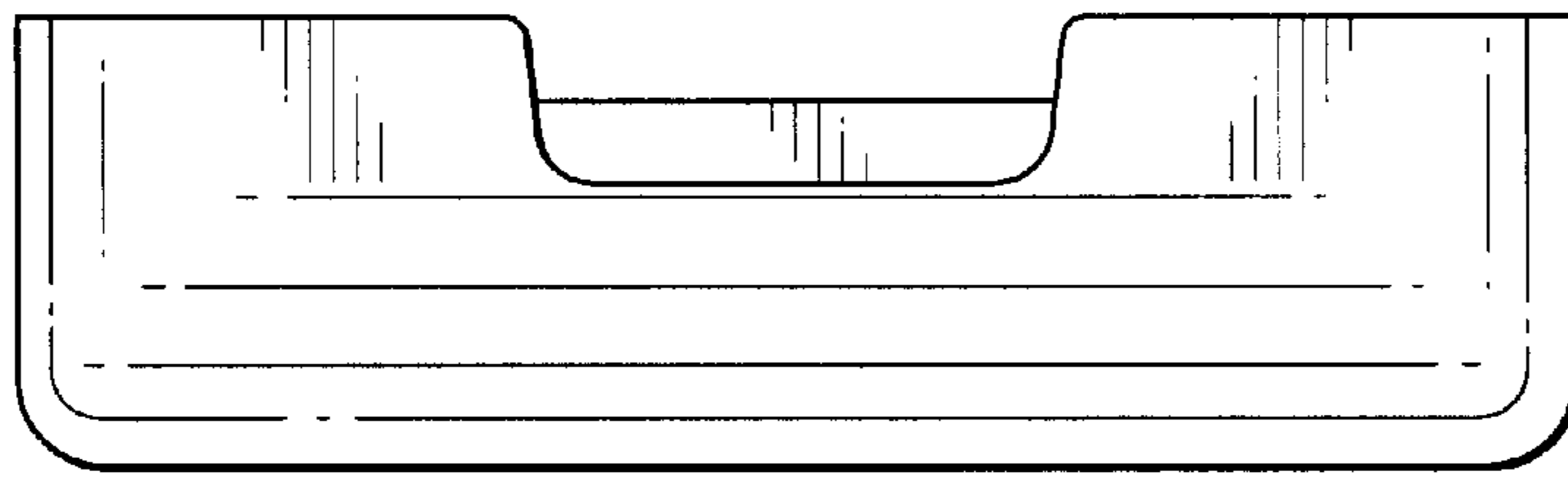

Fig. 8

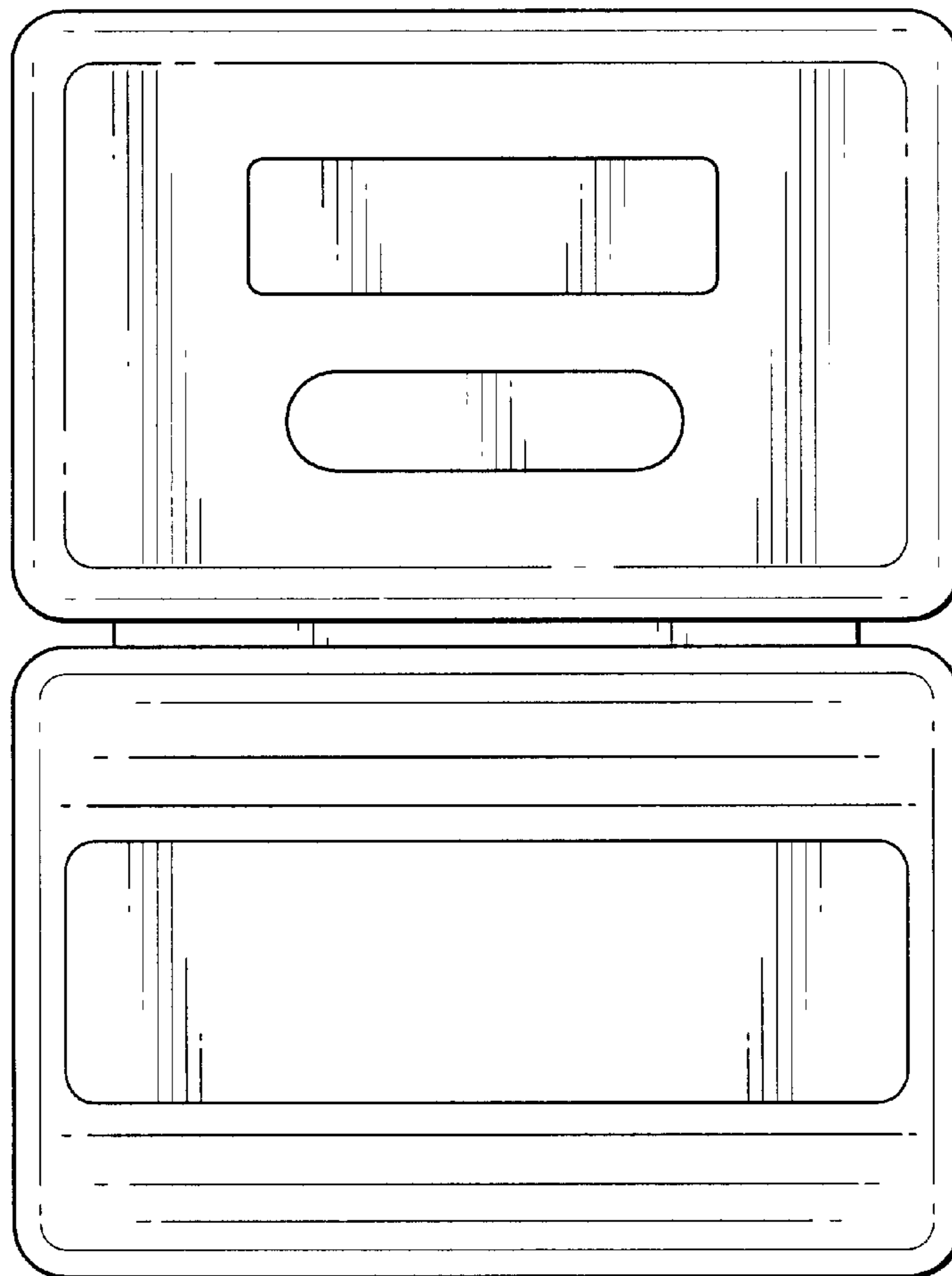

Fig. 9

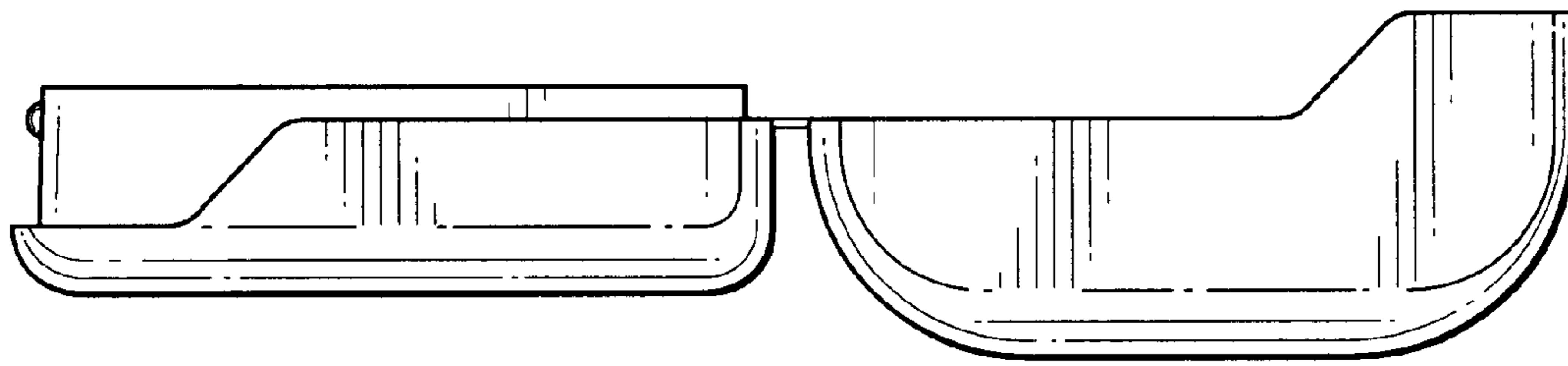

Fig. 10

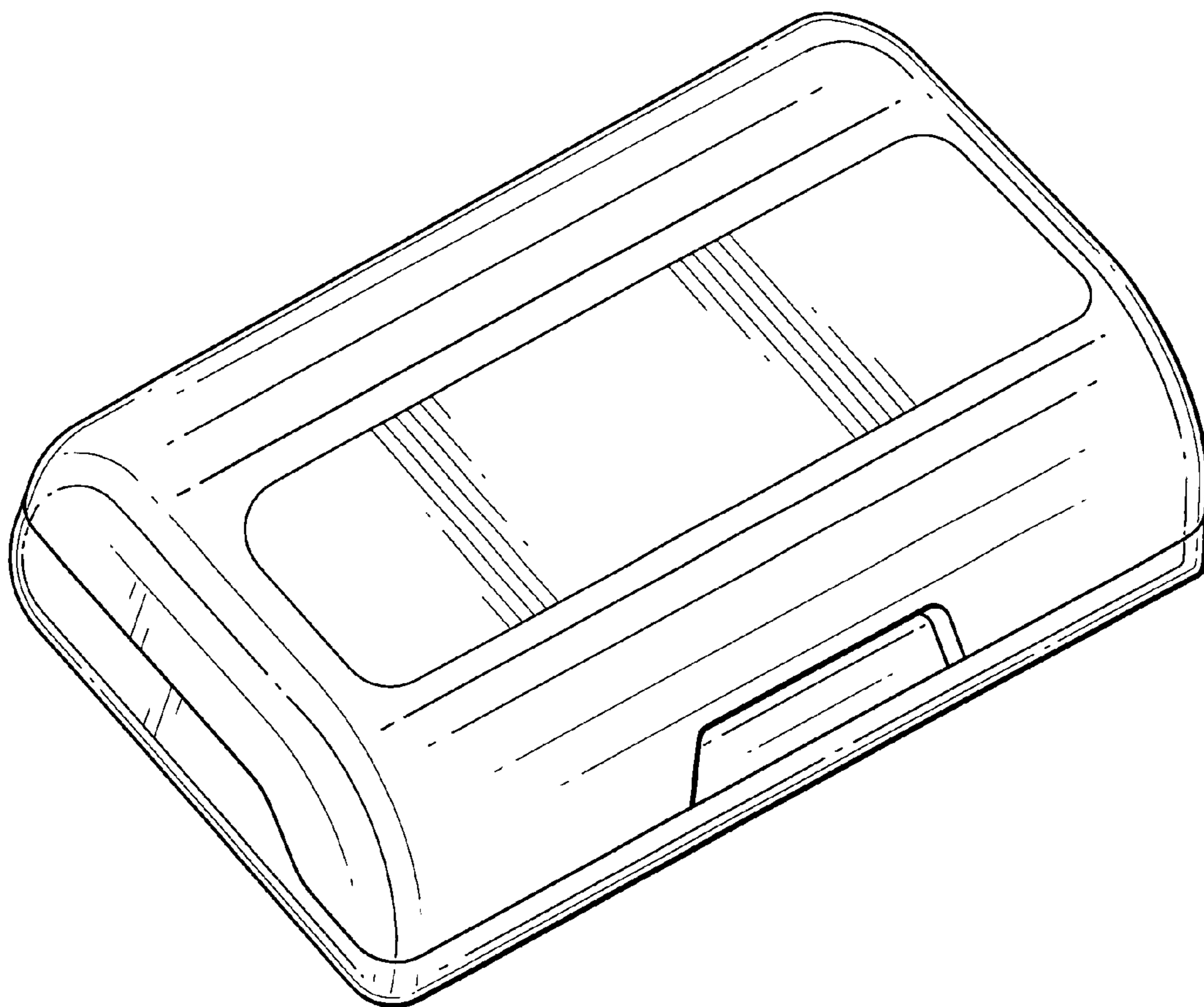

Fig. 11

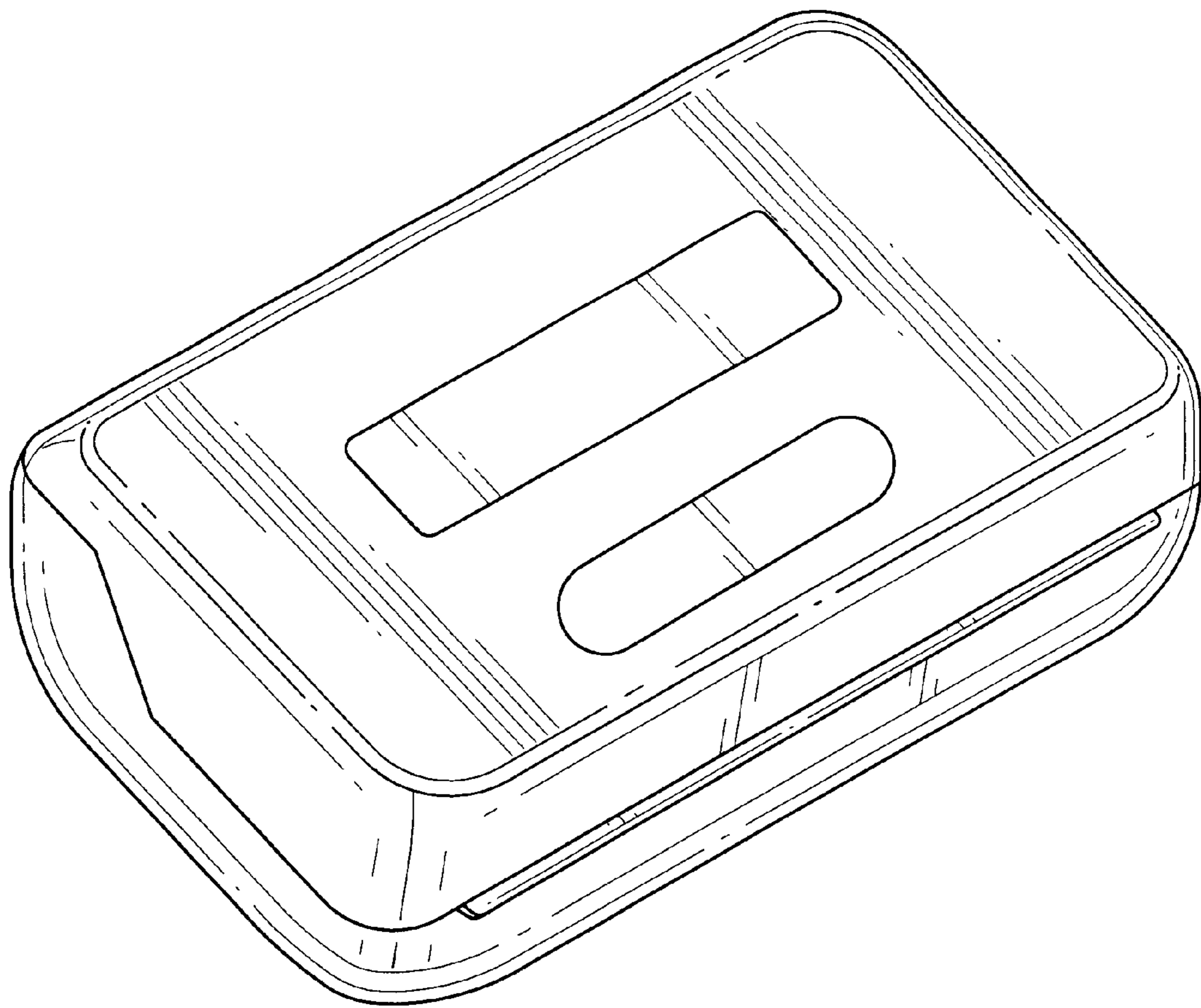

Fig. 12

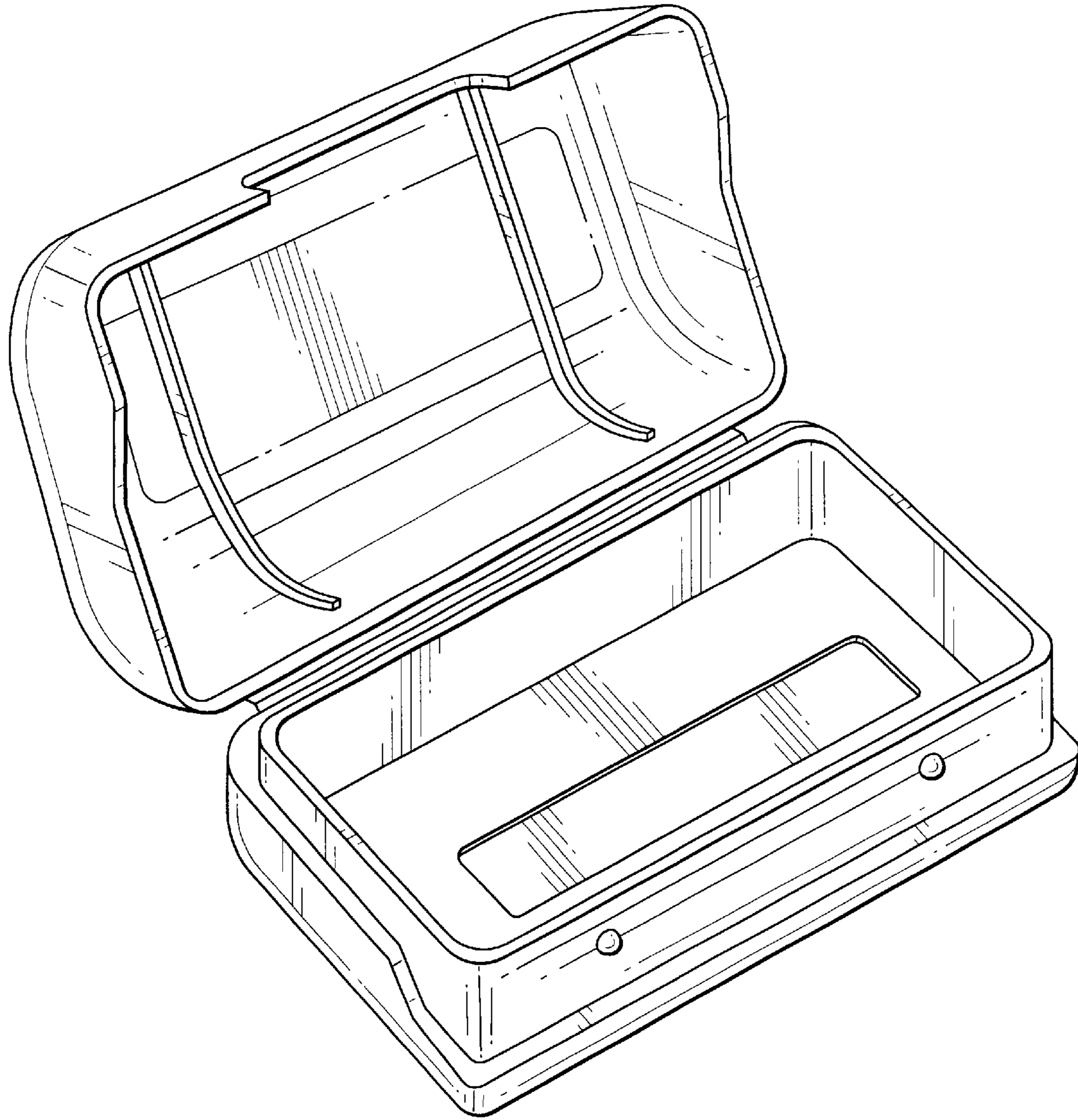

Fig. 13