



US00D506057S

(12) **United States Design Patent** (10) **Patent No.:** **US D506,057 S**
MacDonald (45) **Date of Patent:** **** Jun. 14, 2005**

(54) **KEY HOLDER**

(76) Inventor: **Sumner MacDonald**, 44 Ballou Blvd.,
Bristol, RI (US) 02809

(**) Term: **14 Years**

(21) Appl. No.: **29/196,730**

(22) Filed: **Jan. 5, 2004**

(51) **LOC (8) Cl.** **11-01**

(52) **U.S. Cl.** **D3/207**

(58) **Field of Search** D3/207-212; 206/37.1,
206/38.1; 150/147; 70/456 R, 456 B, 458-459;
24/3 K, 3.6; D16/100; D26/38

(56) **References Cited**

U.S. PATENT DOCUMENTS

D308,297 S	*	6/1990	Romano	D3/208
D378,630 S	*	4/1997	Carman	D3/207
D435,721 S	*	1/2001	Lukach	D3/215

* cited by examiner

Primary Examiner—Ralf Seifert

(74) *Attorney, Agent, or Firm*—Robert J Doherty

(57) **CLAIM**

The ornamental design for a key holder, as shown and described.

DESCRIPTION

FIG. 1 is a front perspective view of a key holder showing my new design;

FIG. 2 is a left side elevational view of FIG. 1; the right side elevational view being the mirror image thereof;

FIG. 3 is a front elevational view of FIG. 1;

FIG. 4 is a rear elevational view FIG. 1;

FIG. 5 is a top plan view of FIG. 1;

FIG. 6 is a bottom plan view of FIG. 1;

FIG. 7 is a front perspective view of FIG. 1 with one end of the key holder cord detached from the key cord retainer;

FIG. 8 is a front perspective view of a key holder showing a second embodiment of my new design wherein an alternate key holder cord is utilized, it being understood that the remaining views of this form of the invention are the same as FIGS. 2-7 with the exception of the cord style;

FIG. 9 is a front perspective view of a key holder showing a third embodiment of my new design;

FIG. 10 is a left side elevational view of FIG. 9; the right side elevational view being the mirror image thereof;

FIG. 11 is a front elevational view of FIG. 9;

FIG. 12 is a rear elevational view of FIG. 9;

FIG. 13 is a top plan view of FIG. 9;

FIG. 14 is a bottom plan view of FIG. 9;

FIG. 15 is a front perspective view of FIG. 9 with one end of the key holder cord detached from the key cord retainer; and,

FIG. 16 is a front perspective view of a key holder showing a fourth embodiment of my new design wherein an alternate key holder cord is utilized, it being understood that the remaining views of this form of the invention are the same as FIGS. 9-15 with the exception of the cord style.

The dotted line representation of a key in FIGS. 1, 8, 9 and 16 is for information only and forms no part of the invention.

1 Claim, 11 Drawing Sheets

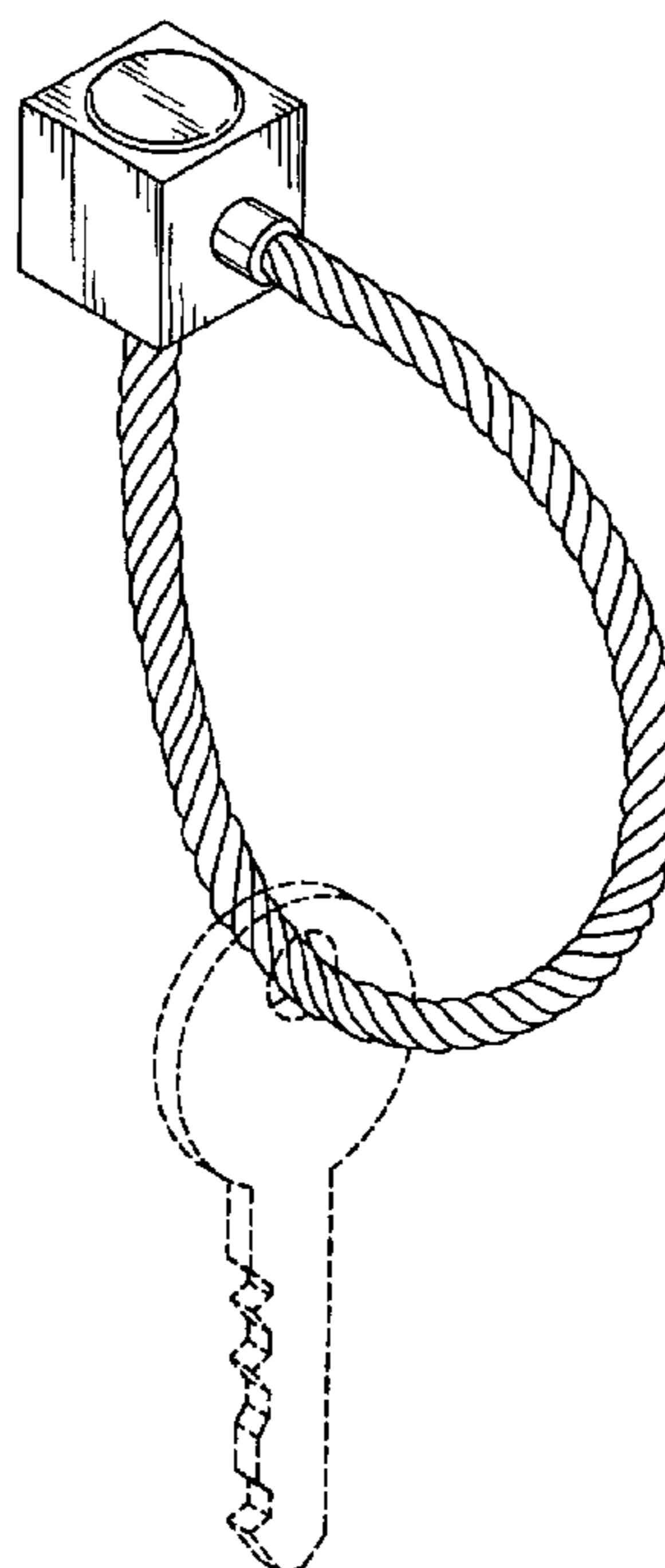

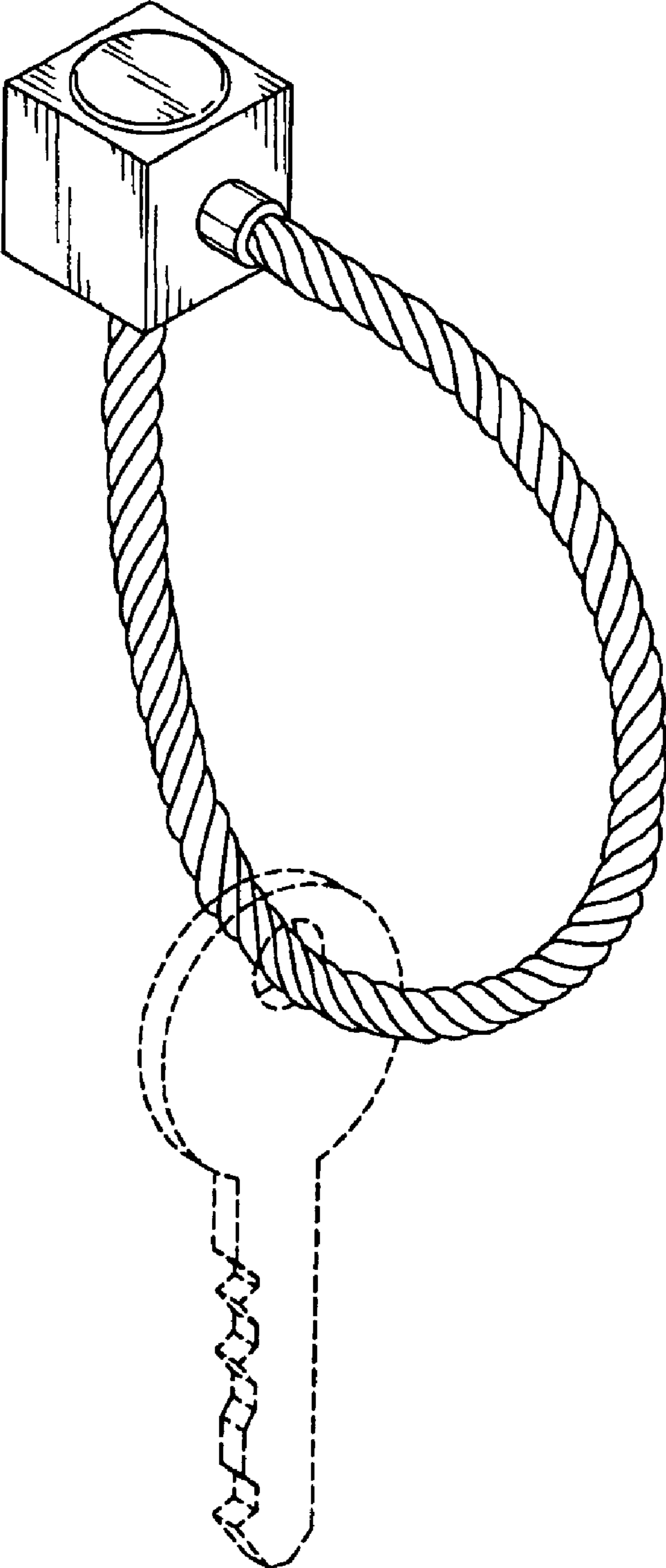

FIG. 1

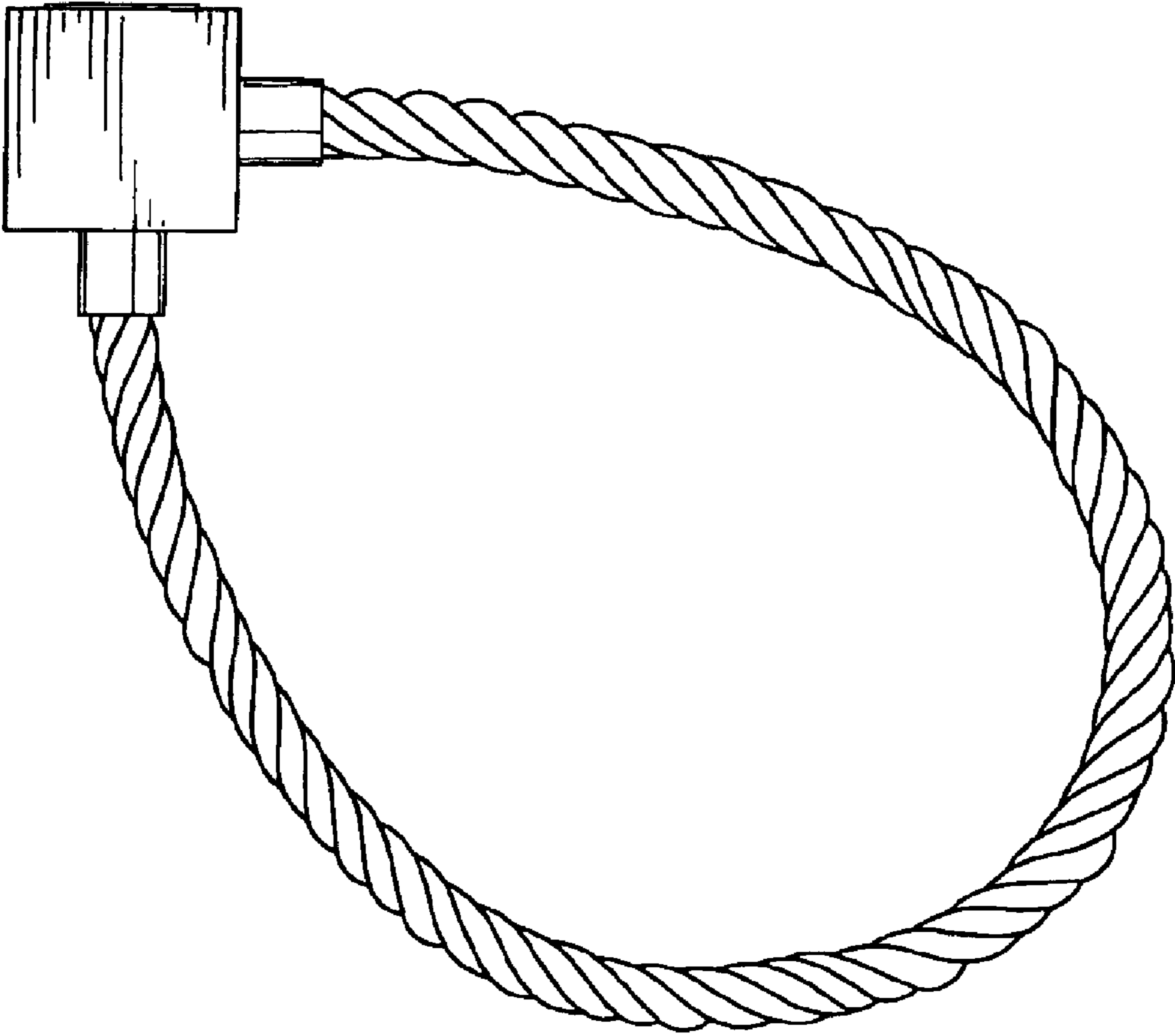

FIG. 2

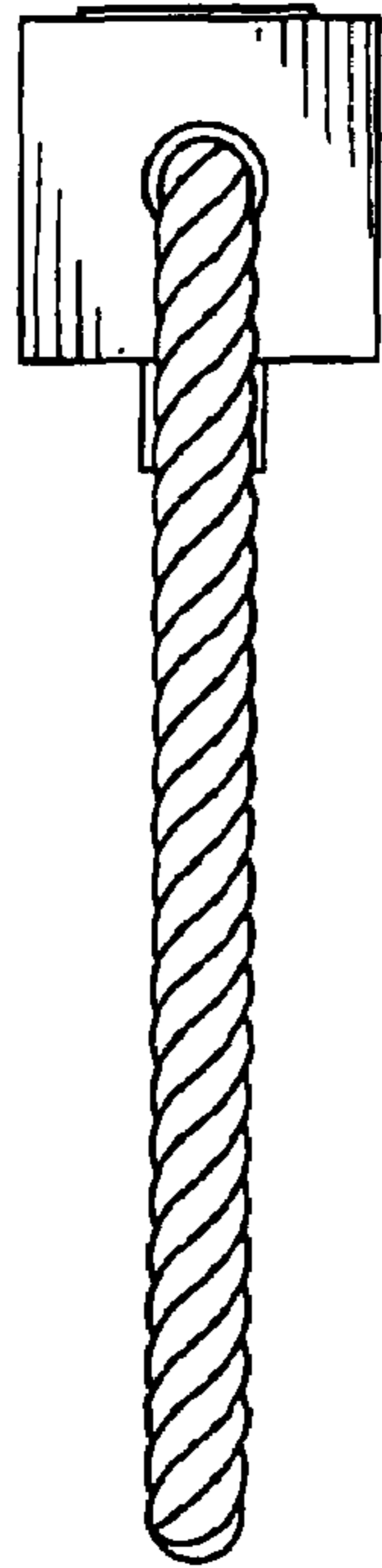

FIG. 3

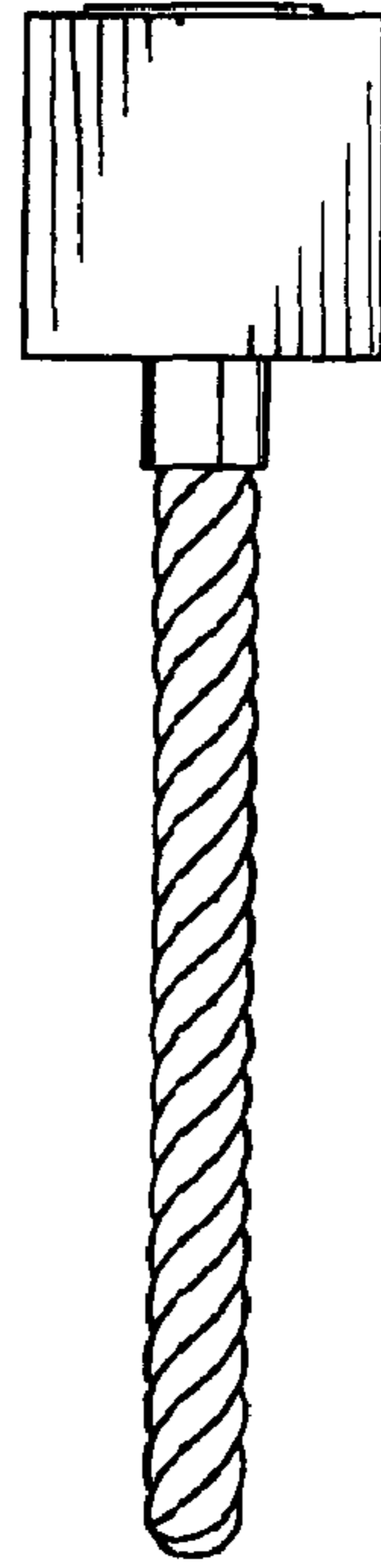

FIG. 4

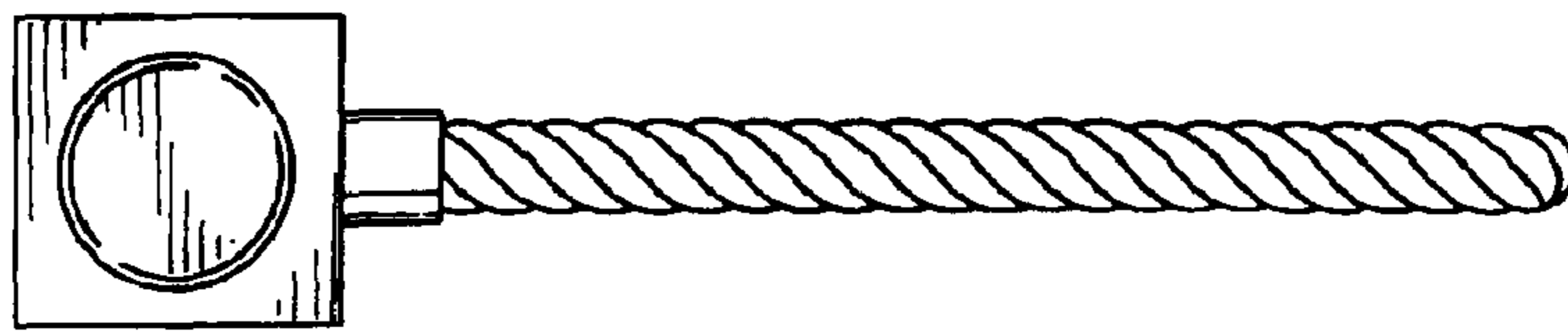

FIG. 5

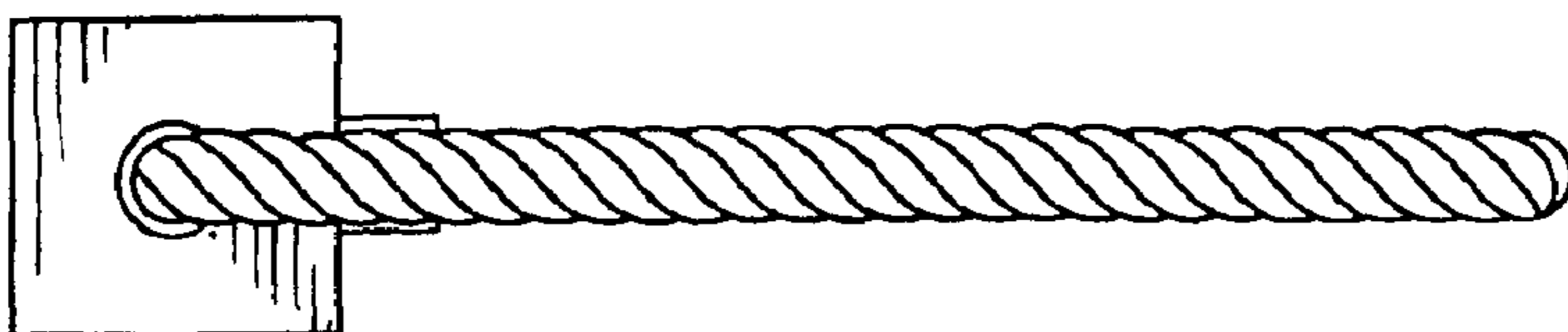

FIG. 6

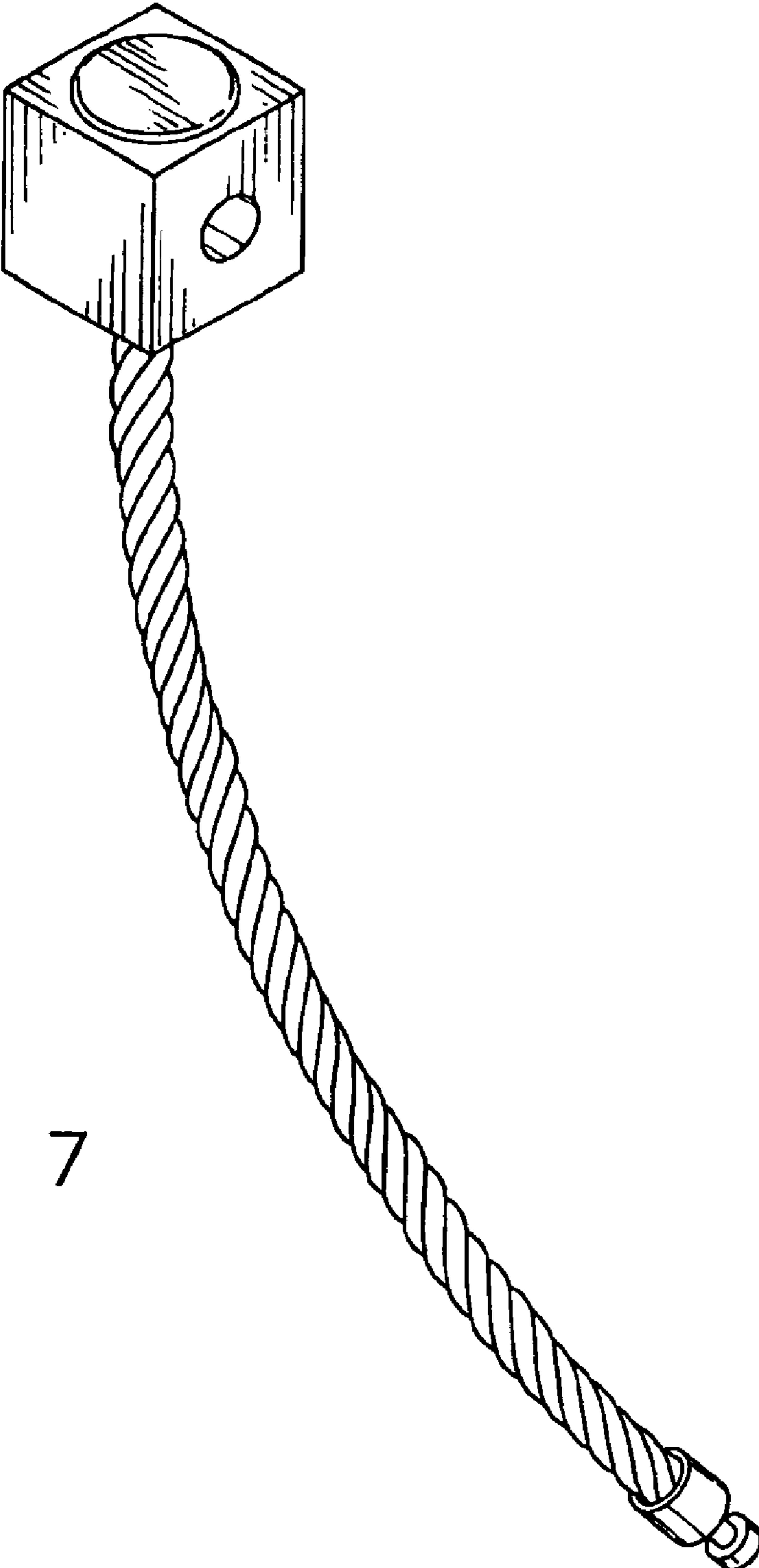

FIG. 7

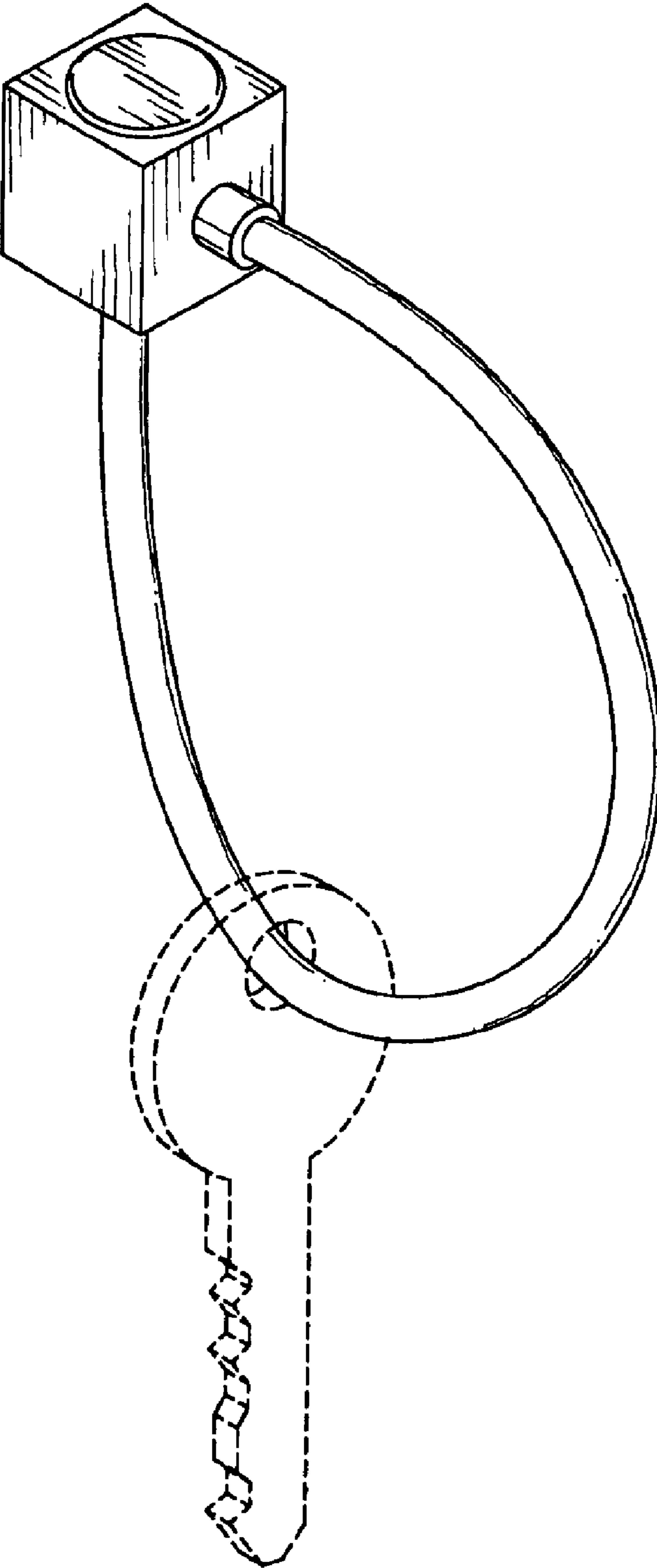

FIG. 8

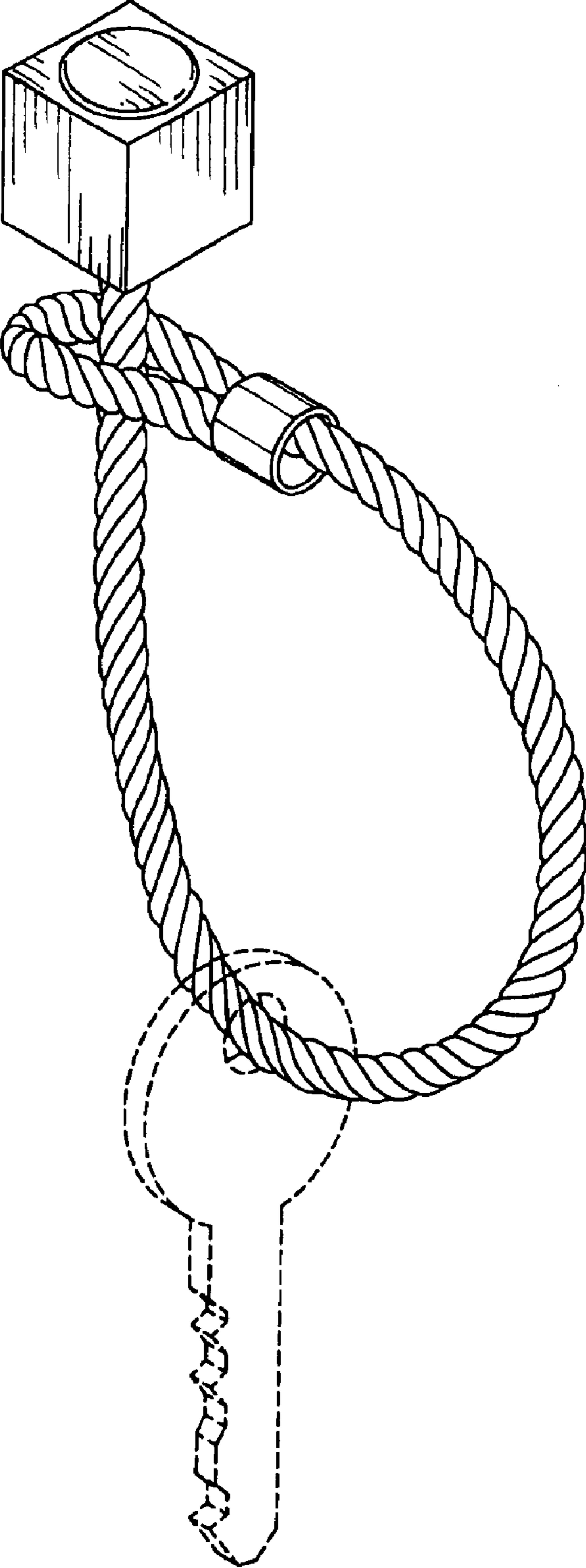

FIG. 9

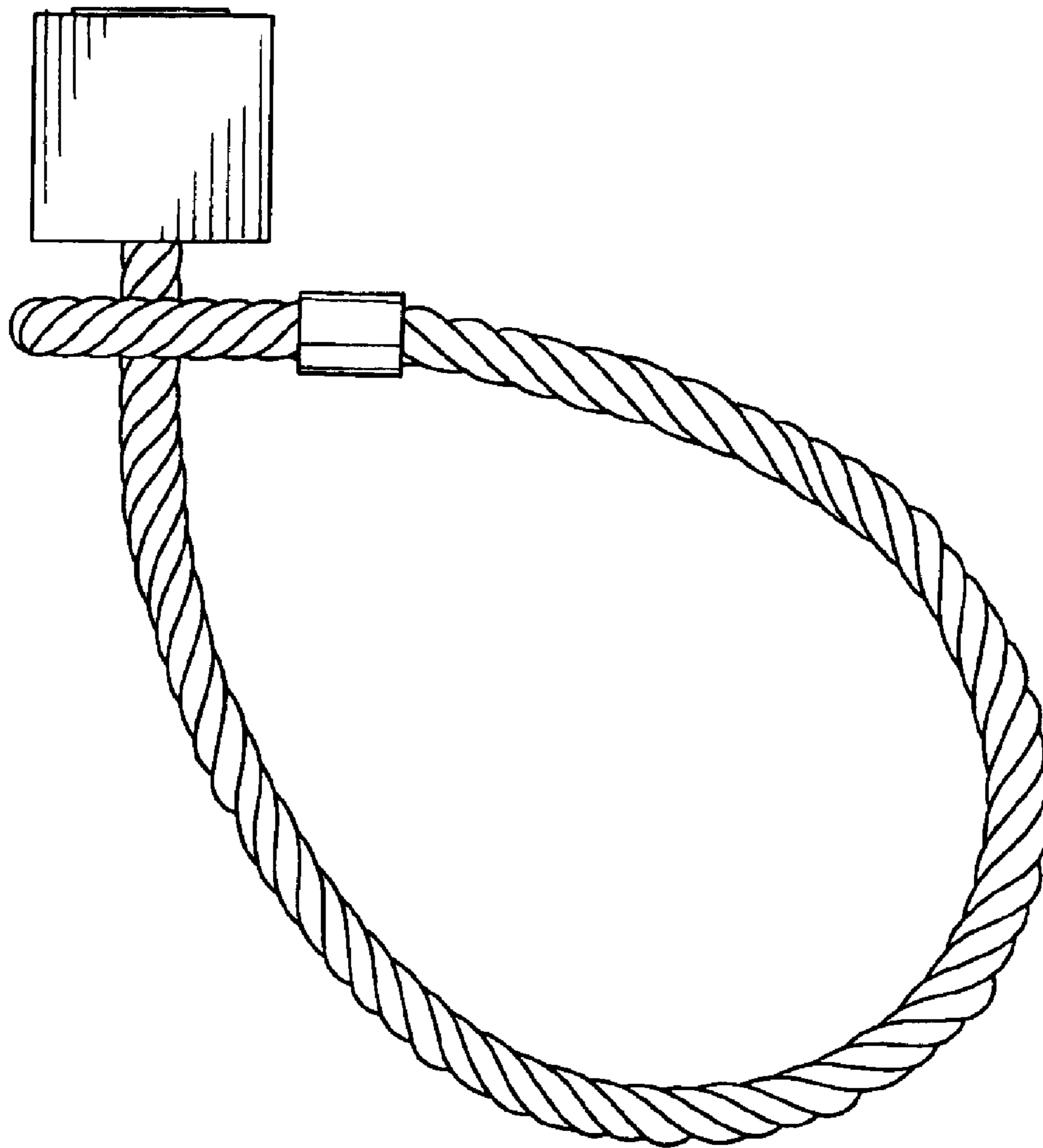

FIG. 10

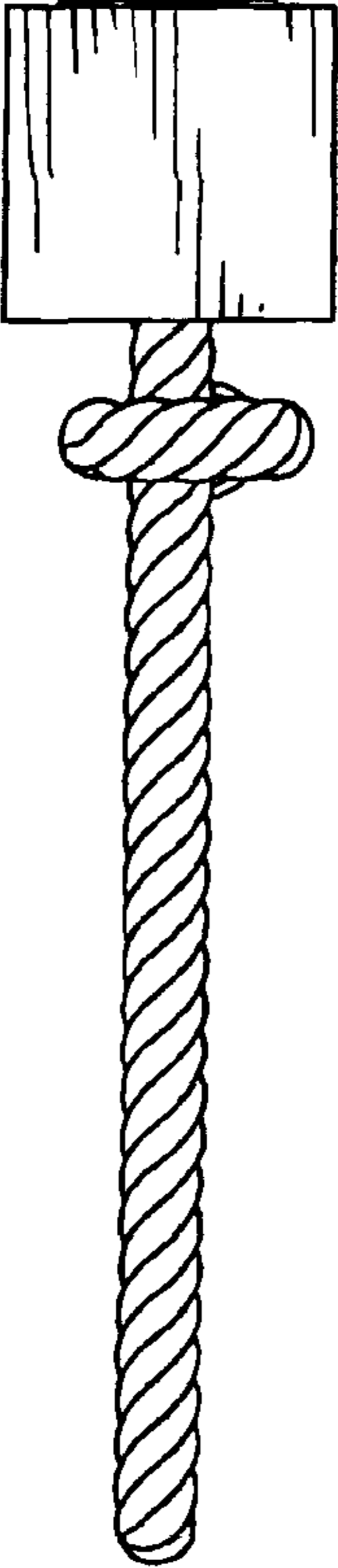

FIG. 11

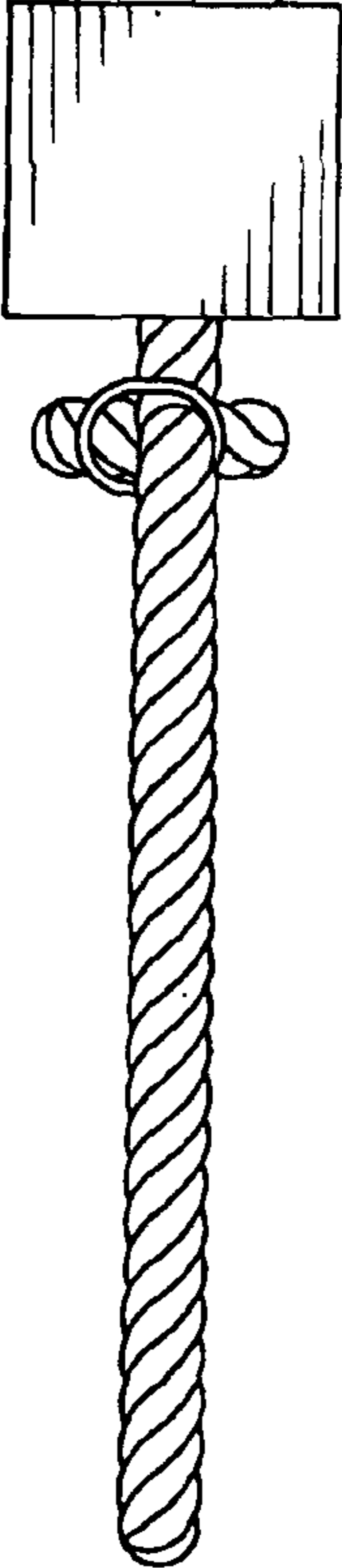

FIG. 12

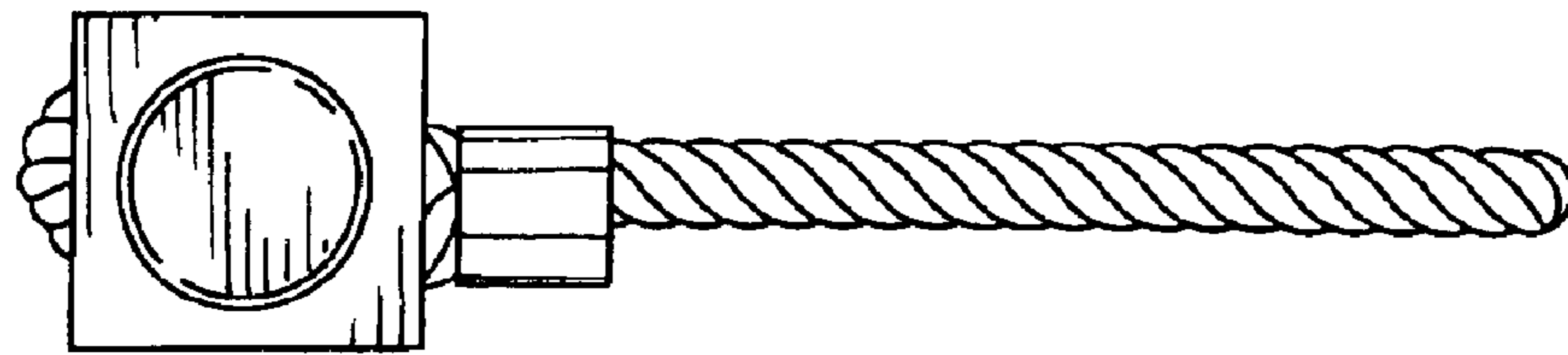

FIG. 13

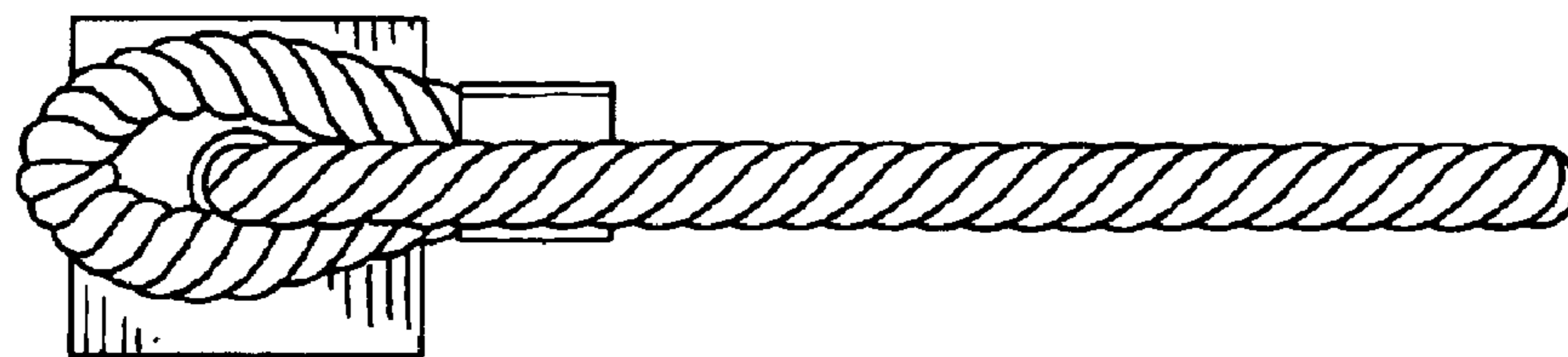

FIG. 14

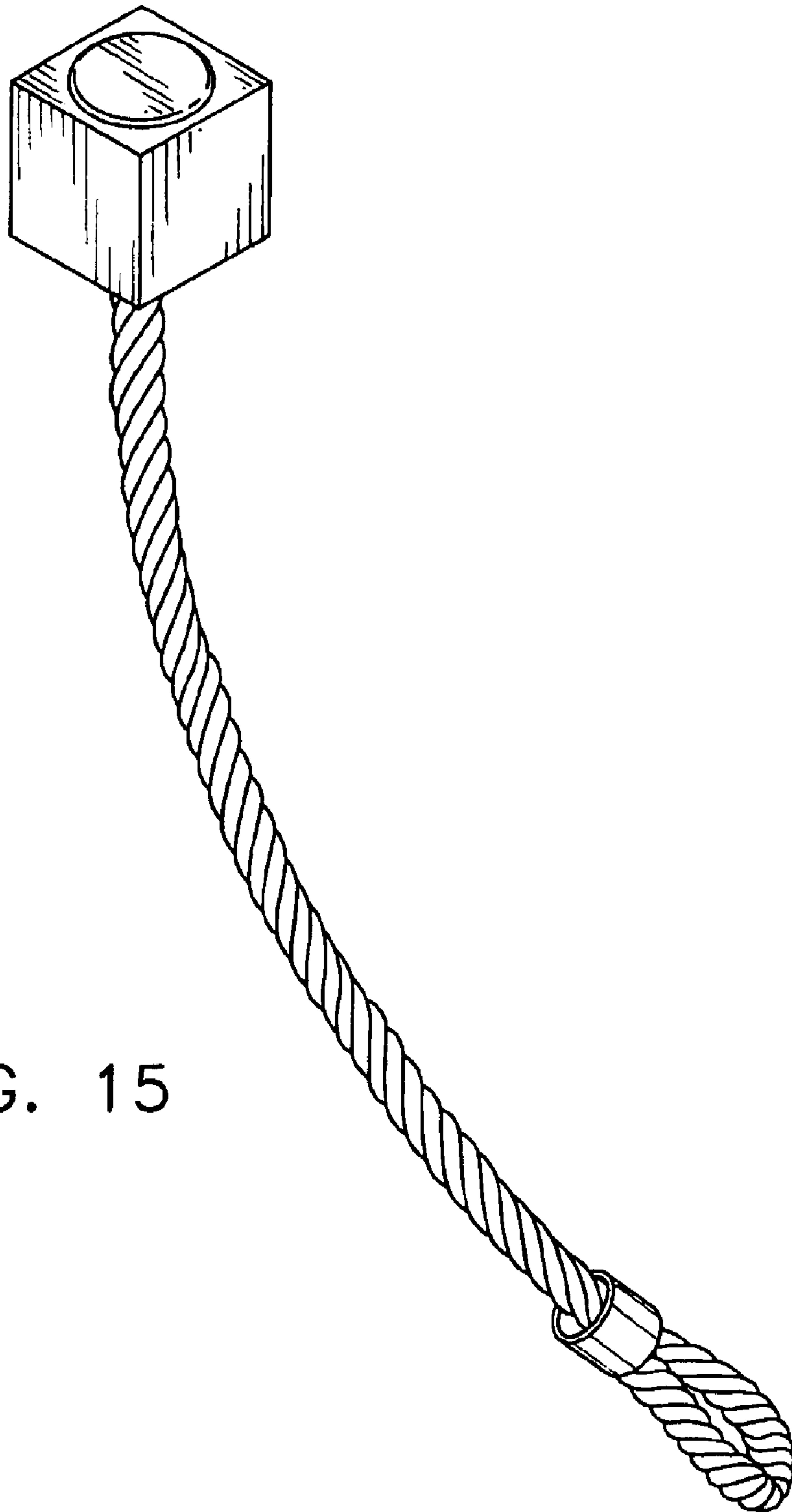

FIG. 15

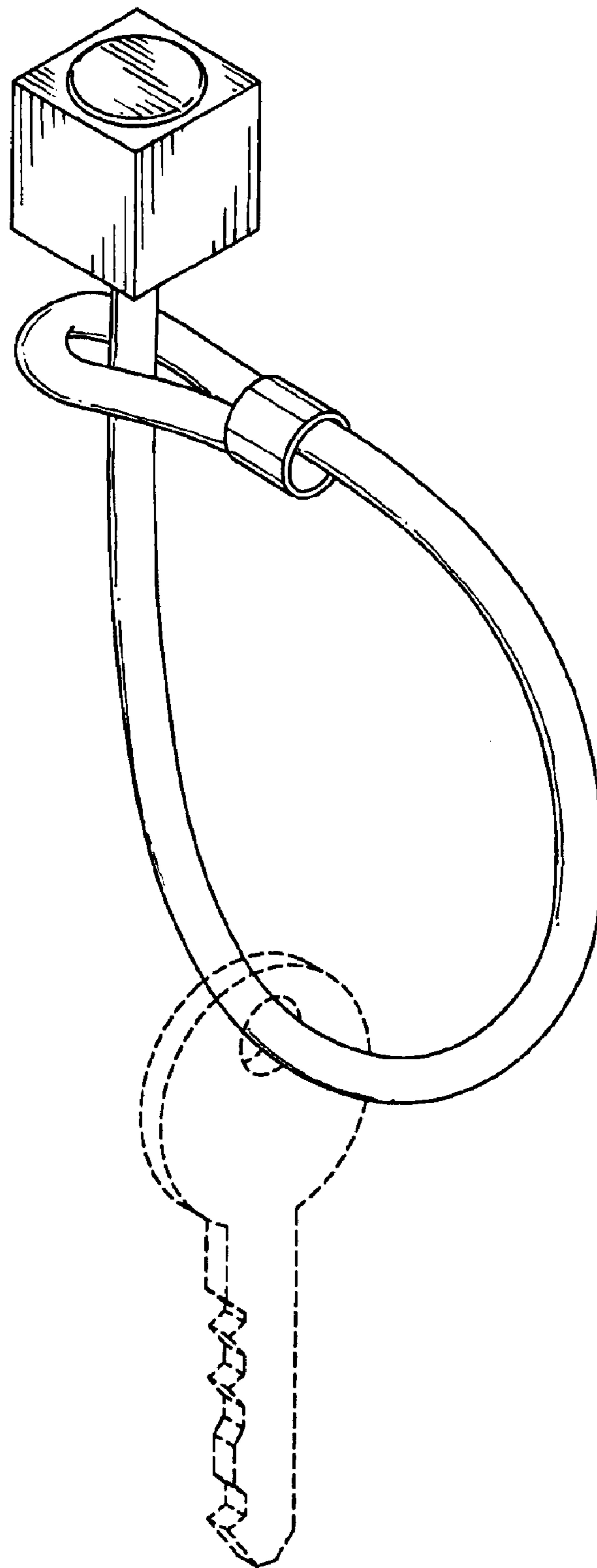

FIG. 16