

US00D506009S

(12) **United States Design Patent**
Kent et al.

(10) **Patent No.: US D506,009 S**
(45) **Date of Patent: ** Jun. 7, 2005**

- (54) **THERAPEUTIC DEVICE**
- (75) Inventors: **Marsha Kent**, Austin, TX (US); **Ron Lynch**, Austin, TX (US)
- (73) Assignee: **Sylmark Holdings Limited (IE)**
- (**) Term: **14 Years**
- (21) Appl. No.: **29/212,423**
- (22) Filed: **Aug. 31, 2004**

- 6,537,302 B1 3/2003 Thiberg
- 6,602,245 B1 8/2003 Thiberg
- 6,602,275 B1 8/2003 Sullivan
- D480,480 S 10/2003 Lomberg et al.
- D482,127 S 11/2003 Rhoades
- D484,625 S 12/2003 Chang
- 6,689,124 B1 2/2004 Thiberg
- 6,702,837 B2 3/2004 Gutwein
- 2002/0198575 A1 12/2002 Sullivan
- 2003/0187486 A1 10/2003 Savage et al.
- 2003/0199946 A1 10/2003 Gutwein
- 2004/0044384 A1 3/2004 Leber et al.
- 2004/0147984 A1 7/2004 Altshuler et al.

Related U.S. Application Data

- (62) Division of application No. 29/200,787, filed on Mar. 3, 2004.
- (51) **LOC (8) Cl. 28-03**
- (52) **U.S. Cl. D24/210; D24/209**
- (58) **Field of Search D24/209, 210;**
606/2, 1, 3, 9, 10, 13; 362/572, 800, 804;
607/88, 89, 90; D26/37

Primary Examiner—Ian Simmons

(74) *Attorney, Agent, or Firm*—Kathy Mojibi Kavcioglu

(57) **CLAIM**

We claim the ornamental design for the therapeutic device, as shown and described.

DESCRIPTION

FIG. 1 is a perspective view of a therapeutic device showing our new design, the broken line showing is for illustrative purposes only and forms no part of the claimed design;
 FIG. 2 is a top plan view thereof;
 FIG. 3 is a bottom plan view thereof;
 FIG. 4 is a side elevational view thereof;
 FIG. 5 is a front elevational view thereof; and,
 FIG. 6 is a rear elevational view thereof.
 The broken lines in the figures are for illustrative purposes only and form no part of the claimed design.

(56) **References Cited**

U.S. PATENT DOCUMENTS

- D331,288 S 11/1992 Yuen
- 5,358,503 A 10/1994 Bertwell et al.
- 5,913,883 A 6/1999 Alexander et al.
- D428,503 S 7/2000 Rann et al.
- D436,199 S 1/2001 Lam
- 6,221,095 B1 4/2001 Van Zuylen et al.
- D441,456 S 5/2001 Thiberg
- D450,389 S 11/2001 Chang
- 6,471,716 B1 10/2002 Pecukonis

1 Claim, 3 Drawing Sheets

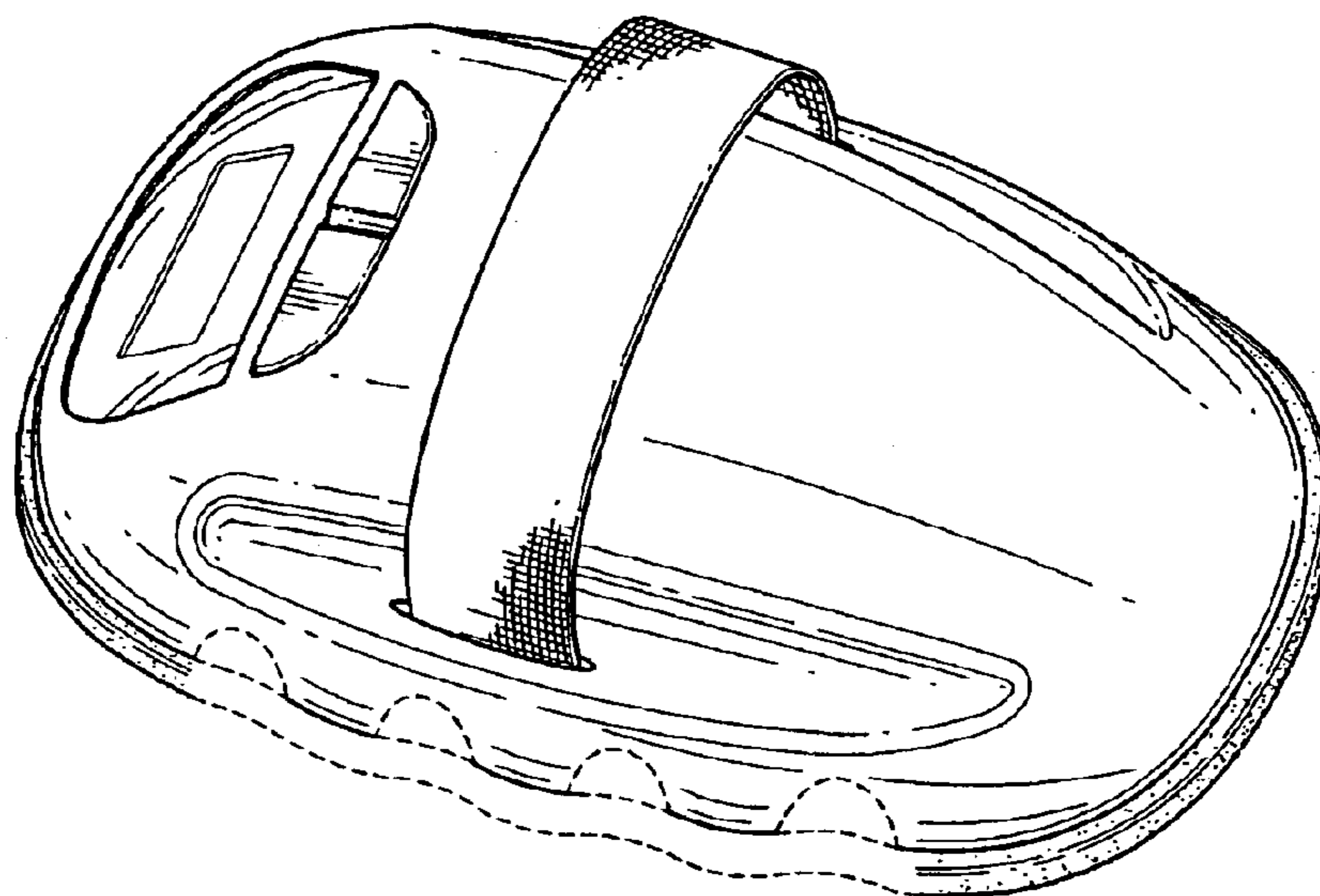

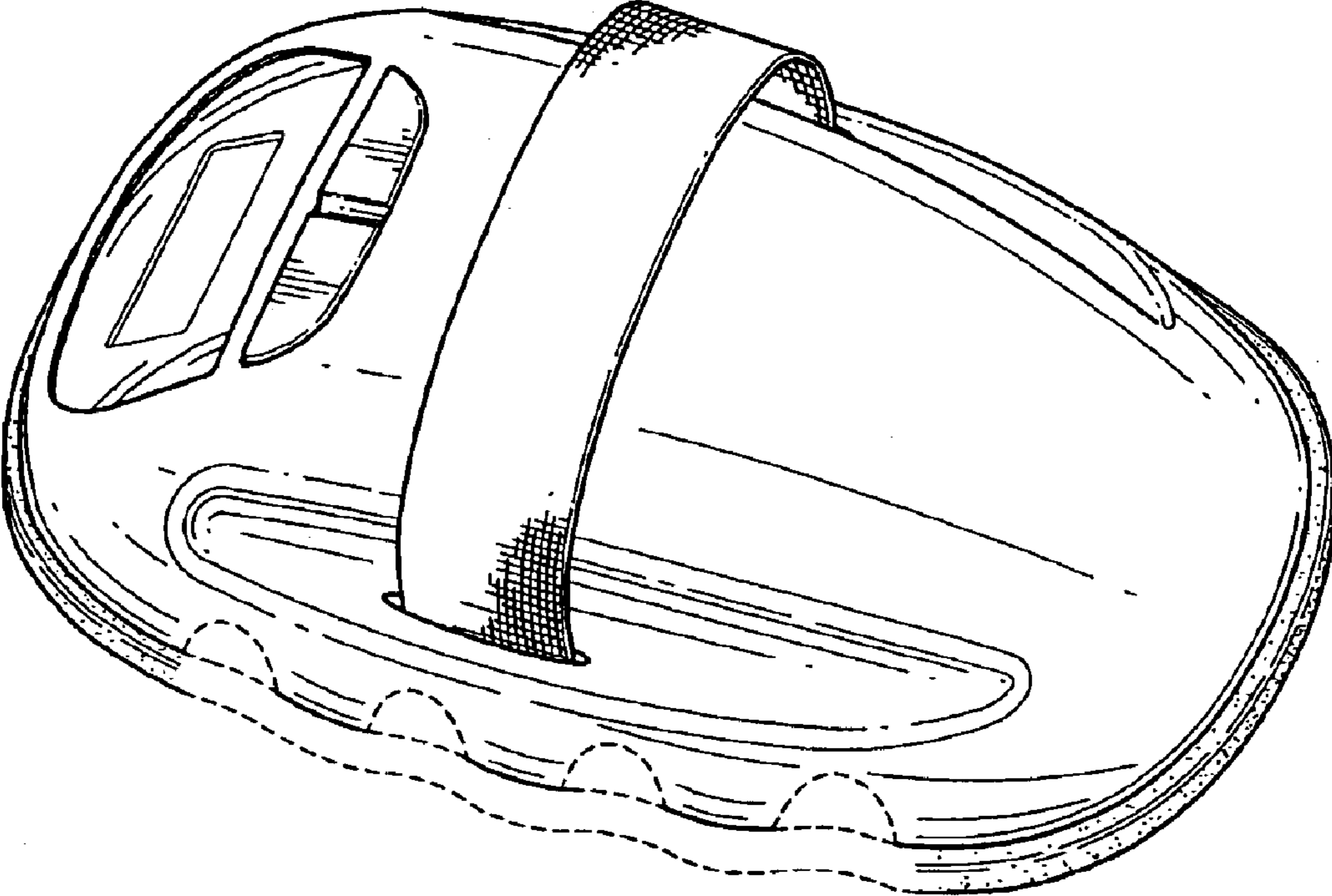

FIG. 1

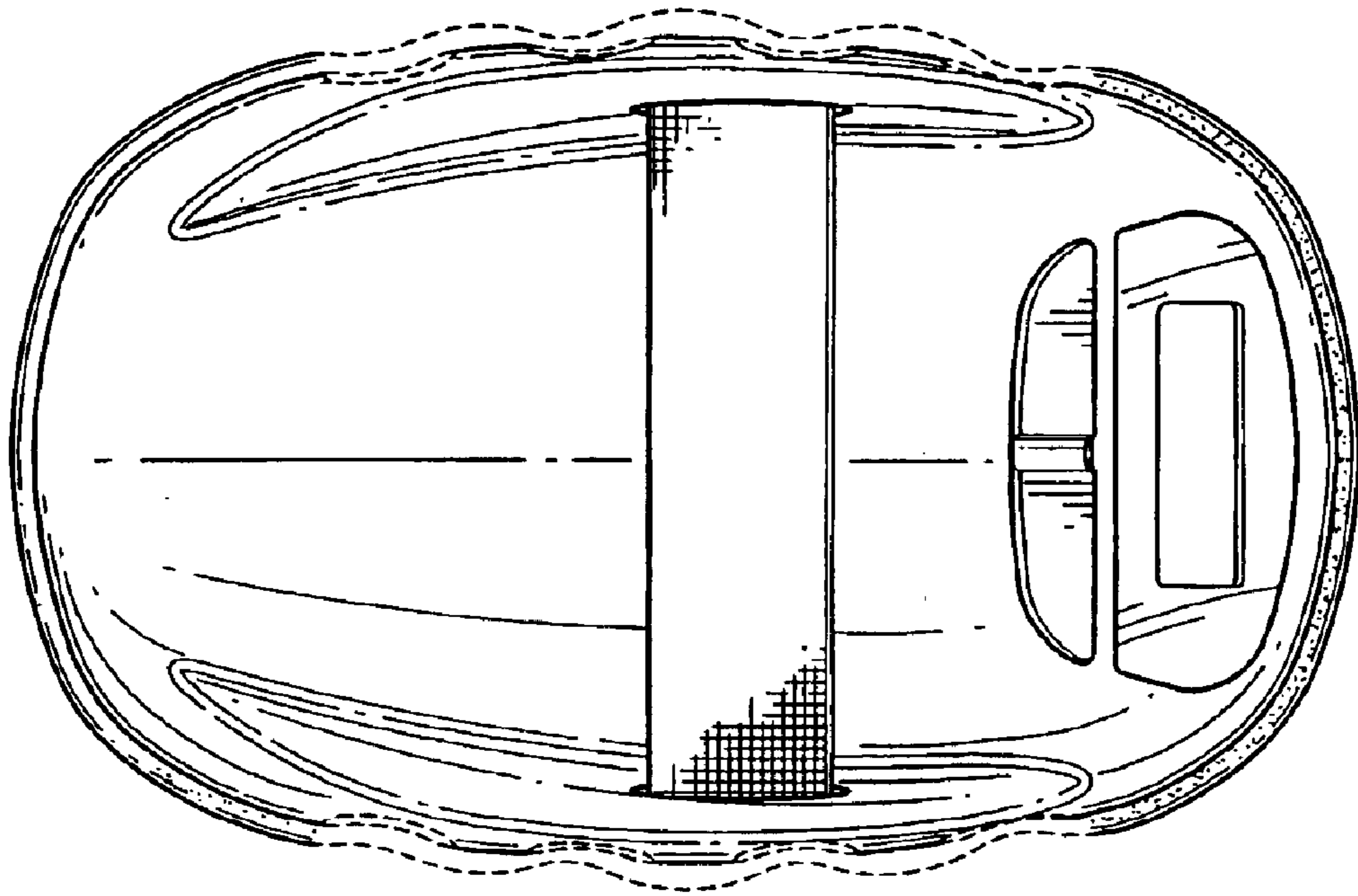

FIG. 2

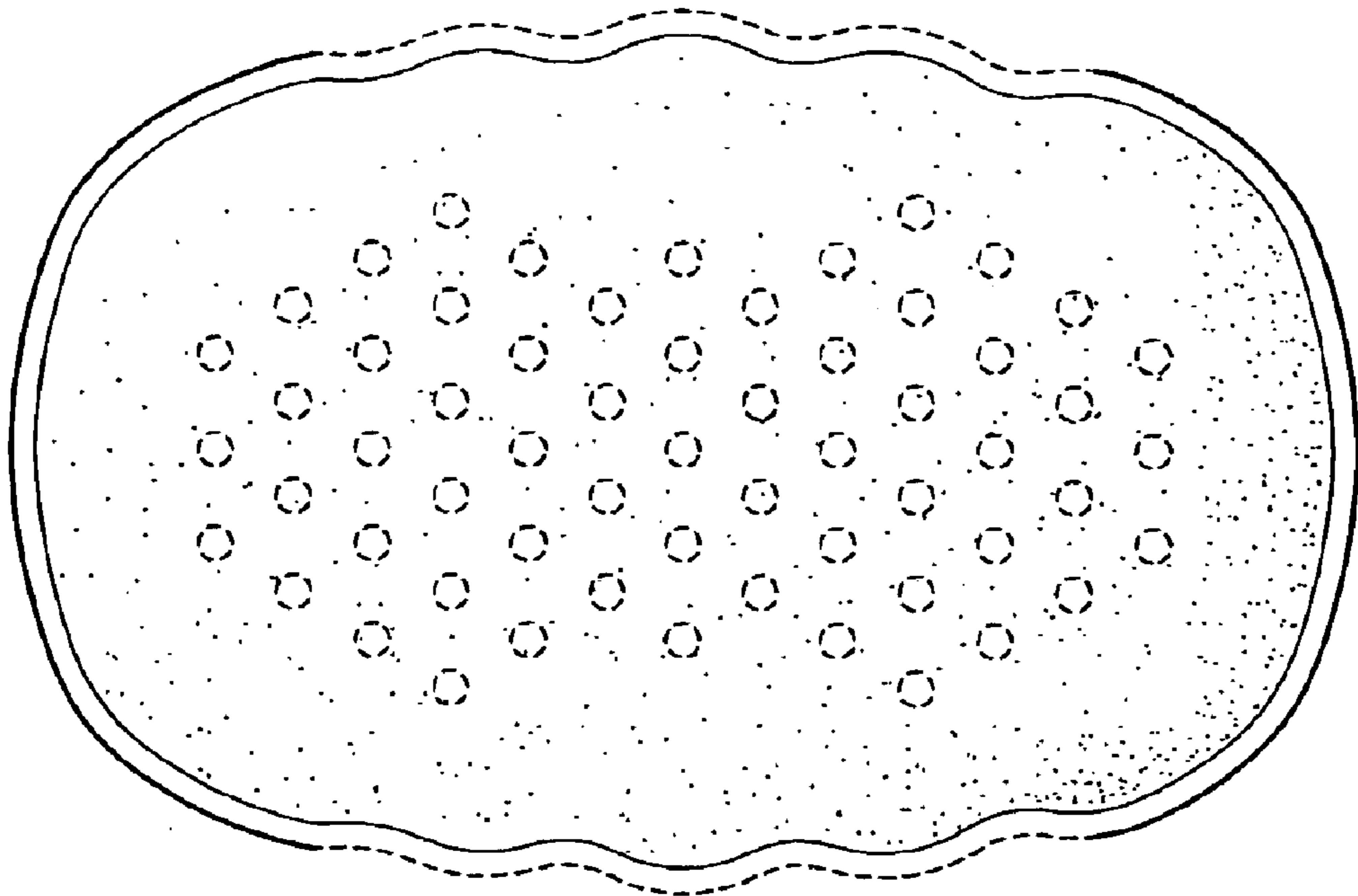

FIG. 3

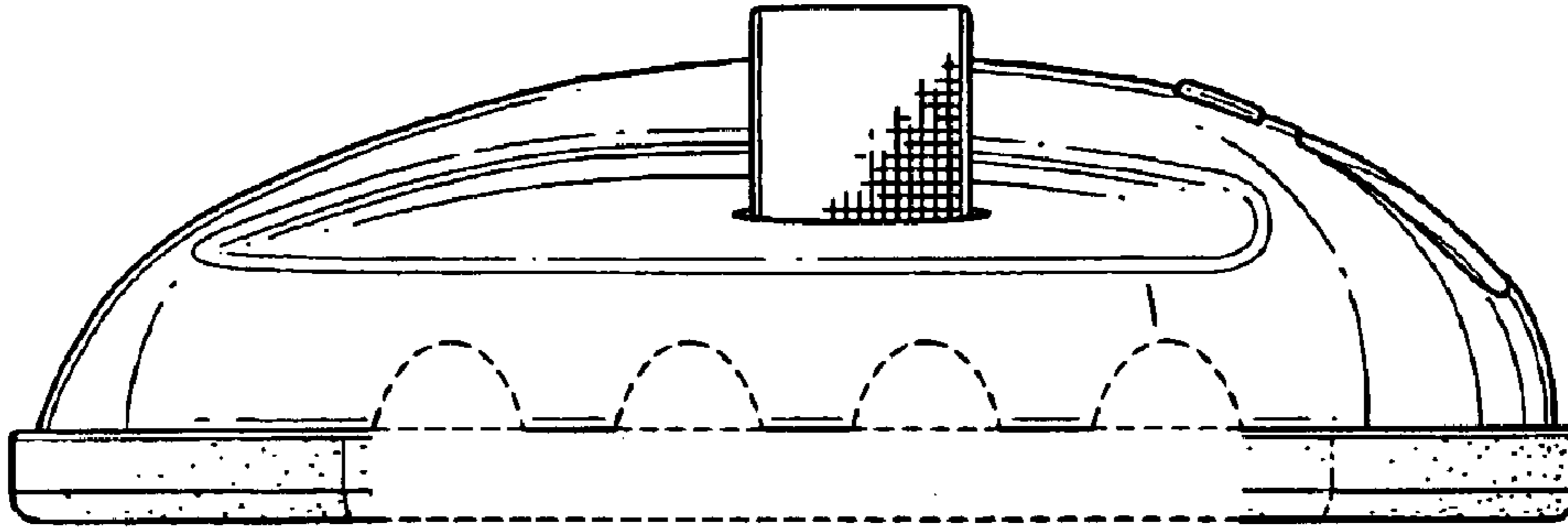

FIG. 4

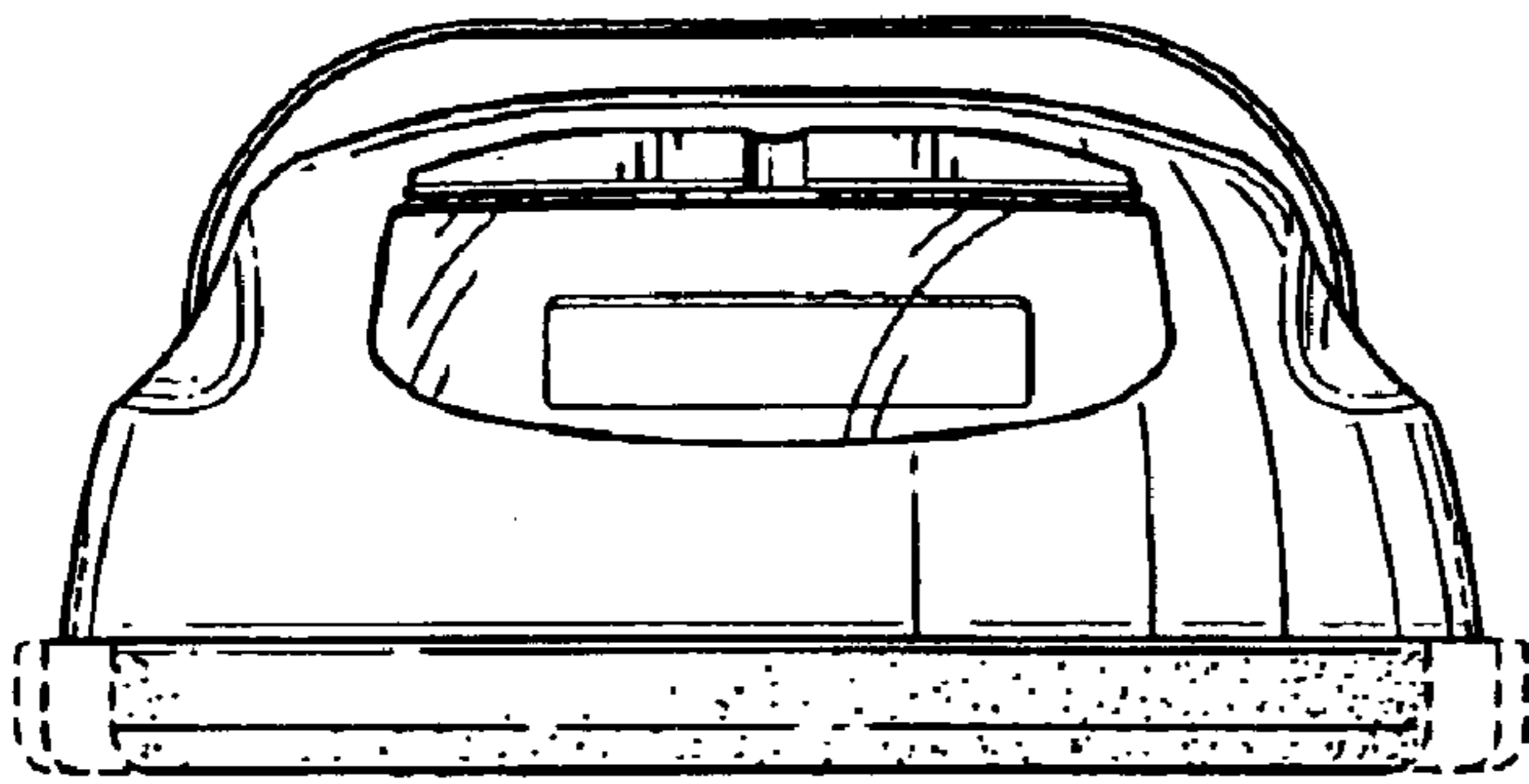

FIG. 5

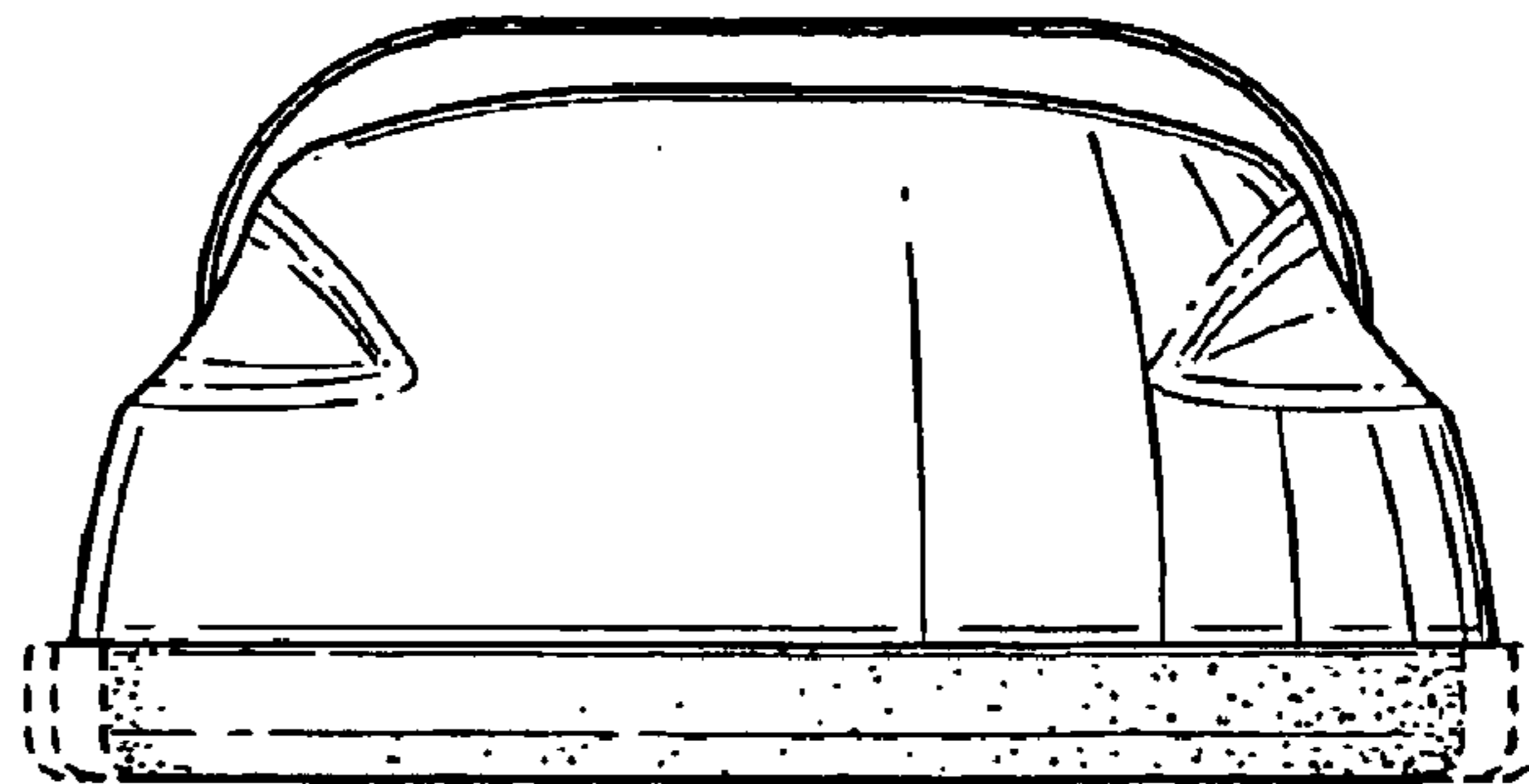

FIG. 6