

US00D506005S

(12) **United States Design Patent** (10) **Patent No.:** **US D506,005 S**
Hawley et al. (45) **Date of Patent:** **** Jun. 7, 2005**

(54) **MEDICAL DEVICE FOR THE INJECTION OF FLUID MEDICAMENTS**

(75) Inventors: **Miles Hawley**, London (GB); **Stephens Sayers**, Buckinghamshire (GB)

(73) Assignee: **Aventis Pharma Deutschland GmbH** (DE)

(**) Term: **14 Years**

(21) Appl. No.: **29/183,176**

(22) Filed: **Jun. 9, 2003**

Related U.S. Application Data

(62) Division of application No. 29/167,010, filed on Sep. 9, 2002, now Pat. No. Des. 491,263.

(30) **Foreign Application Priority Data**

Mar. 9, 2002 (DE) 402 02 271

(51) **LOC (8) Cl.** **24-02**

(52) **U.S. Cl.** **D24/114; D19/51**

(58) **Field of Search** D24/114, 113, D24/112; D19/43, 56, 51, 55; 604/157, 207, 208, 211, 218, 187, 232

(56) **References Cited**

U.S. PATENT DOCUMENTS

- D368,961 S 4/1996 Himbert et al.
- 5,728,074 A 3/1998 Castellano et al.
- D407,487 S * 3/1999 Greubel et al. D24/112
- D418,163 S 12/1999 Rosen

- 6,001,089 A * 12/1999 Burroughs et al. 604/208
- D426,299 S * 6/2000 Bydlon et al. D24/112
- 6,192,891 B1 2/2001 Gravel et al.
- 6,048,336 A1 4/2001 Gabriel
- 6,221,046 B1 * 4/2001 Burroughs et al. 604/207
- 6,277,099 B1 8/2001 Strowe et al.
- D453,569 S 2/2002 Himbert
- D460,484 S 7/2002 Bianco, Jr.
- 6,419,661 B1 * 7/2002 Kuhr et al. 604/207
- D462,760 S * 9/2002 Ahlgrim et al. D24/114
- D473,590 S * 4/2003 Mittersinker D19/57

* cited by examiner

Primary Examiner—Ian Simmons

(74) *Attorney, Agent, or Firm*—Finnegan, Henderson, Farabow, Garrett & Dunner, LLP

(57) **CLAIM**

The ornamental design for the medical device for the injection of fluid medicaments, as shown and described.

DESCRIPTION

FIG. 1 is a right side view of the medical device for the injection of fluid medicaments of our new design, the left side view being a mirror image thereof;
 FIG. 2 is a right side view of our new design, with an end cap removed, the portion of the device shown in dashed lines forming no part of the claimed design;
 FIG. 3 is a front view of our new design;
 FIG. 4 is the rear view of our new design;
 FIG. 5 is a perspective view of our new design;
 FIG. 6 is a top view of our new design; and,
 FIG. 7 is a bottom view of our new design.

1 Claim, 6 Drawing Sheets

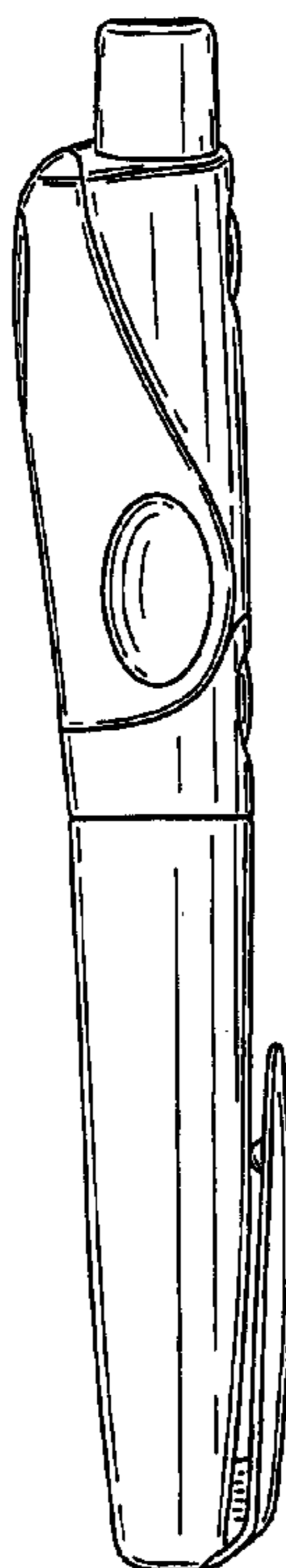

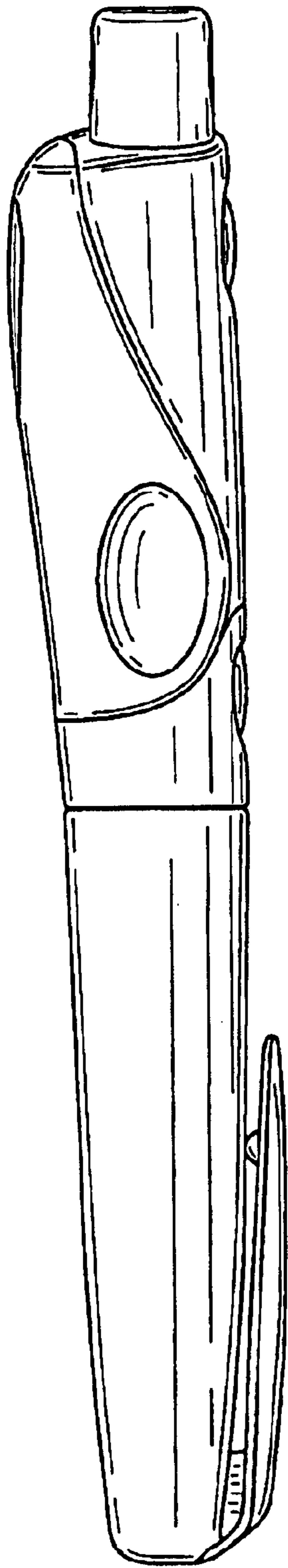

FIG. 1

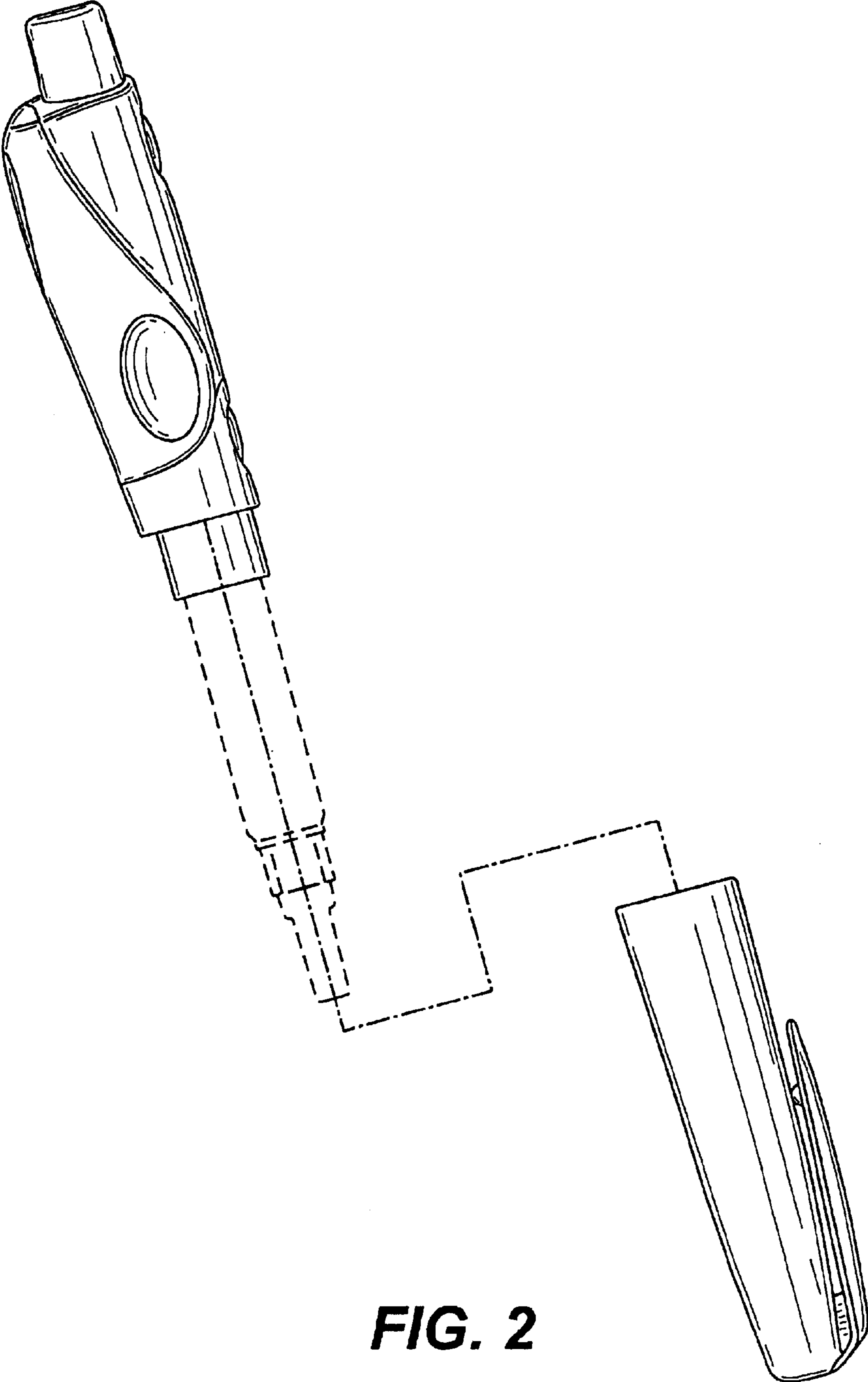

FIG. 2

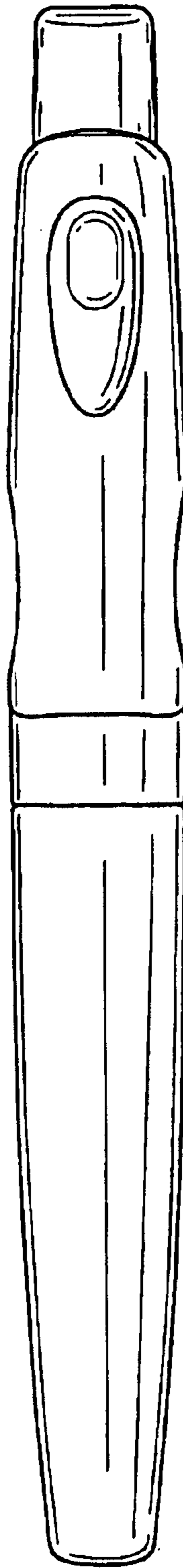

FIG. 3

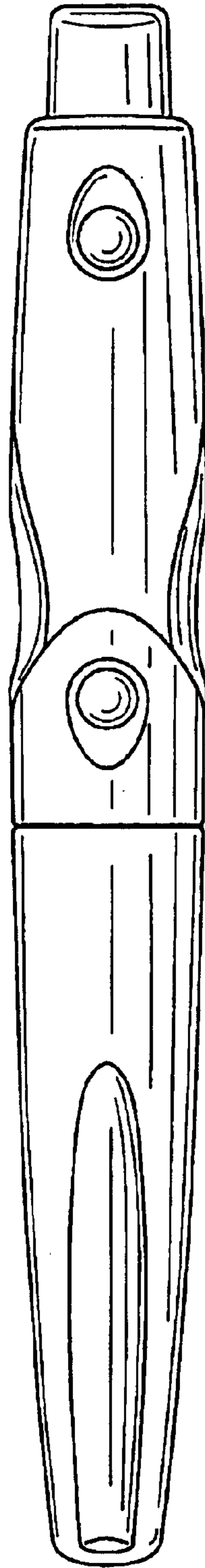

FIG. 4

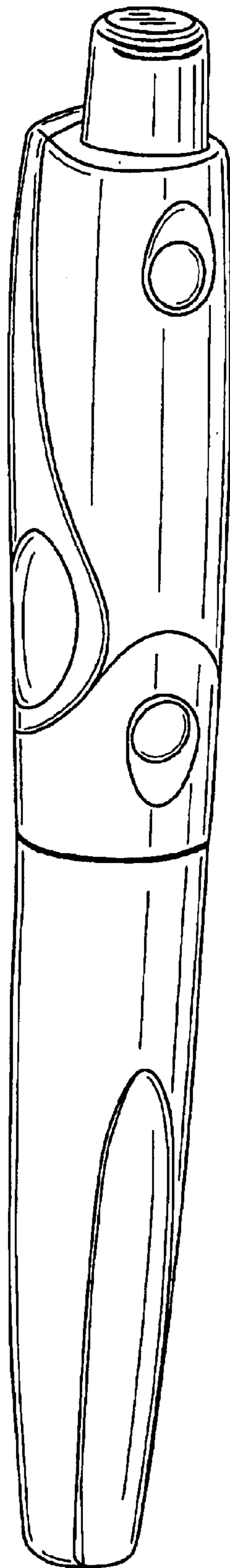

FIG. 5

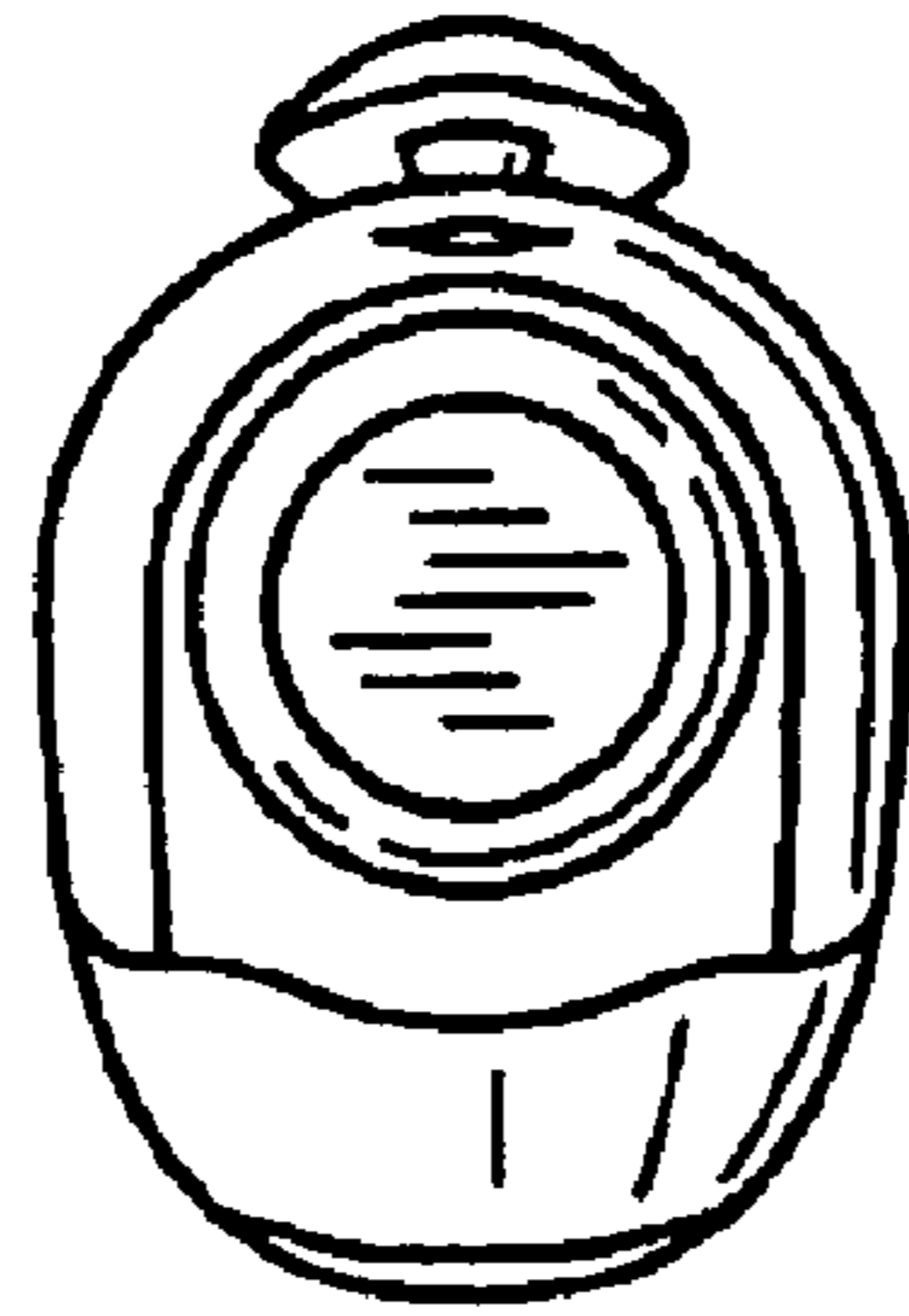

FIG. 6

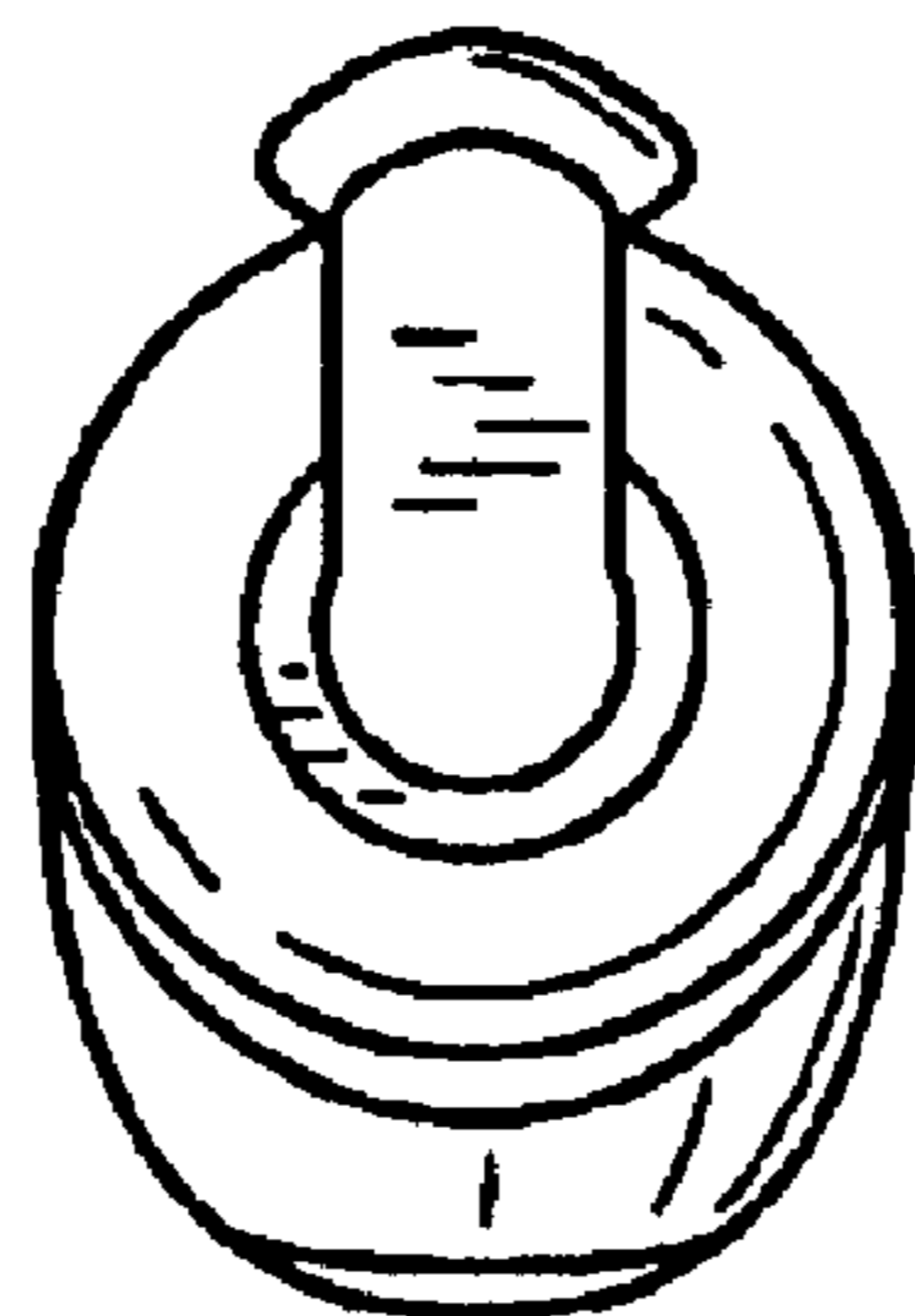

FIG. 7