

US00D505987S

(12) **United States Design Patent**
Peterson

(10) **Patent No.:** **US D505,987 S**

(45) **Date of Patent:** **** Jun. 7, 2005**

(54) **INFLATABLE TOWABLE VEHICLE**

(75) **Inventor:** **Leroy L. Peterson, Omaha, NE (US)**

(73) **Assignee:** **Sportsstuff, Inc., Omaha, NE (US)**

(**) **Term:** **14 Years**

(21) **Appl. No.:** **29/197,560**

(22) **Filed:** **Jan. 16, 2004**

(51) **LOC (8) Cl.** **21-02**

(52) **U.S. Cl.** **D21/770; D21/803**

(58) **Field of Search** **D21/769, 770,**
D21/803, 810, 809, 801; D12/316; 441/35,
40-44, 65, 66, 129-132; 114/345, 346,
253; 472/128, 129

(56) **References Cited**

U.S. PATENT DOCUMENTS

D301,322 S	*	5/1989	Lee	D12/11
5,564,357 A	*	10/1996	Peterson	114/345
D393,038 S	*	3/1998	Peterson	D21/803
D407,775 S	*	4/1999	Peterson	D21/803
D407,778 S	*	4/1999	Peterson	D21/803

D407,780 S	*	4/1999	Peterson	D21/803
5,899,782 A	*	5/1999	Martin	441/66
D432,199 S	*	10/2000	Peterson	D21/803
6,247,984 B1	*	6/2001	Hatcher	441/66
D476,712 S	*	7/2003	Peterson	D21/803
6,648,707 B1	*	11/2003	Peterson	441/66

* cited by examiner

Primary Examiner—Lucy Lieberman

(74) *Attorney, Agent, or Firm*—Sturm & Fix LLP

(57) **CLAIM**

The ornamental design for an inflatable towable vehicle, as shown and described.

DESCRIPTION

FIG. 1 is a perspective view of the inflatable towable vehicle showing my new design;
FIG. 2 is a right side elevational view thereof;
FIG. 3 is a left side elevational view thereof;
FIG. 4 is a front elevational view thereof;
FIG. 5 is a rear elevational view thereof;
FIG. 6 is a top plan view thereof; and,
FIG. 7 is a bottom plan view thereof.

1 Claim, 3 Drawing Sheets

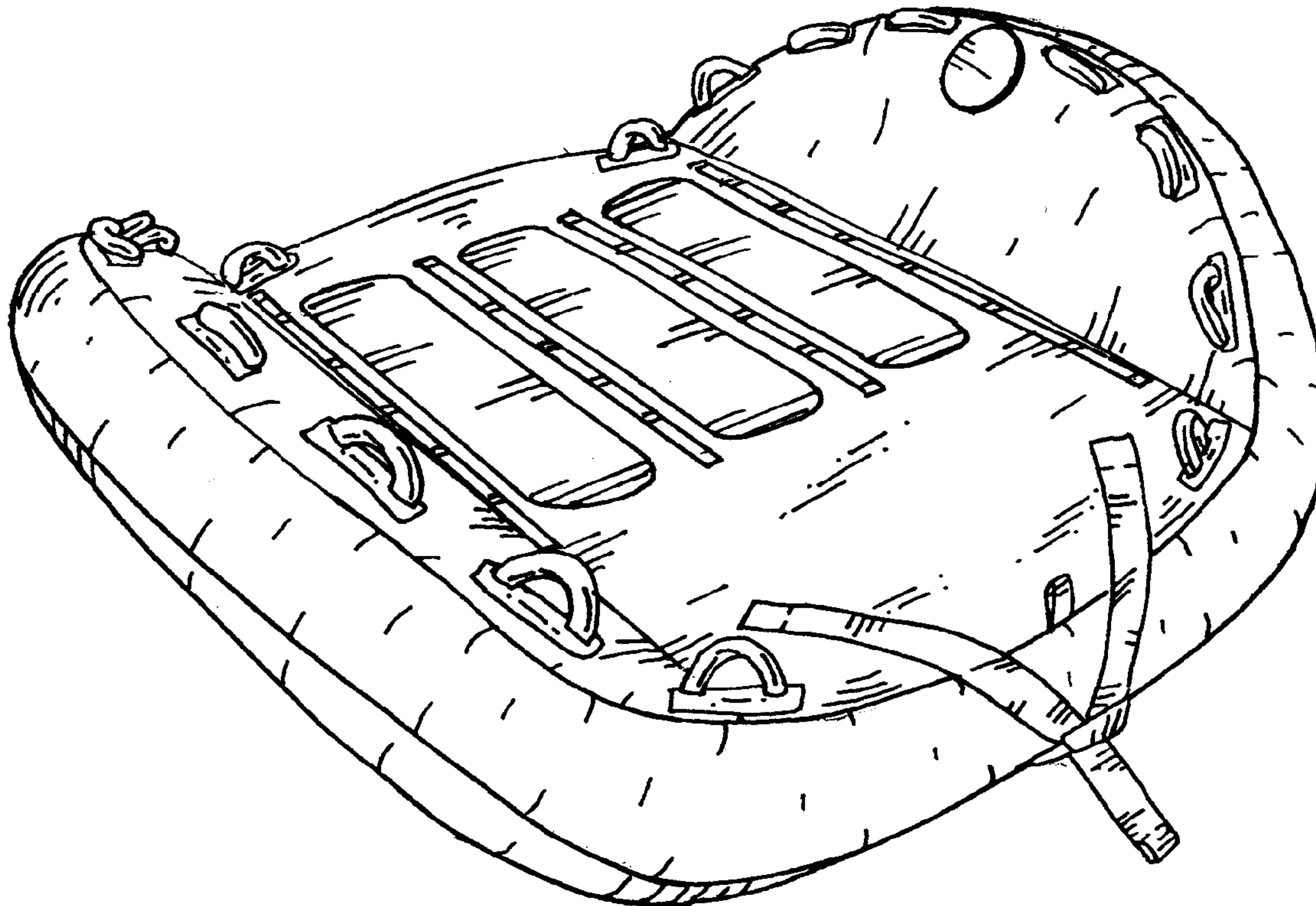

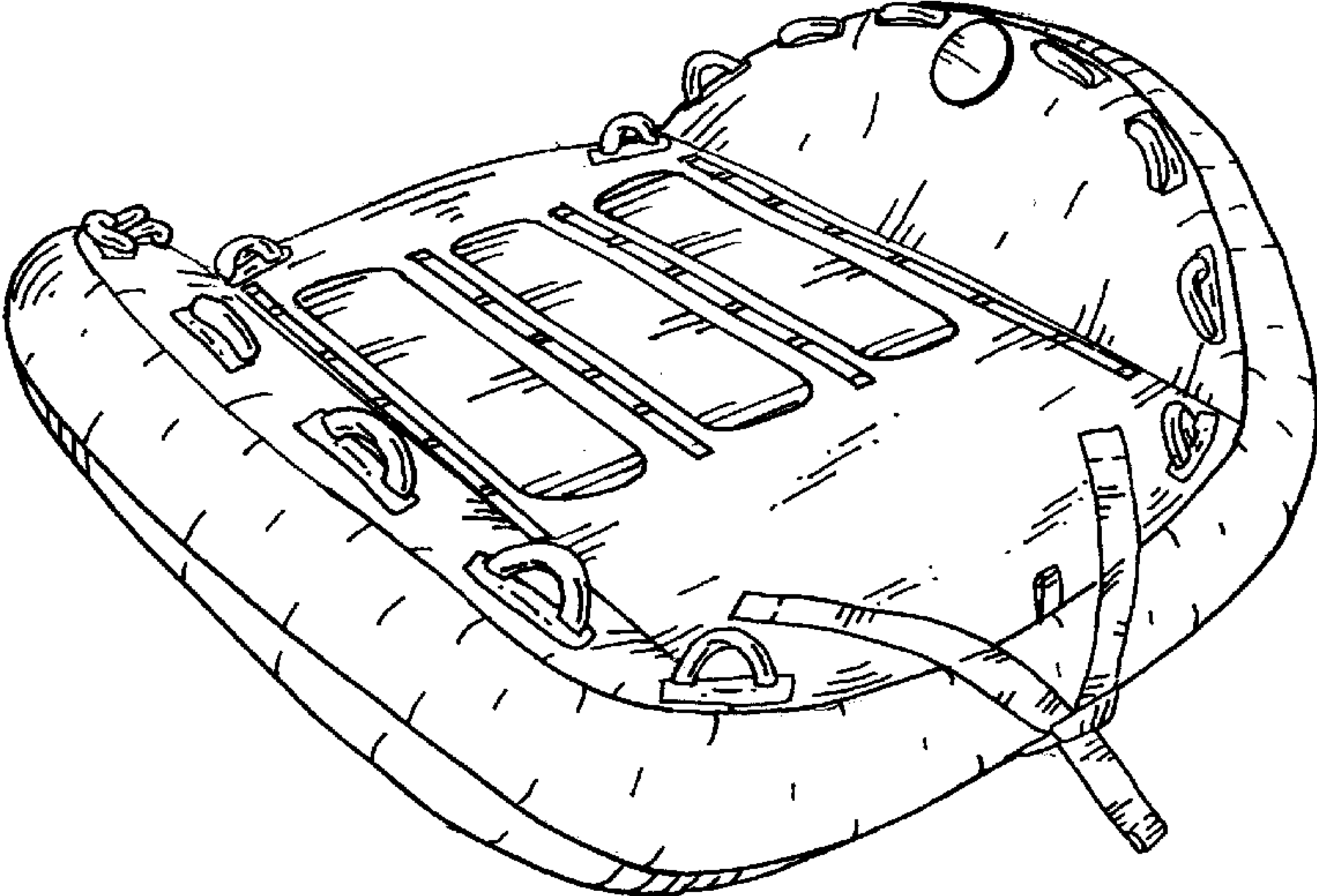

Fig. 1

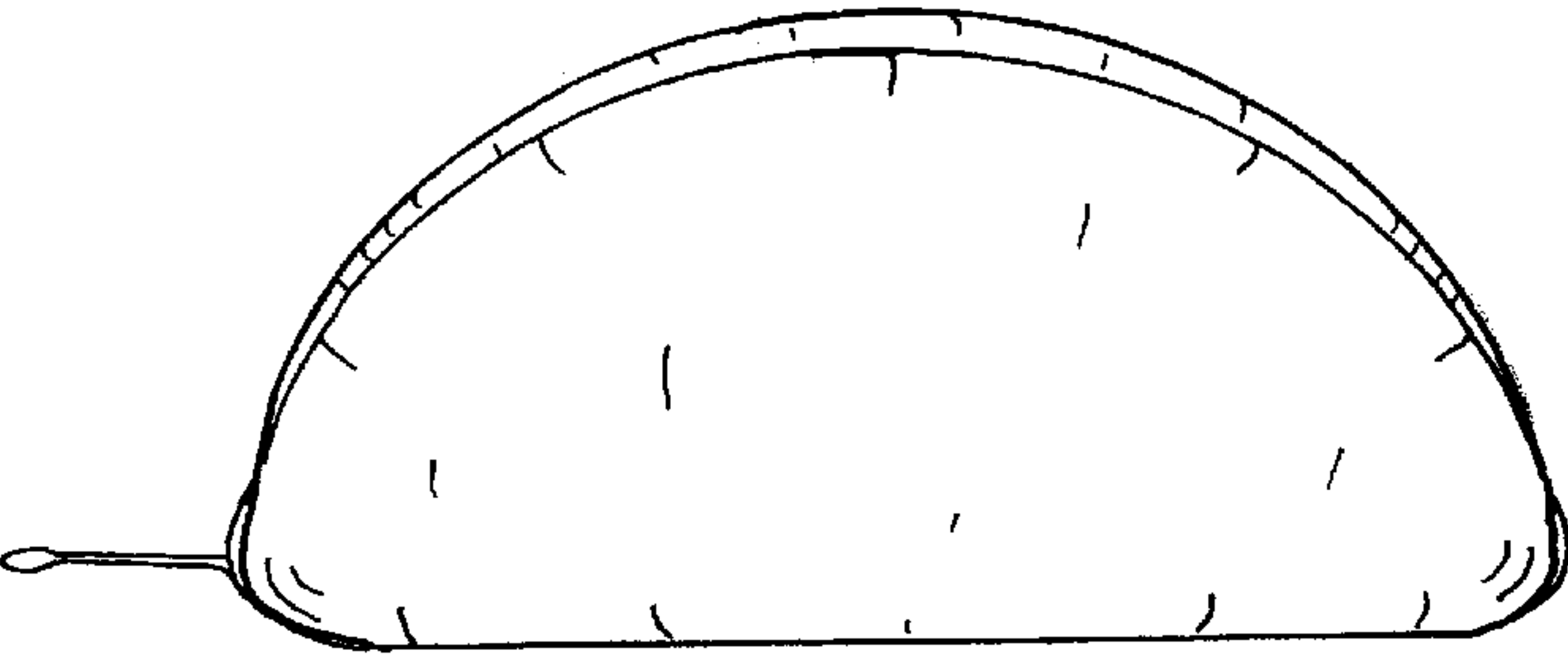

Fig. 2

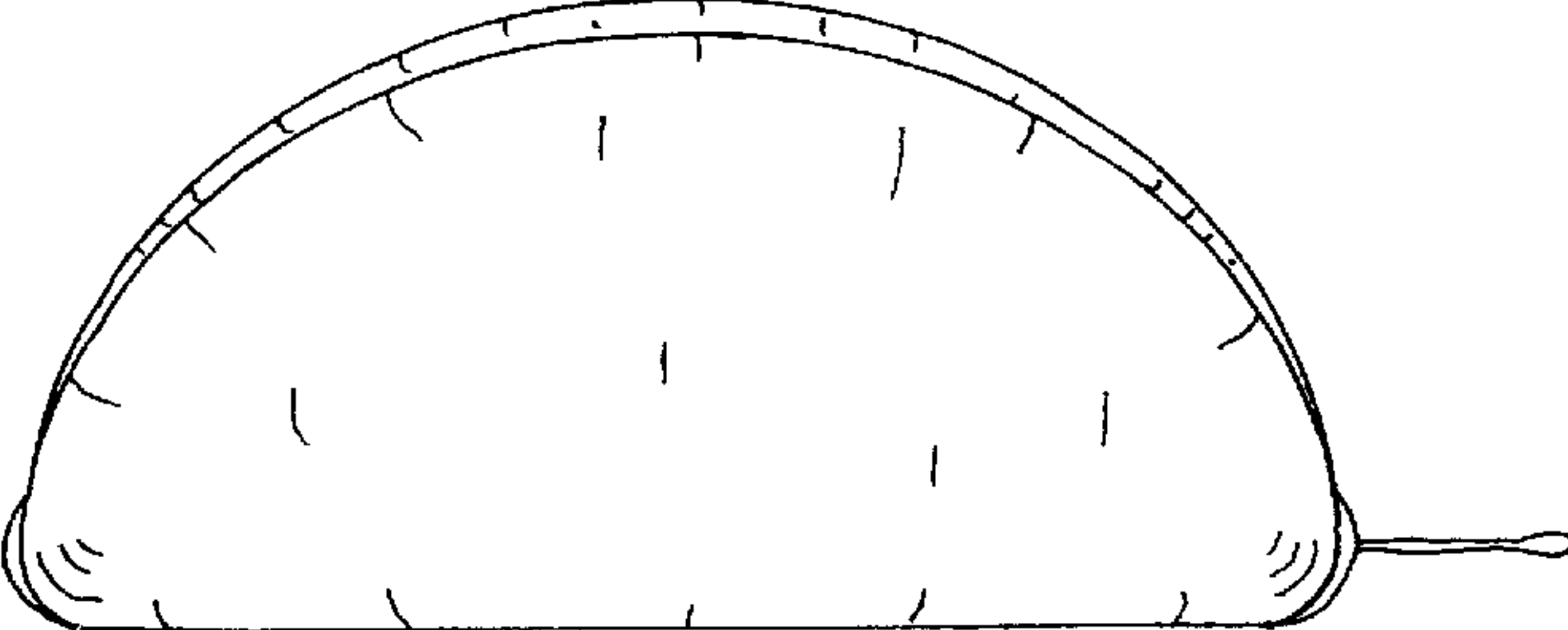

Fig. 3

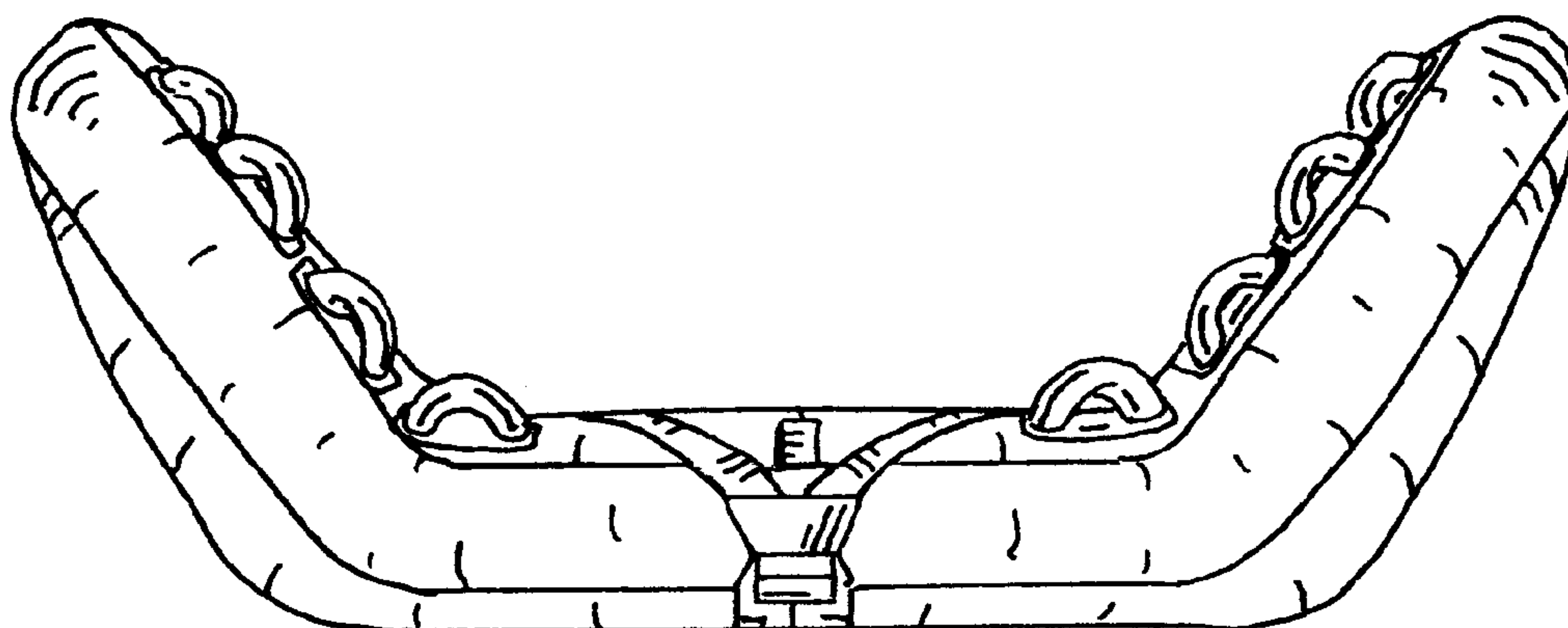

Fig. 4

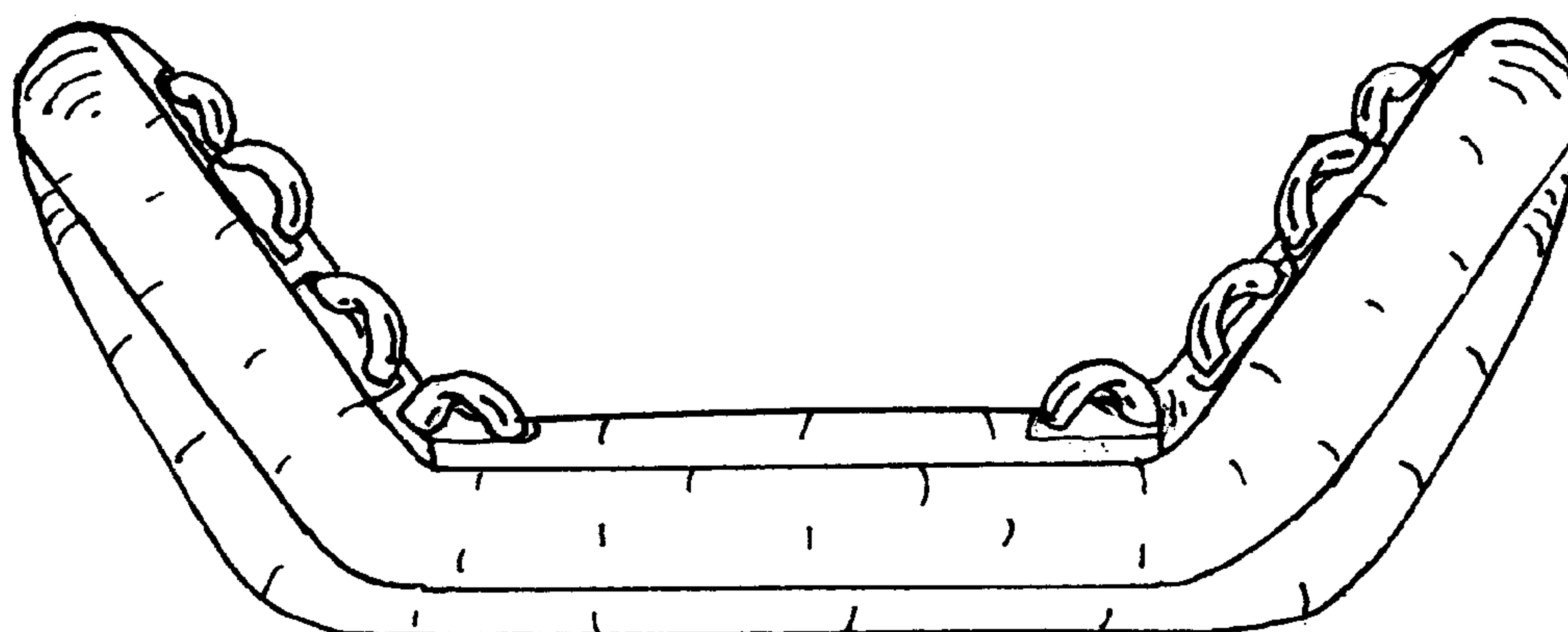

Fig. 5

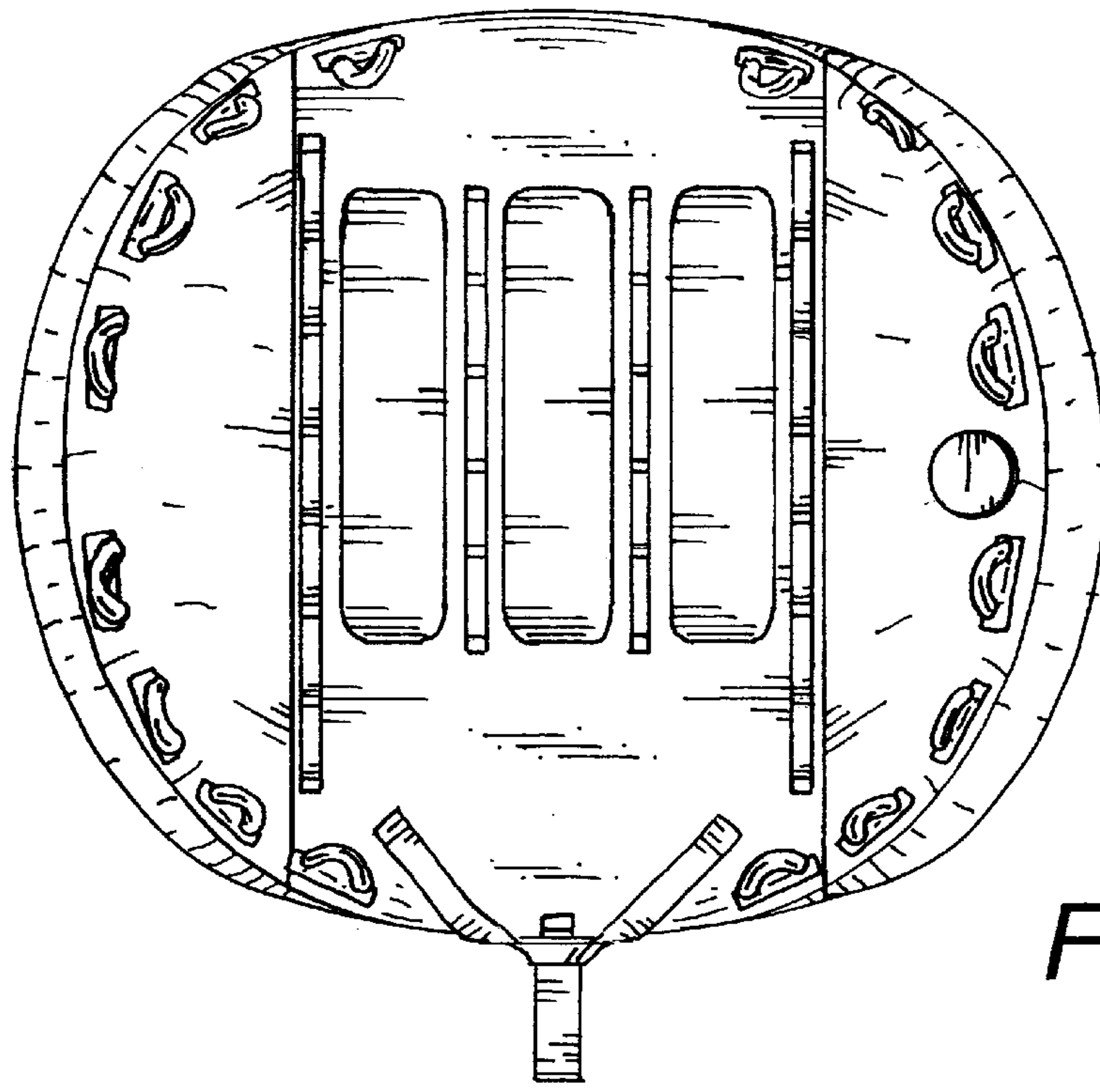

Fig. 6

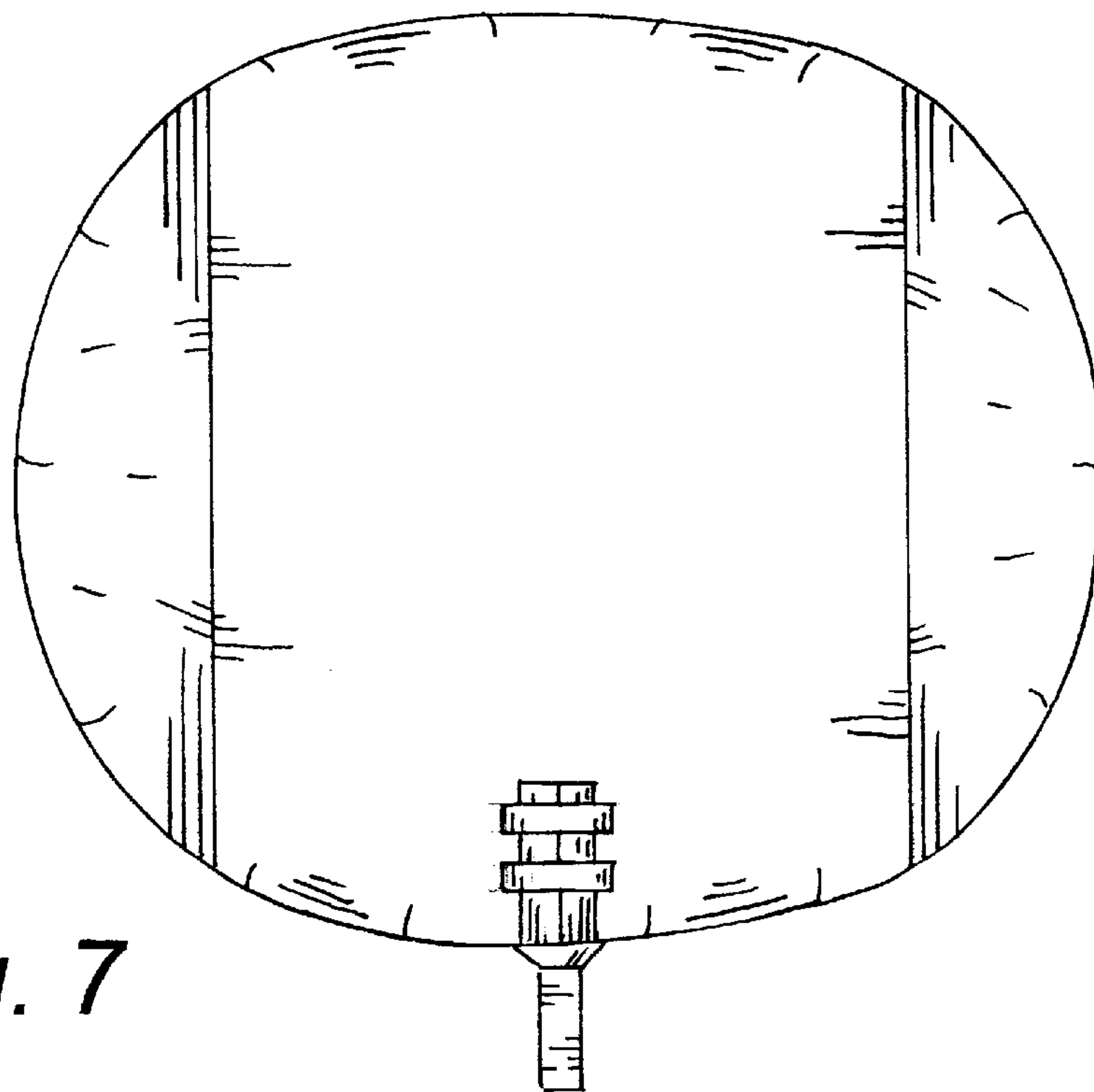

Fig. 7