

US00D505973S

(12) **United States Design Patent**
Jones et al.

(10) **Patent No.: US D505,973 S**
(45) **Date of Patent: ** Jun. 7, 2005**

(54) **INK STICK FOR PHASE CHANGE INK JET PRINTER**

(75) Inventors: **Brent R. Jones**, Tualatin, OR (US);
Frederick T. Mattern, Portland, OR (US); **Jasper Wong**, Portland, OR (US)

(73) Assignee: **Xerox Corporation**, Stamford, CT (US)

(**) Term: **14 Years**

(21) Appl. No.: **29/195,170**

(22) Filed: **Dec. 8, 2003**

(51) **LOC (8) Cl.** **18-02**

(52) **U.S. Cl.** **D18/56; 347/88**

(58) **Field of Search** D18/56; D21/499;
347/88, 99; 106/31.29, 31.61

(56) **References Cited**

U.S. PATENT DOCUMENTS

5,223,860 A	6/1993	Loofbourow et al.	
D346,821 S	5/1994	Smith	D18/56
5,510,821 A	4/1996	Jones et al.	347/88
D371,801 S	* 7/1996	Jones et al.	D18/56
D392,651 S	* 3/1998	Ishii	D18/56
5,734,402 A	3/1998	Rousseau et al.	347/88
D403,352 S	* 12/1998	Brown et al.	D18/56
D403,699 S	1/1999	Chin et al.	D18/56
5,861,903 A	1/1999	Crawford et al.	347/88
D407,742 S	* 4/1999	Yao et al.	D18/56
D416,936 S	* 11/1999	Chin et al.	D18/56
D478,347 S	8/2003	Jones	D18/56
D479,368 S	9/2003	Jones	
D481,758 S	11/2003	Jones	D18/56
D482,062 S	11/2003	Jones	D18/56
D482,389 S	* 11/2003	Jones	D18/56

D482,721 S	* 11/2003	Jones	D18/56
D482,722 S	* 11/2003	Jones	D18/56
6,672,716 B2	* 1/2004	Jones	347/88
D494,620 S	* 8/2004	Levin et al.	D18/56
2003/0202071 A1	10/2003	Jones et al.	347/88
2003/0202075 A1	10/2003	Jones	347/99

OTHER PUBLICATIONS

A list of Tektronix/Xerox Corporation Solid Ink Products sold at least one year prior to Apr. 29, 2002.

* cited by examiner

Primary Examiner—Cathy Anne McCormac

(57) **CLAIM**

The ornamental design for an ink stick for phase change ink jet printer, as shown and described.

DESCRIPTION

FIG. 1 is a perspective view of an ink stick for phase change ink jet printer illustrating a first embodiment of the new design;

FIG. 2 is a front elevational view thereof;

FIG. 3 is a right side elevational view thereof;

FIG. 4 is a rear elevational view thereof;

FIG. 5 is a left side elevational view thereof;

FIG. 6 is a top plan view thereof;

FIG. 7 is a bottom plan view thereof;

FIG. 8 is a perspective view of FIG. 1;

FIG. 9 is a front elevational view of FIG. 8;

FIG. 10 is a right side elevational view of FIG. 8;

FIG. 11 is a rear elevational view of FIG. 8;

FIG. 12 is a left side elevational view of FIG. 8;

FIG. 13 is a top plan view of FIG. 8; and,

FIG. 14 is a bottom plan view of FIG. 8.

1 Claim, 8 Drawing Sheets

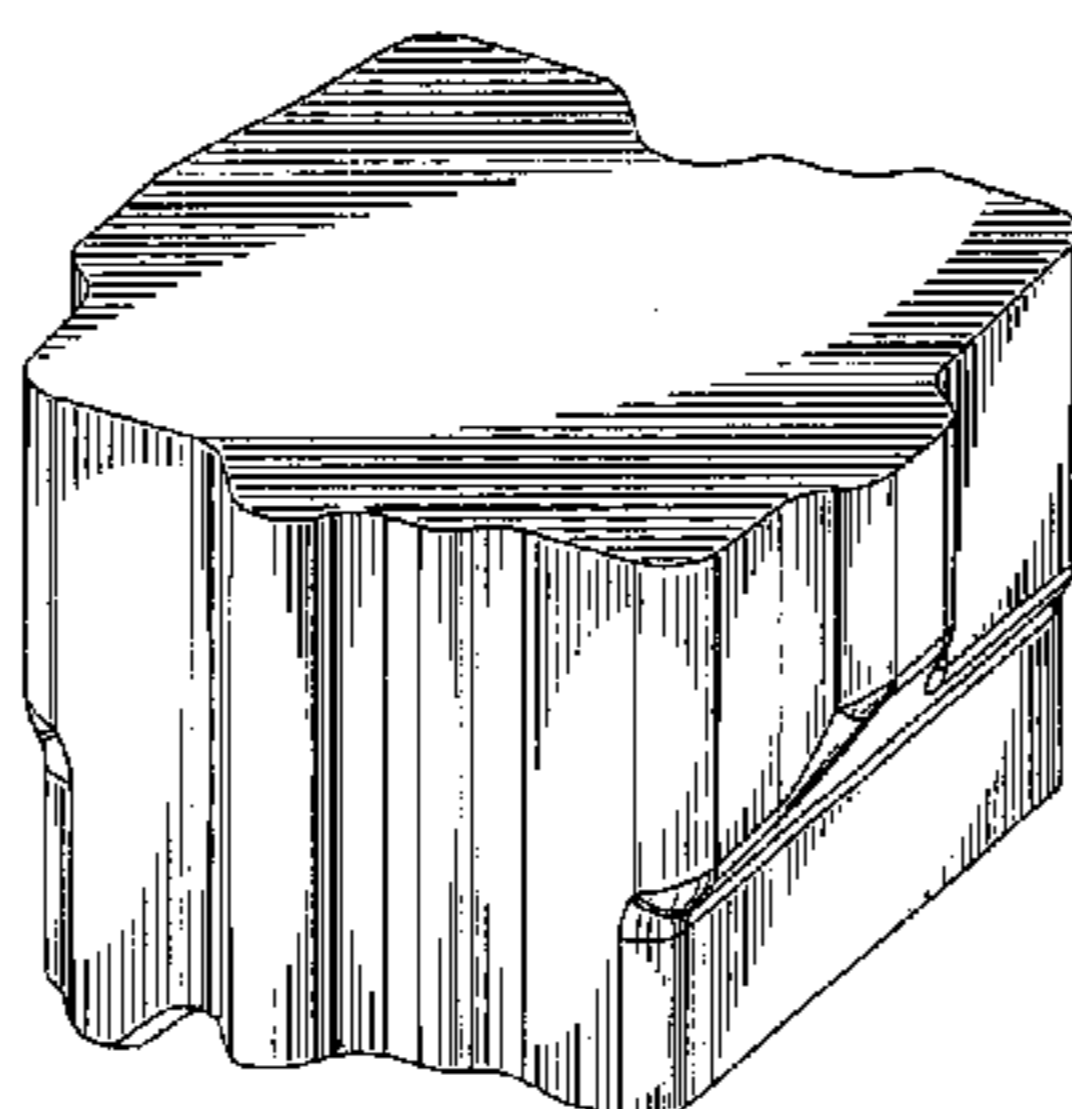
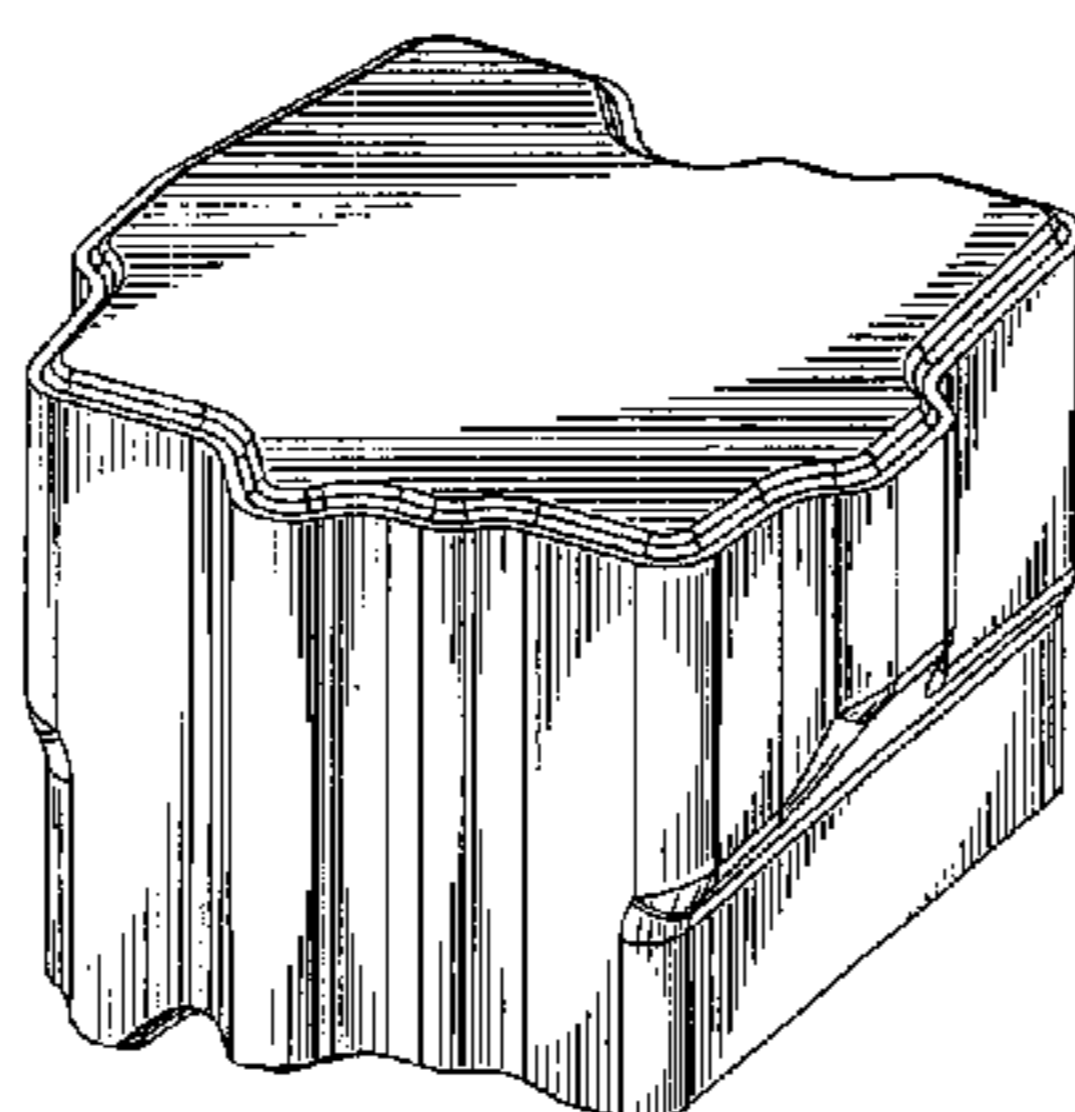

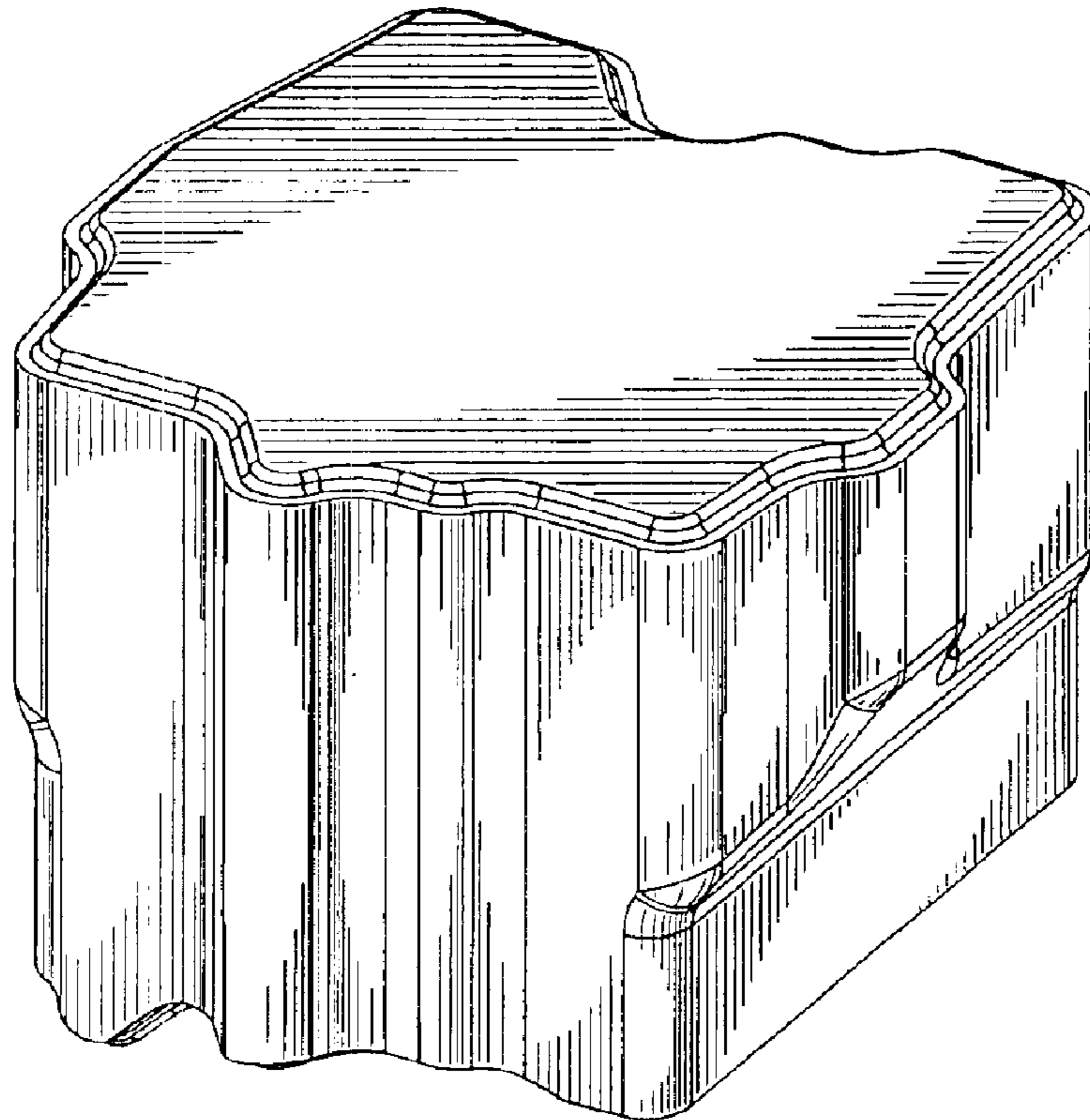

FIG. 1

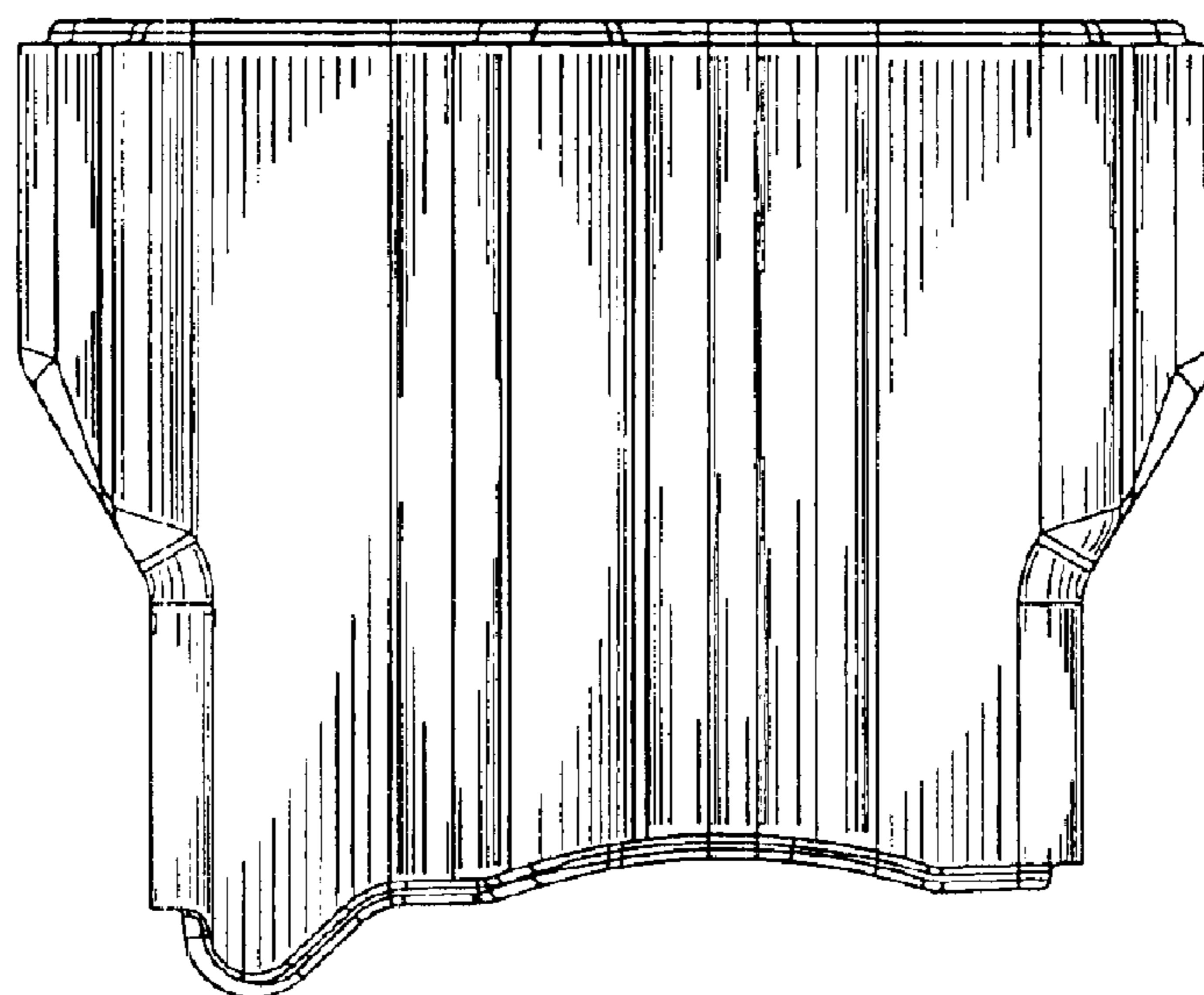

FIG. 2

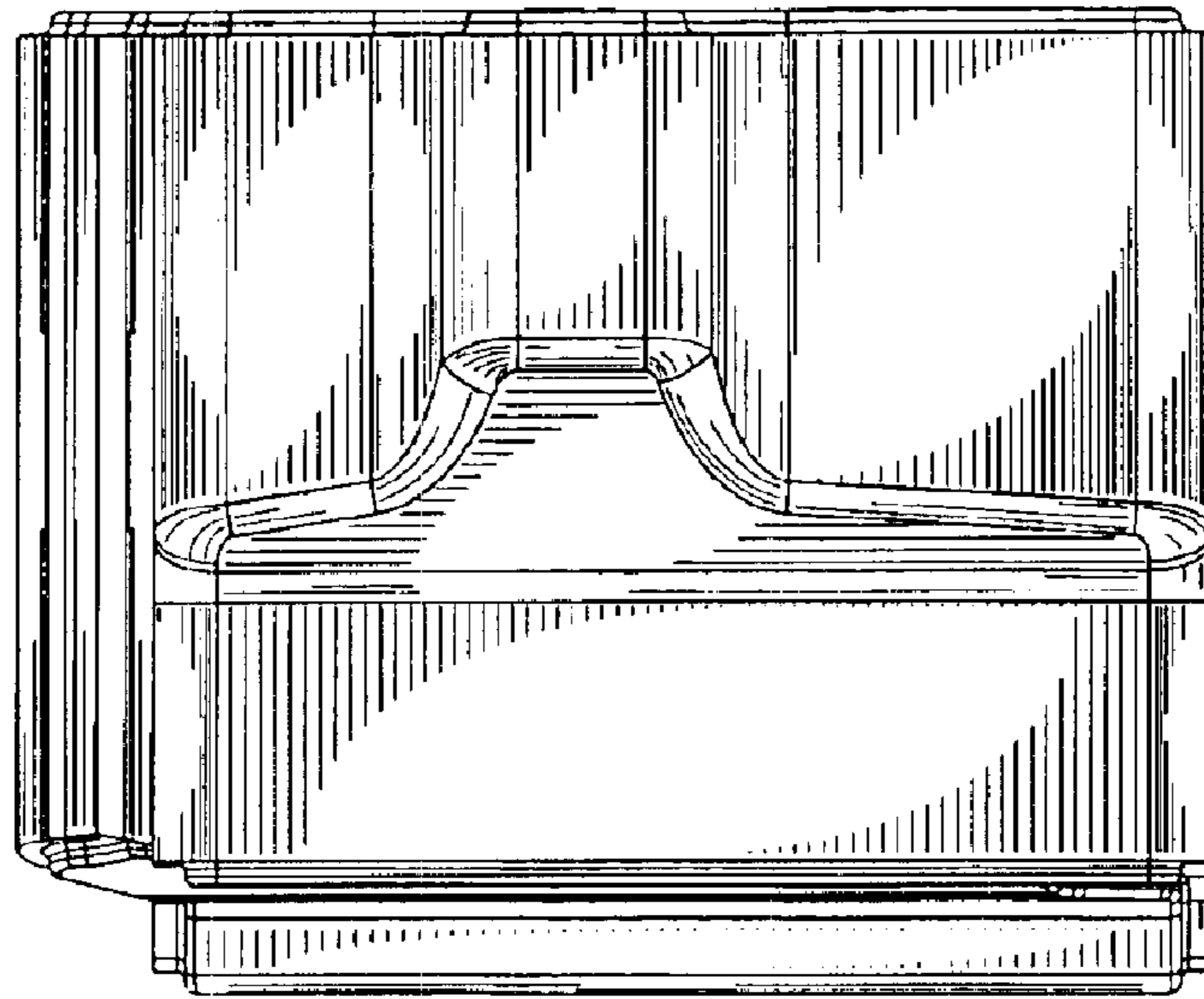

FIG. 3

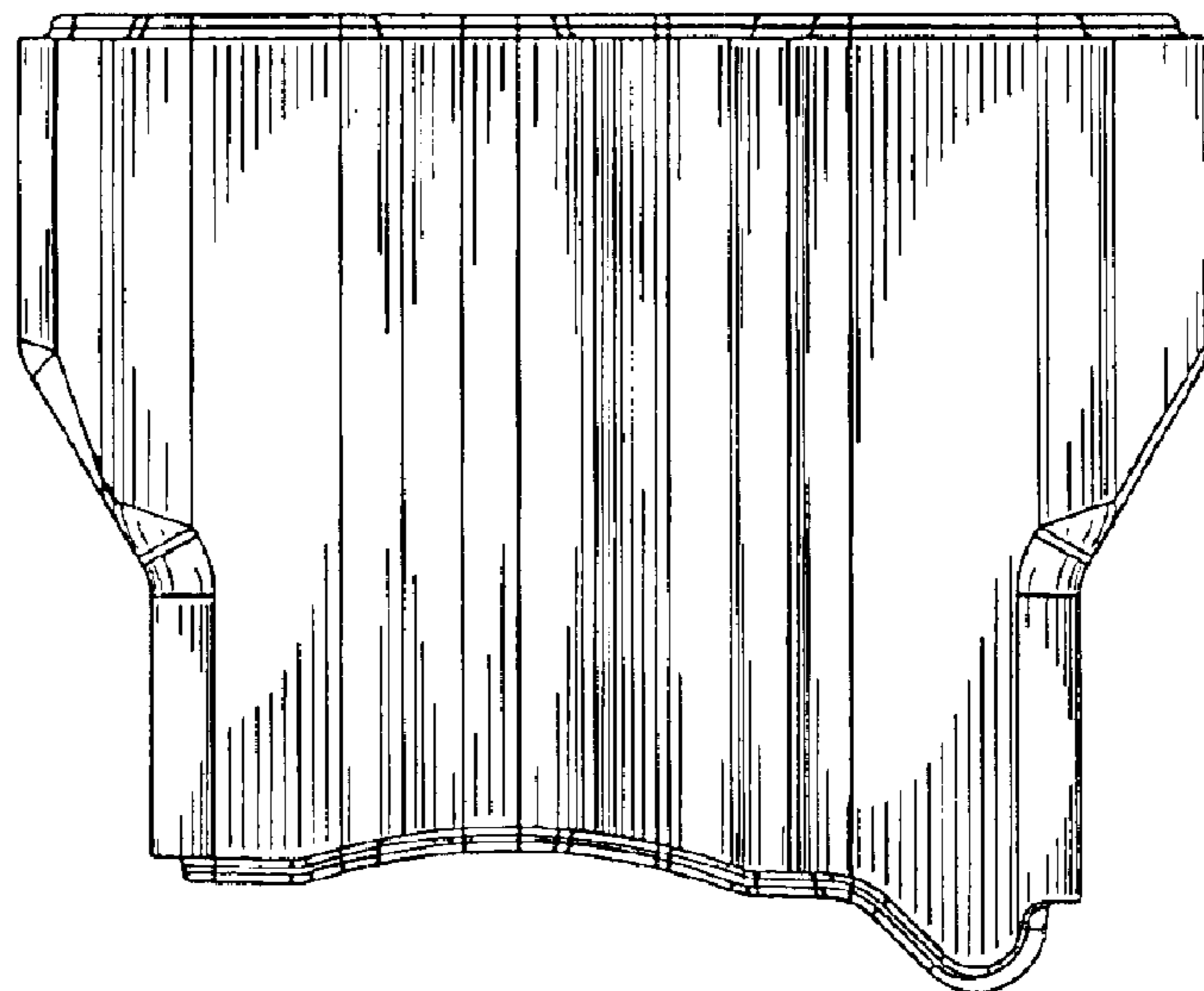

FIG. 4

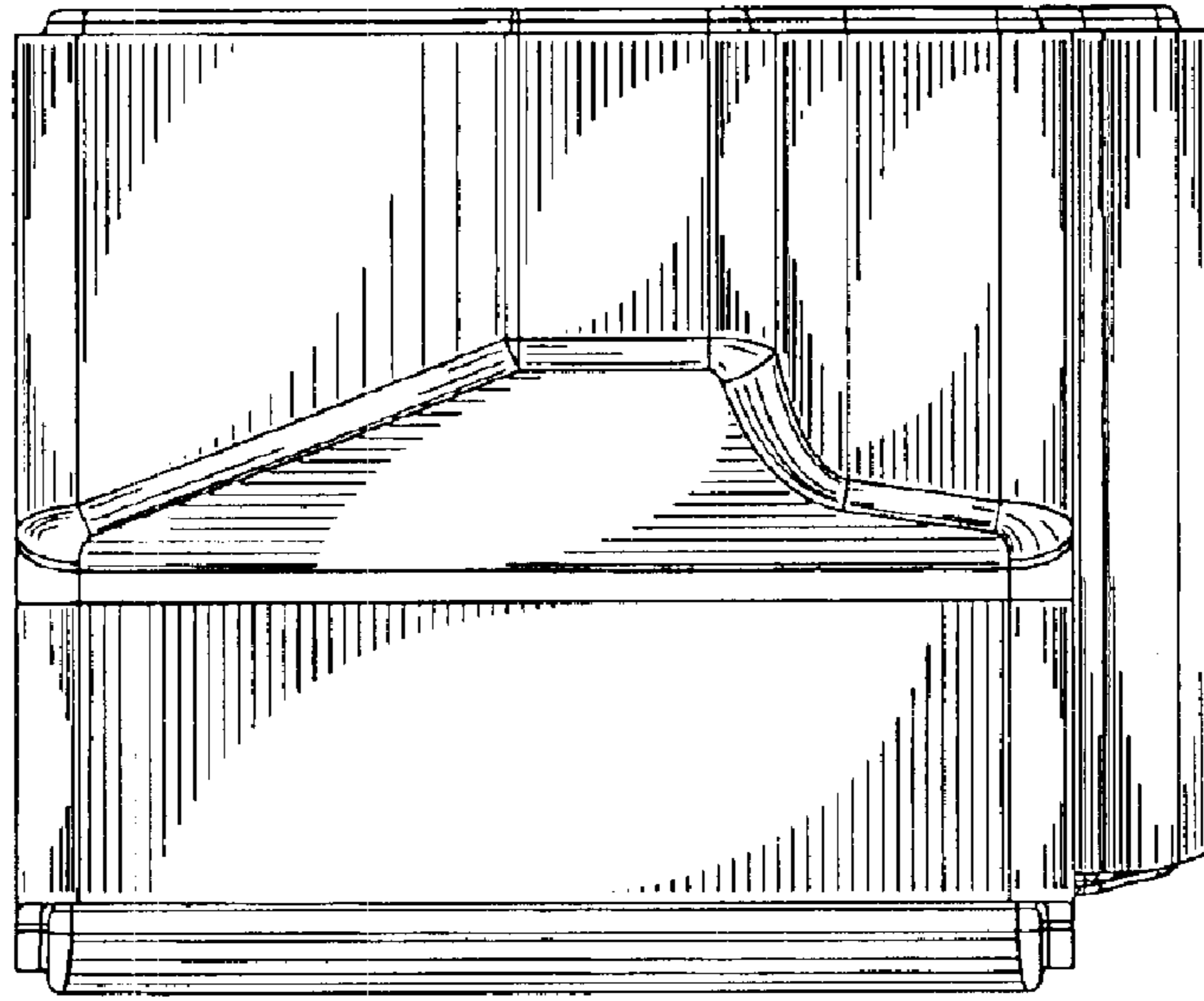

FIG. 5

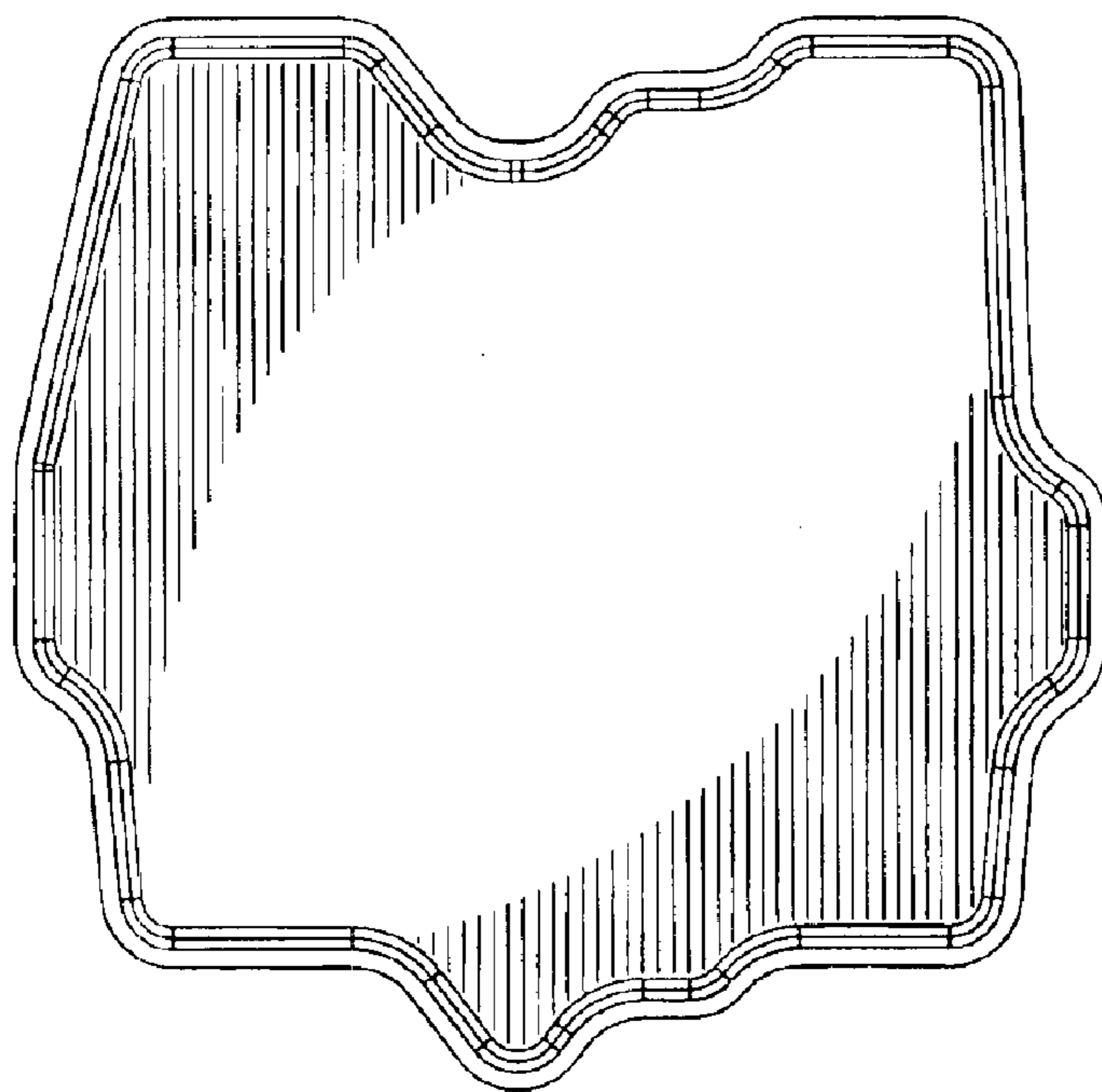

FIG. 6

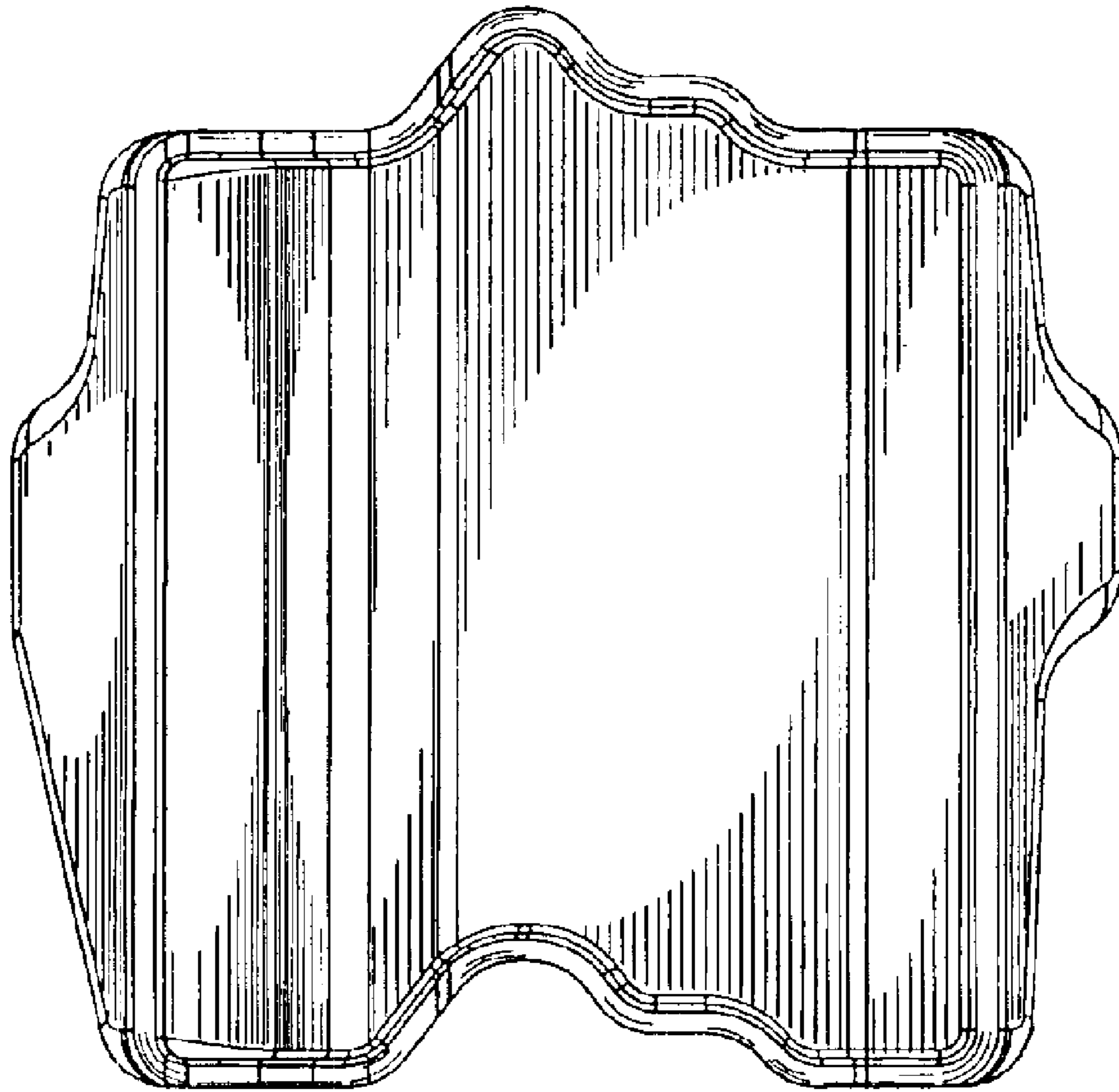

FIG. 7

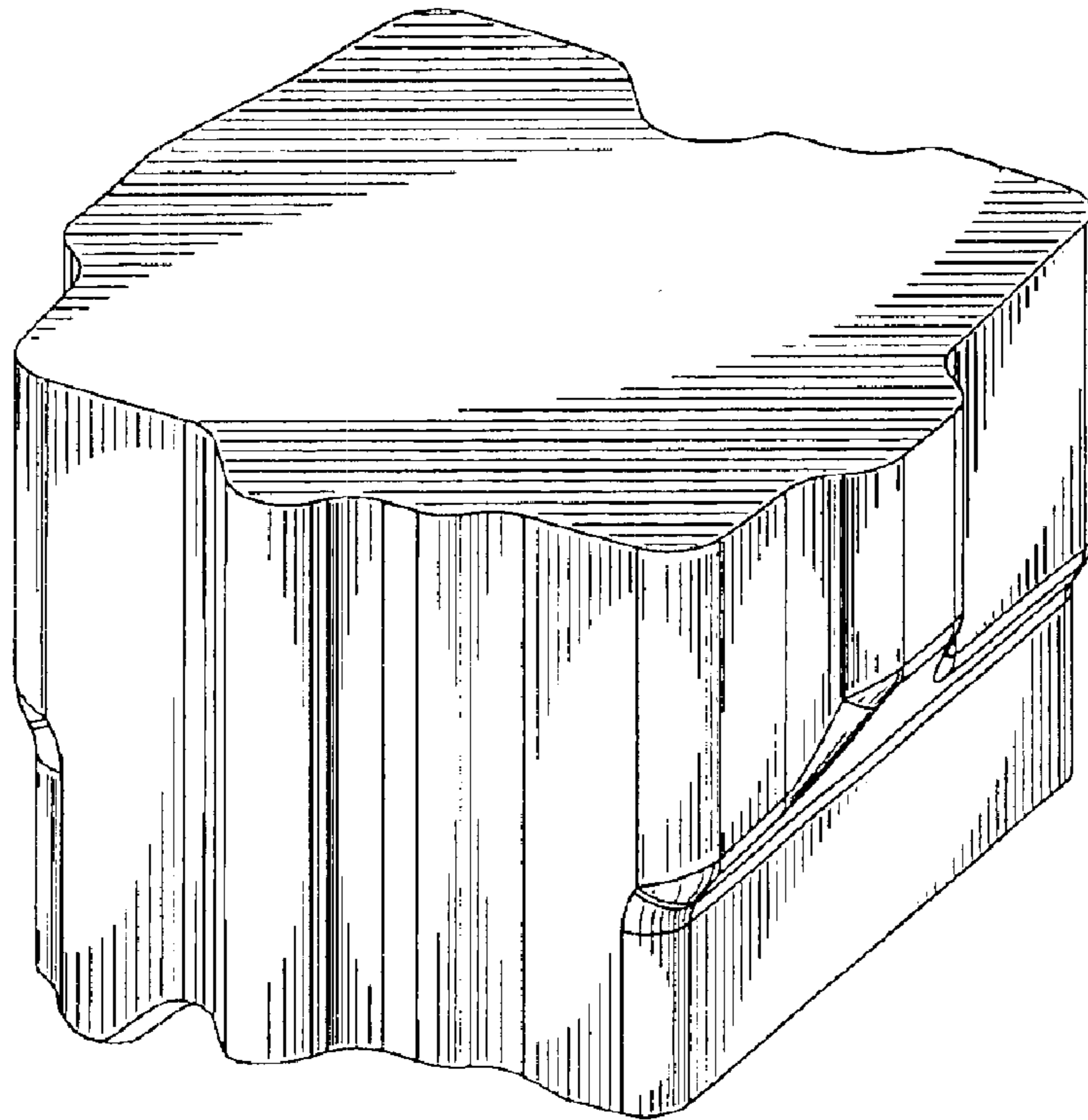

FIG. 8

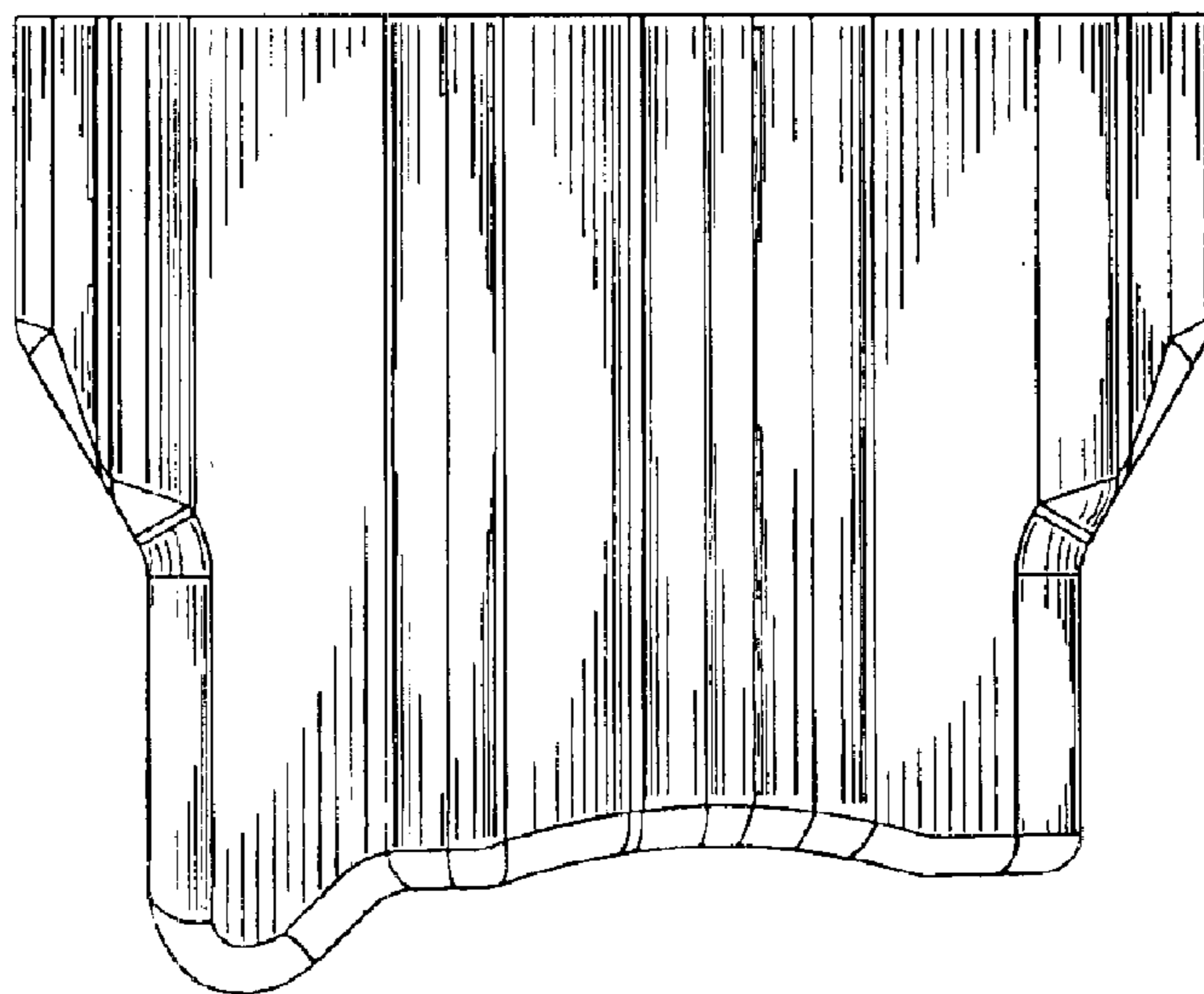

FIG. 9

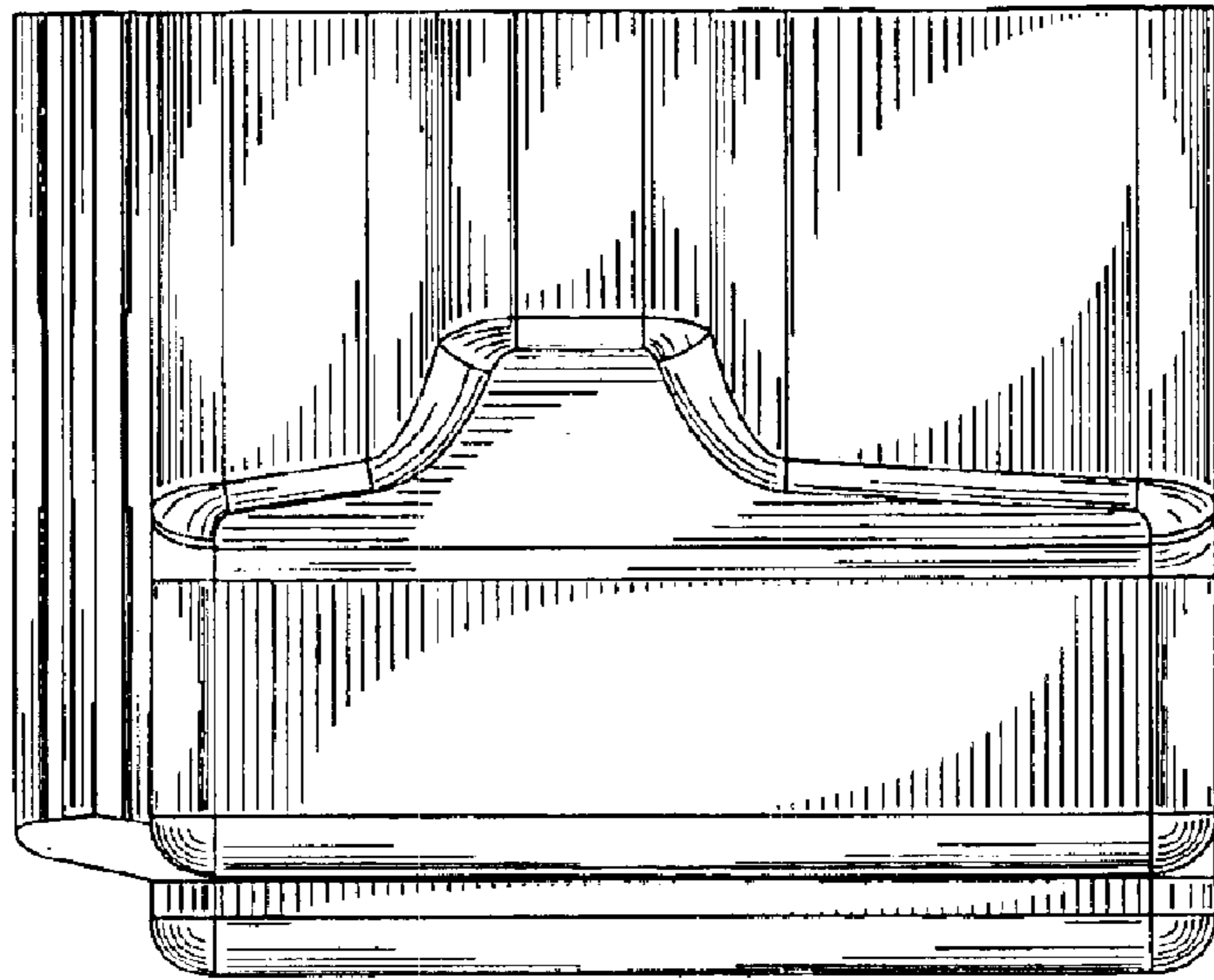

FIG. 10

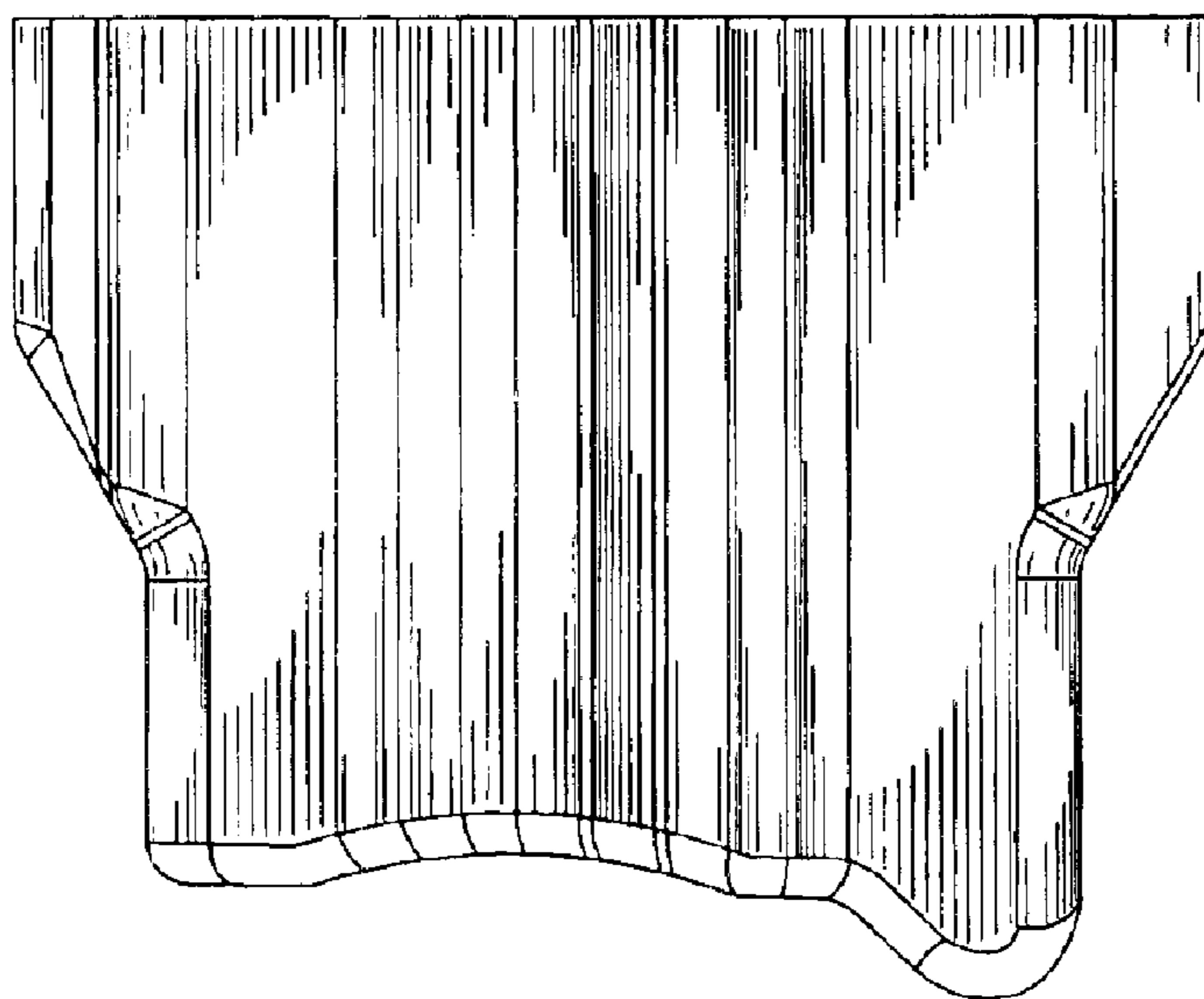

FIG. 11

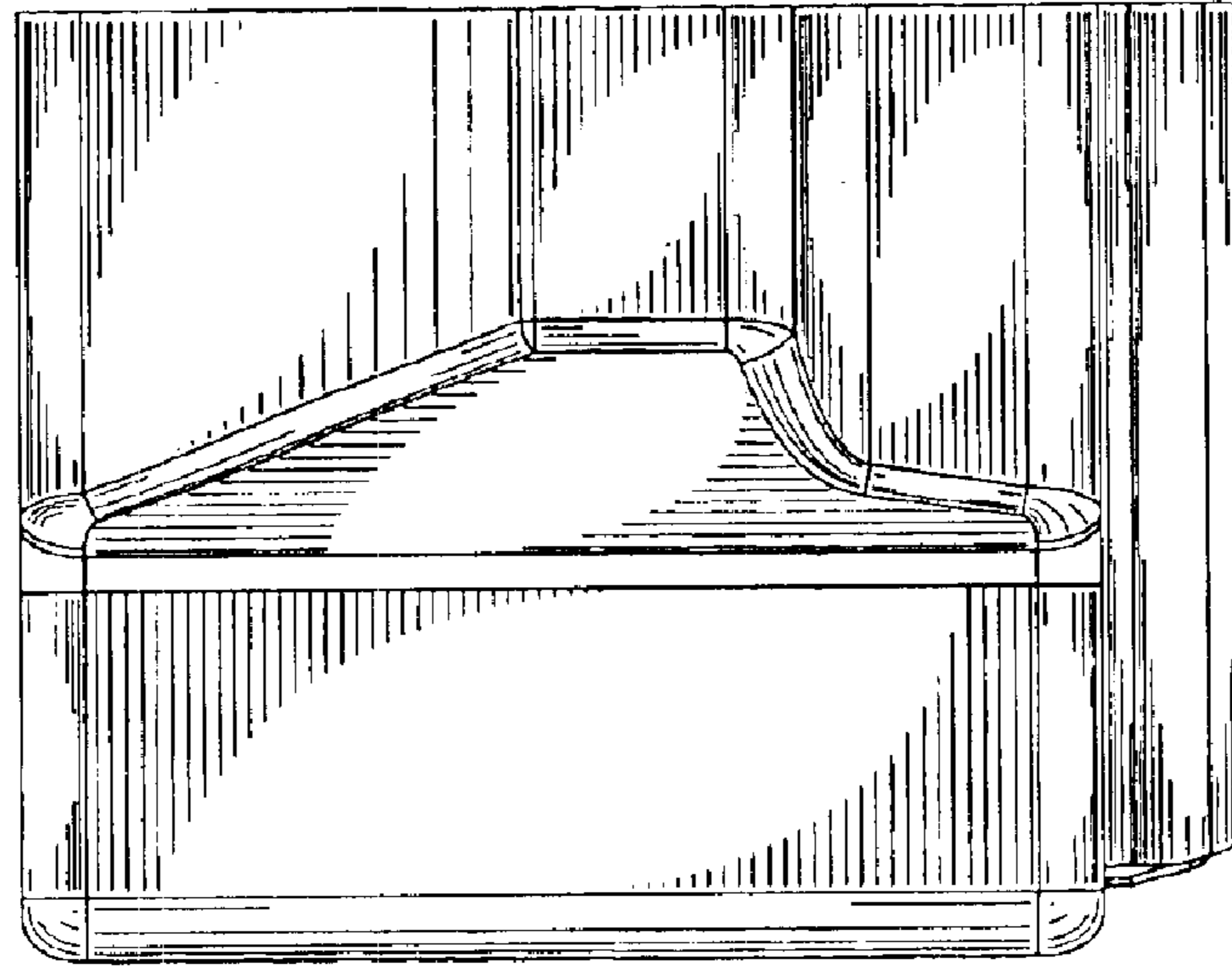

FIG. 12

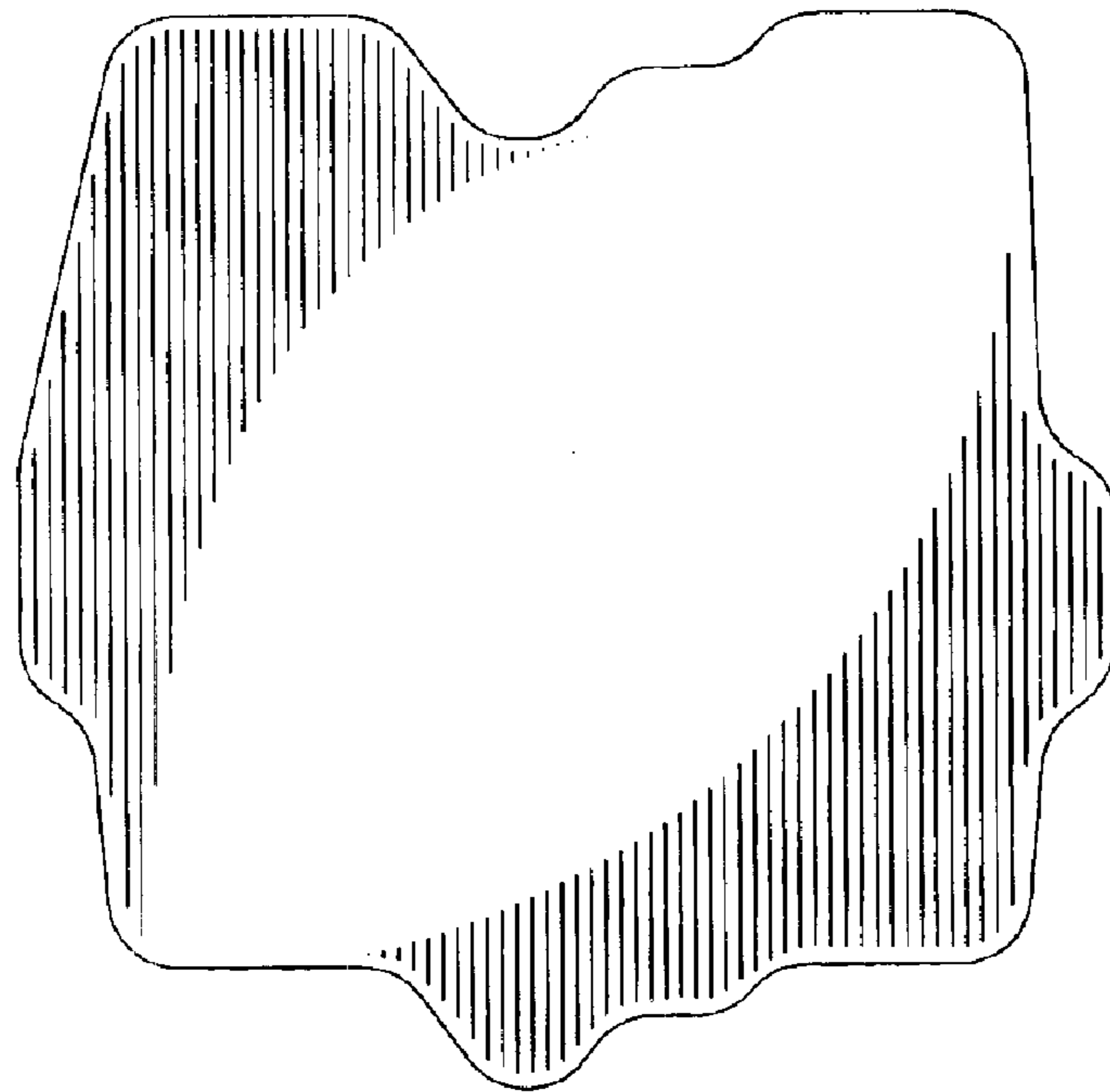

FIG. 13

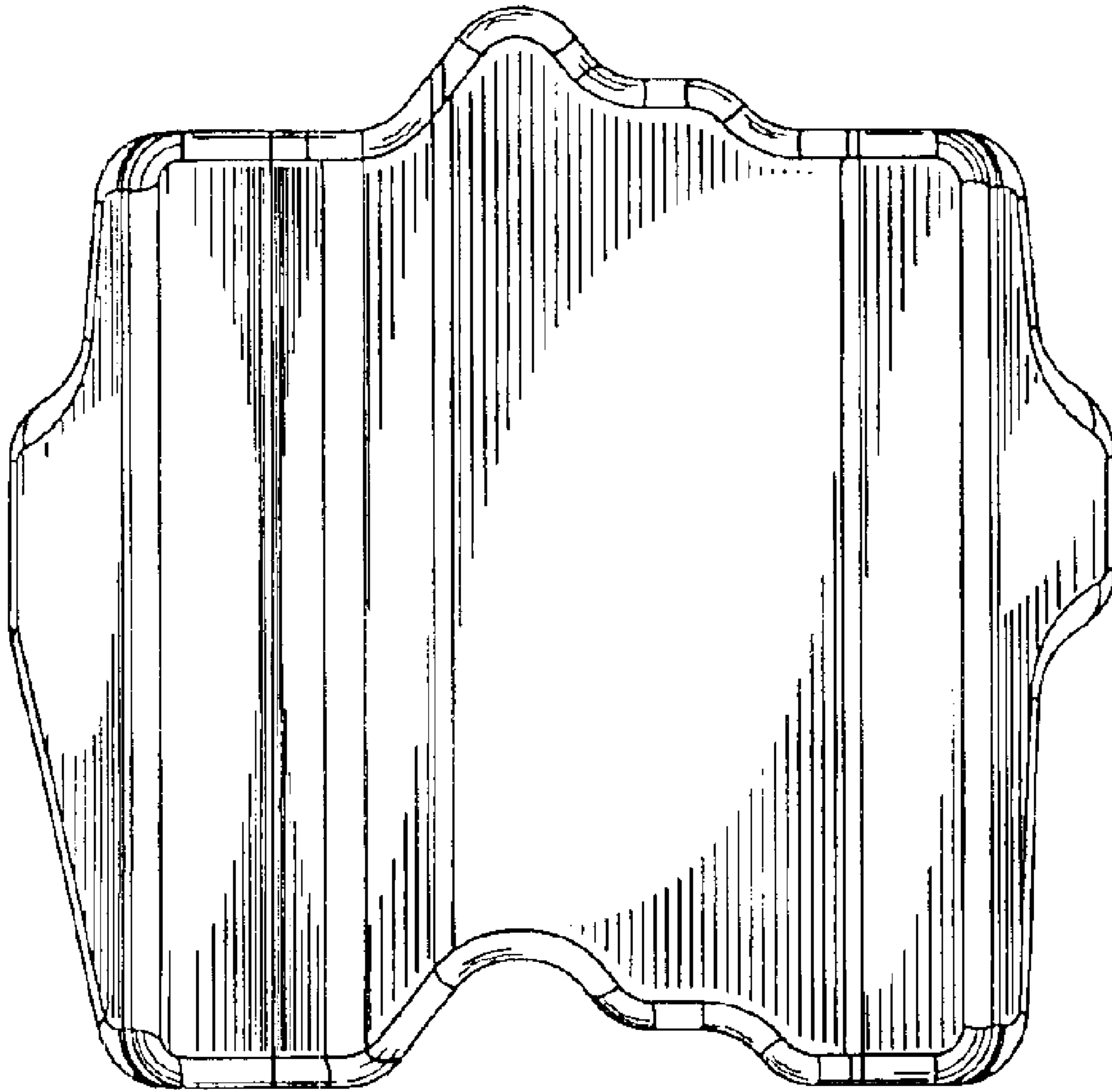

FIG. 14