

US00D505871S

(12) **United States Design Patent** (10) **Patent No.:** **US D505,871 S**
Little et al. (45) **Date of Patent:** **** Jun. 7, 2005**

(54) **PRESSURE GAUGE**

(75) Inventors: **Baird M. Little**, Nashua, NH (US);
Kenneth David Harris, Jr., Nashua,
 NH (US); **Joseph Geringer**,
 Merrimack, NH (US); **Charles J.**
Burout, III, Bedford, NH (US); **Steven**
H. Schwartz, Bedford, NH (US)

(73) Assignee: **Brookstone Purchasing, Inc.**,
 Merrimack, NH (US)

(**) Term: **14 Years**

(21) Appl. No.: **29/196,868**

(22) Filed: **Jan. 6, 2004**

(51) **LOC (8) Cl.** **10-04**

(52) **U.S. Cl.** **D10/85; D10/86**

(58) **Field of Search** **D10/86, 85; 73/744,**
73/146.3, 146.8; 116/34 R, 272; 702/140

(56) **References Cited**

U.S. PATENT DOCUMENTS

| | | | |
|-------------|----------|----------------|--------------|
| 4,333,491 A | 6/1982 | Knubley | |
| 4,384,543 A | 5/1983 | Wong | |
| 4,748,845 A | 6/1988 | Rocco et al. | |
| 4,924,697 A | 5/1990 | Hunt et al. | |
| 4,998,438 A | 3/1991 | Martin | |
| 5,168,751 A | 12/1992 | Hwang | |
| D349,659 S | * 8/1994 | Huang | D10/86 |
| 5,394,343 A | 2/1995 | Tsao | |
| 5,556,489 A | 9/1996 | Curlett et al. | |
| 5,606,123 A | 2/1997 | Rabizadeh | |

| | | | |
|-----------------|----------|------------------|----------------|
| 5,628,350 A | 5/1997 | Gibb | |
| 5,644,074 A | * 7/1997 | Huang | 73/146.8 |
| D390,140 S | * 2/1998 | Germanton | D10/86 |
| 5,857,481 A | 1/1999 | Zimmerman et al. | |
| 5,875,413 A | 2/1999 | Vinci | |
| 5,891,277 A | 4/1999 | Bachluber | |
| D427,093 S | * 6/2000 | Wu | D10/86 |
| D447,970 S | * 9/2001 | Cappiello et al. | D10/86 |
| D455,361 S | * 4/2002 | Super et al. | D10/86 |
| 6,516,659 B2 | 2/2003 | Chen | |
| 6,530,281 B2 | * 3/2003 | Chou | 73/733 |
| D488,082 S | * 4/2004 | Durr et al. | D10/86 |
| 2003/0024463 A1 | 2/2003 | Evans et al. | |

* cited by examiner

Primary Examiner—Lucy Lieberman

(74) *Attorney, Agent, or Firm*—Nixon Peabody LLP;
Gunnar Leinberg

(57) **CLAIM**

I claim the ornamental design for a pressure gauge, as shown and described.

DESCRIPTION

FIG. 1 is a top and left side perspective view of a pressure gauge showing our new design;
 FIG. 2 is a bottom and right side perspective view thereof;
 FIG. 3. is a top plan view thereof;
 FIG. 4. is a bottom plan view thereof;
 FIG. 5 is a left side elevation thereof;
 FIG. 6 is a right side elevation thereof;
 FIG. 7 is a front elevational view thereof; and,
 FIG. 8 is a rear elevation view of the pressure gauge.

1 Claim, 8 Drawing Sheets

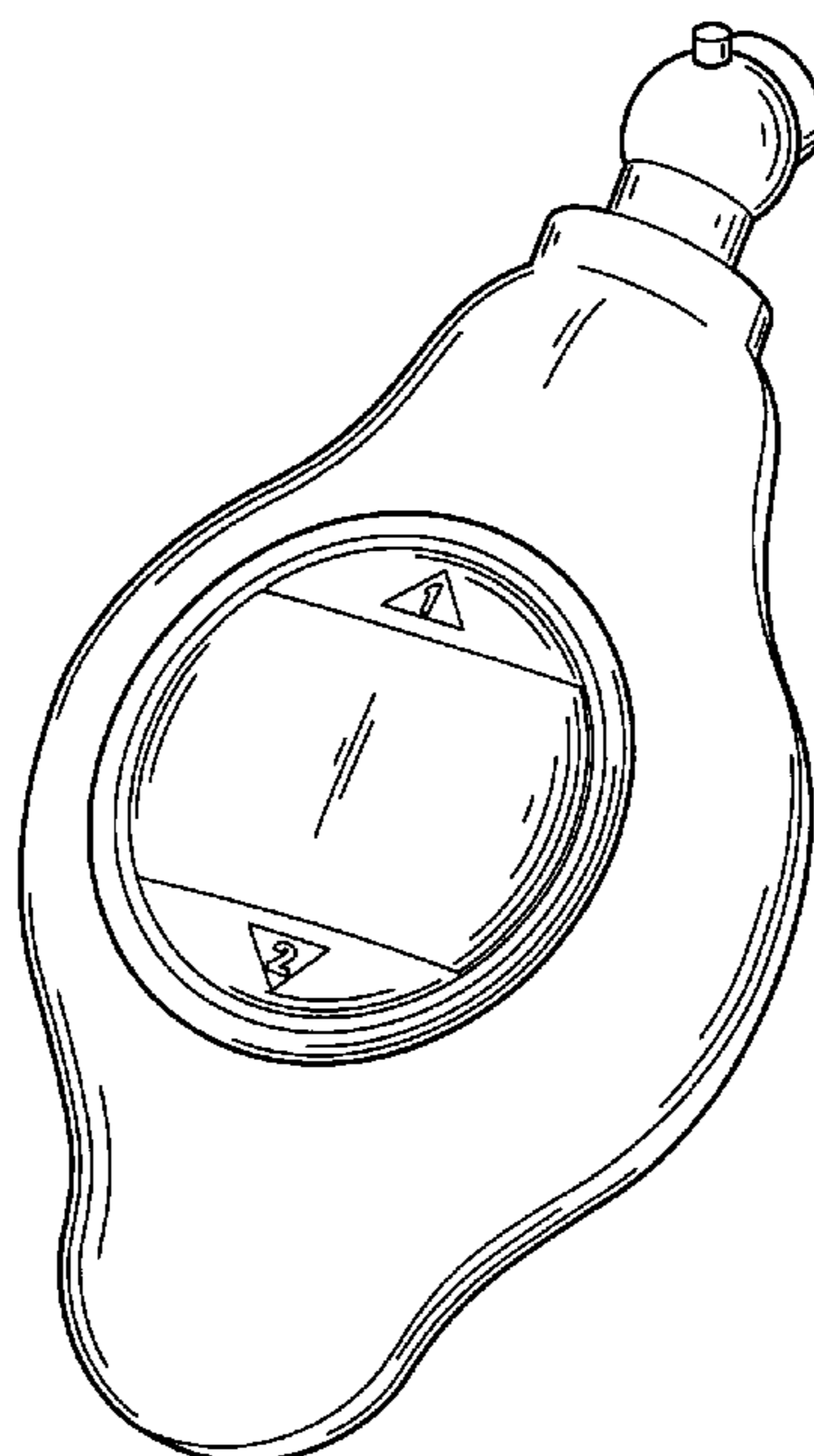

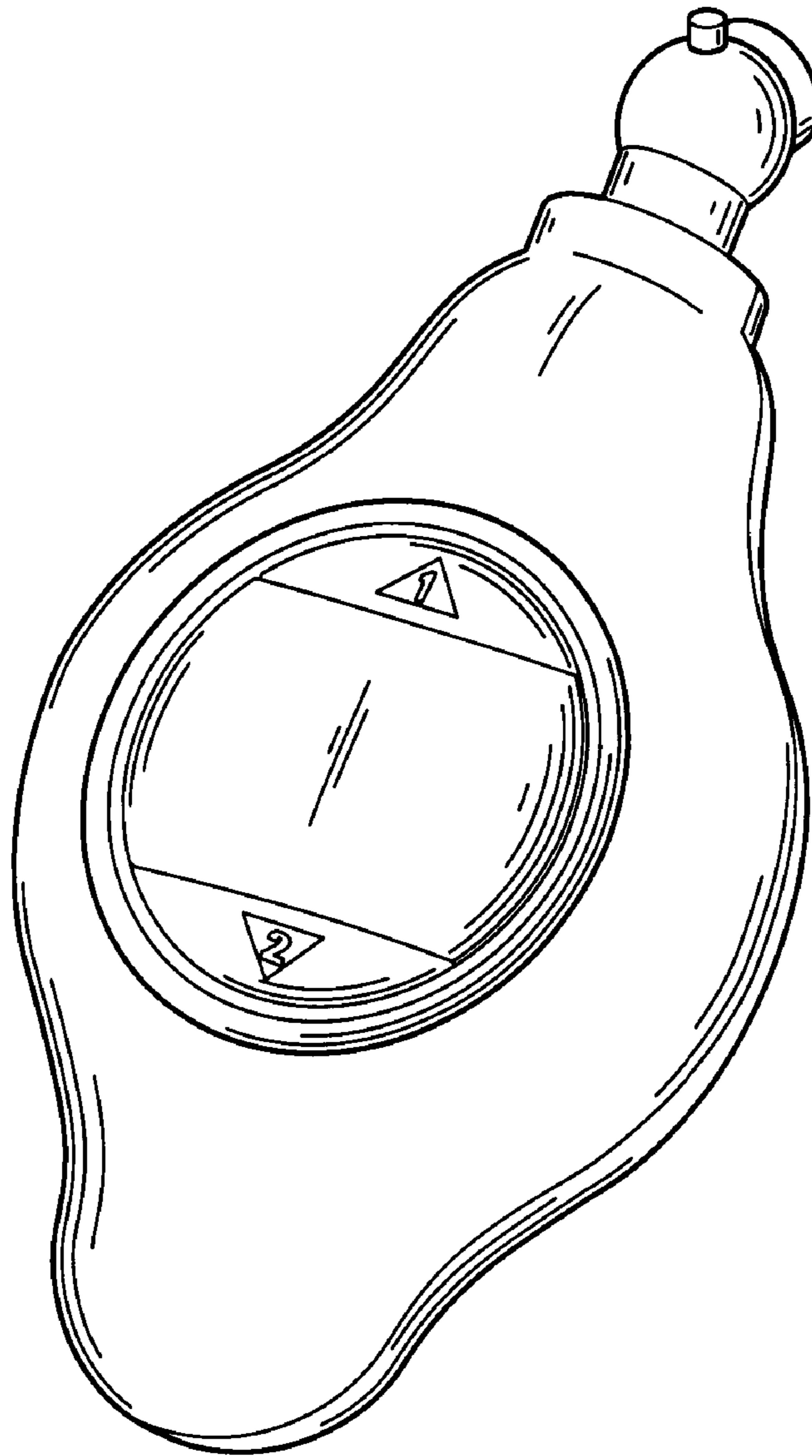

FIG. 1

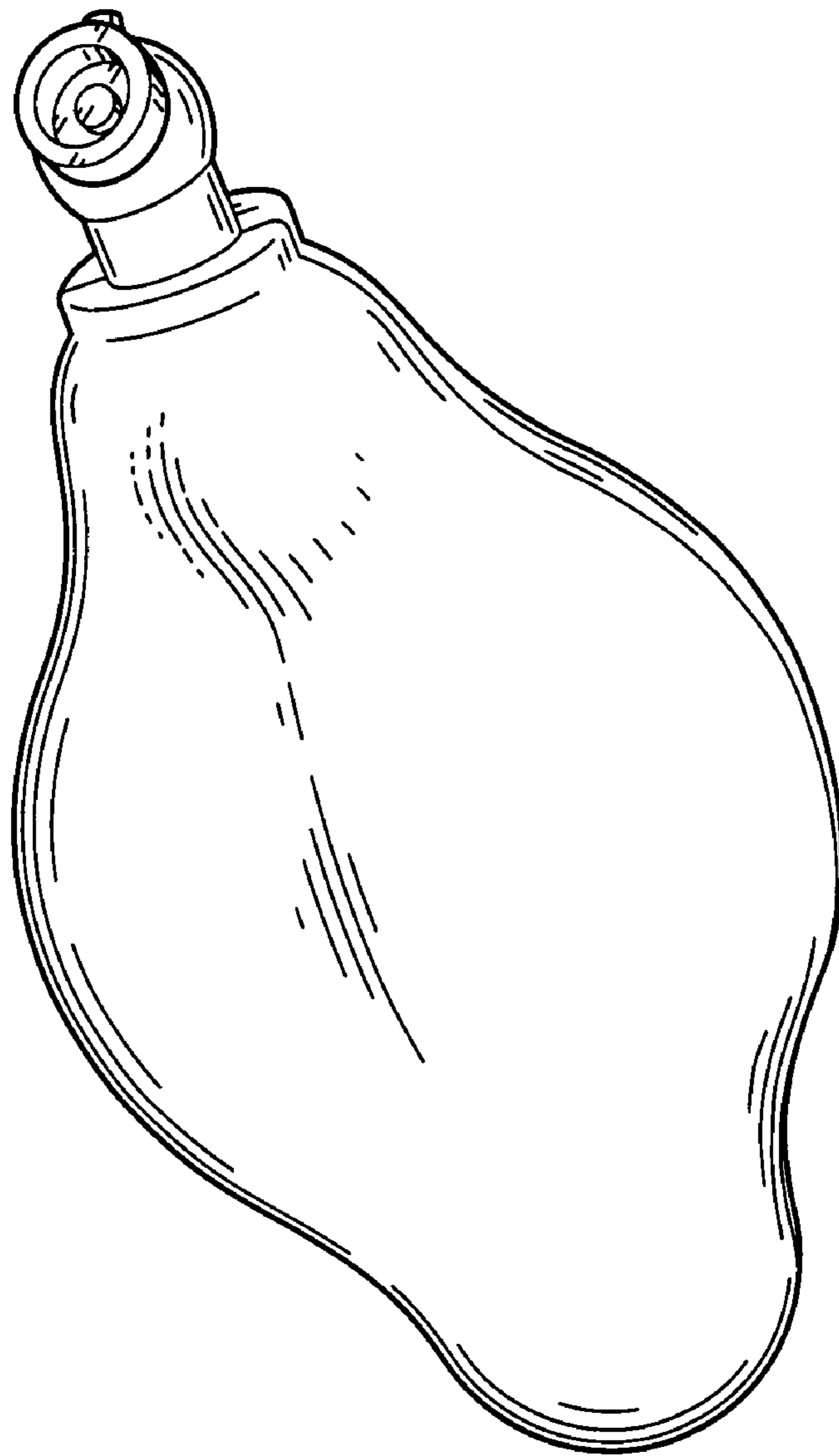

FIG. 2

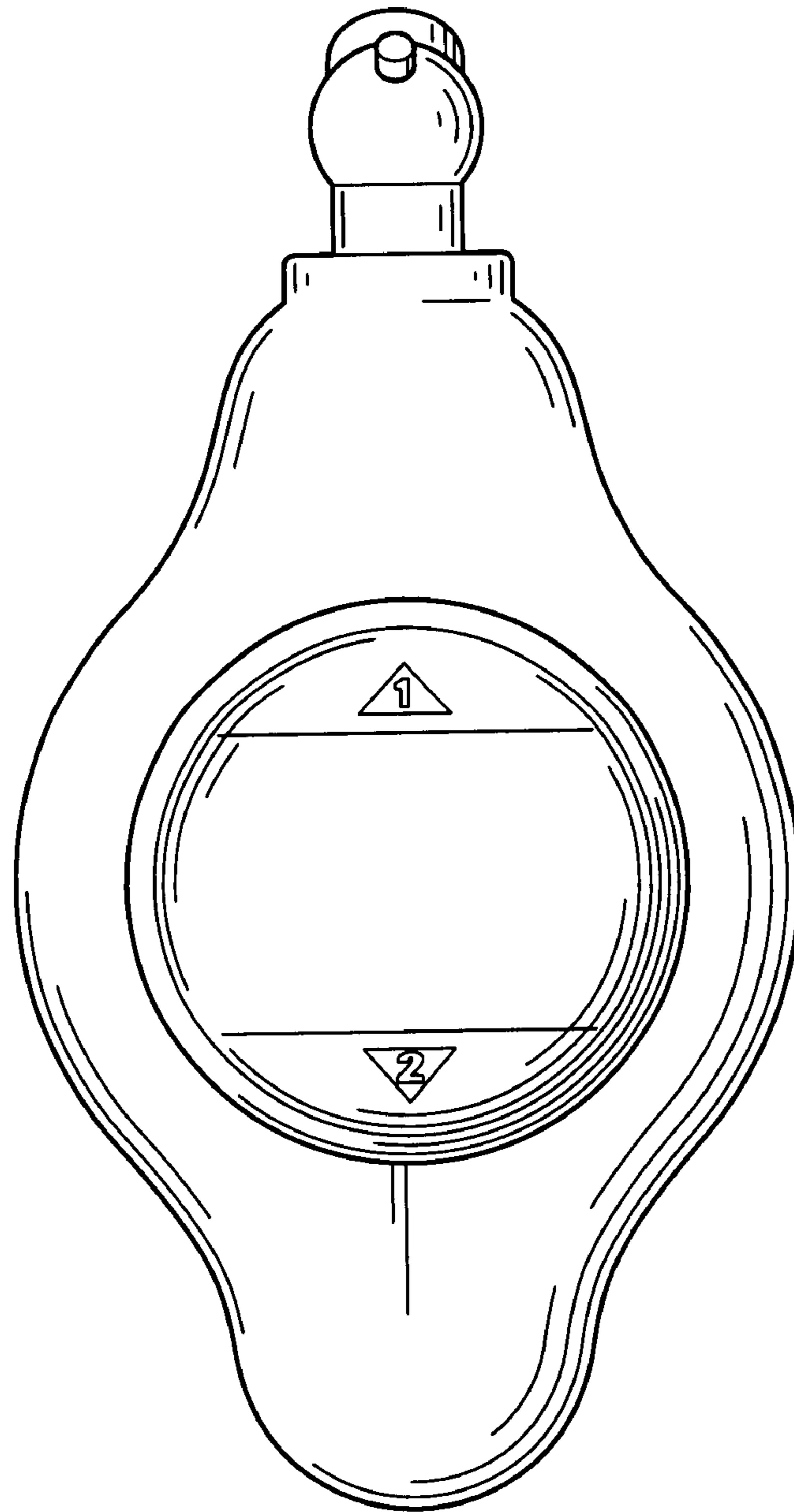

FIG. 3

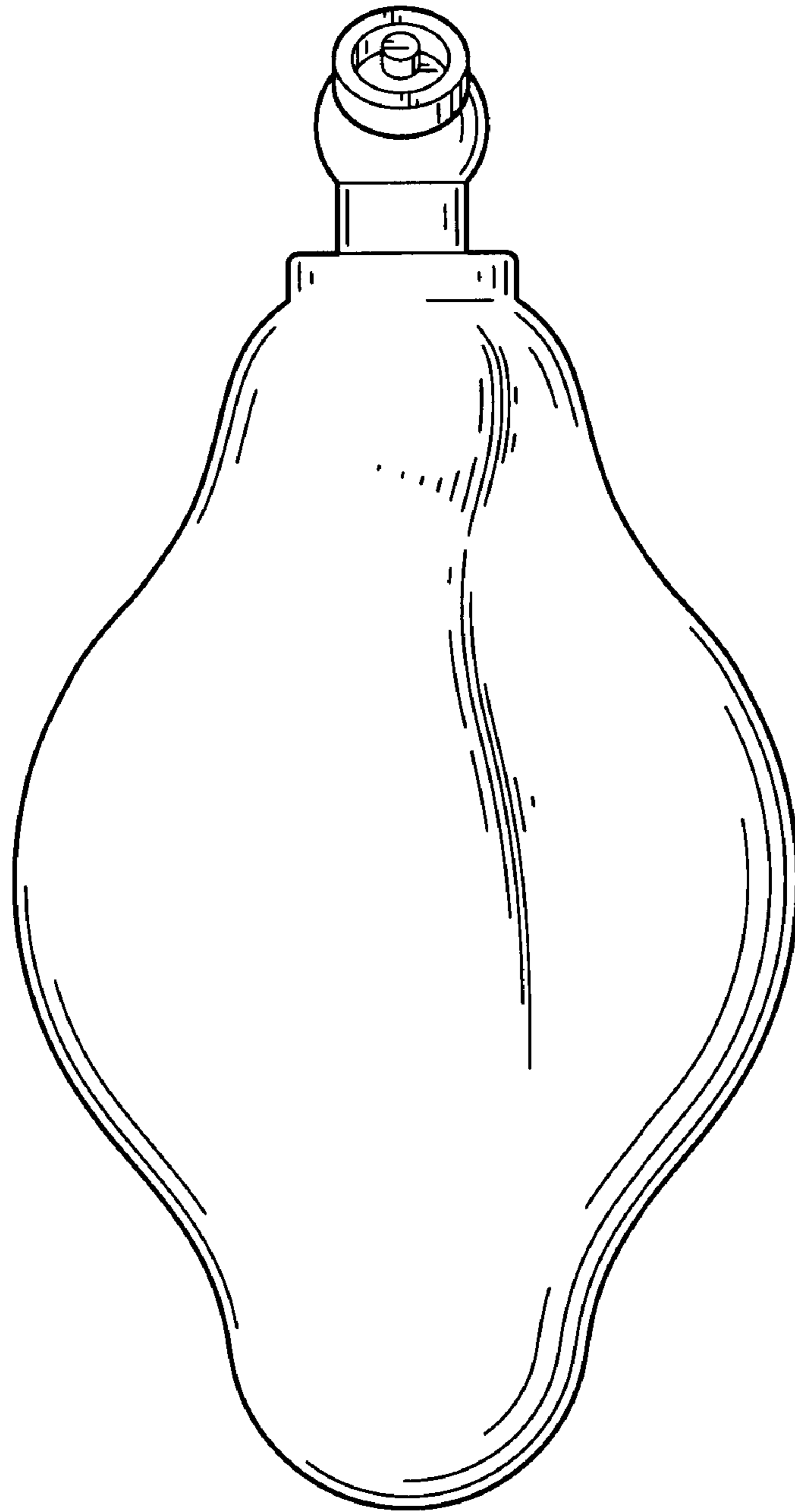

FIG. 4

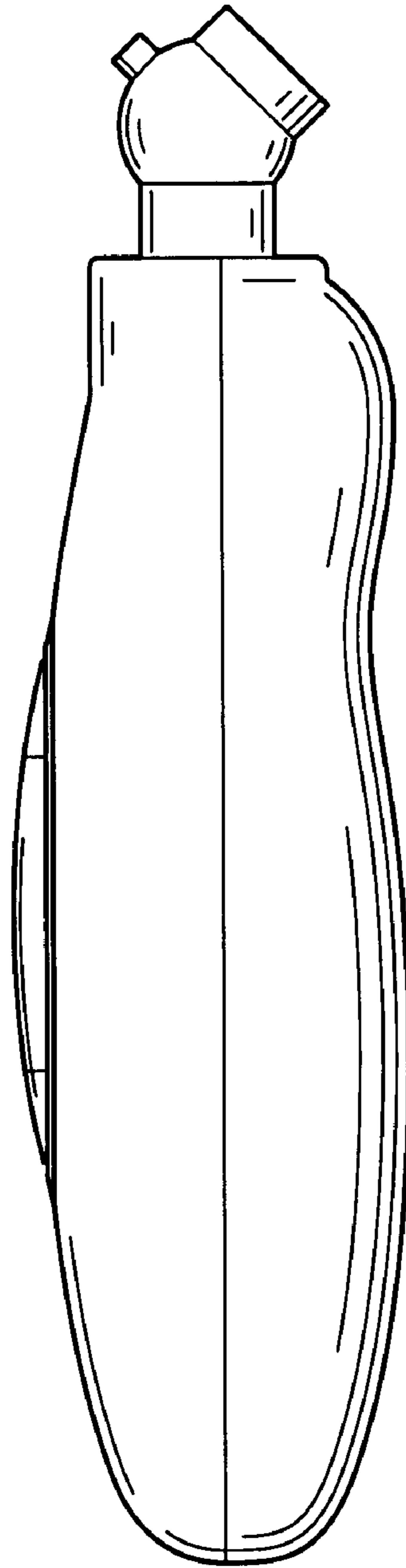

FIG. 5

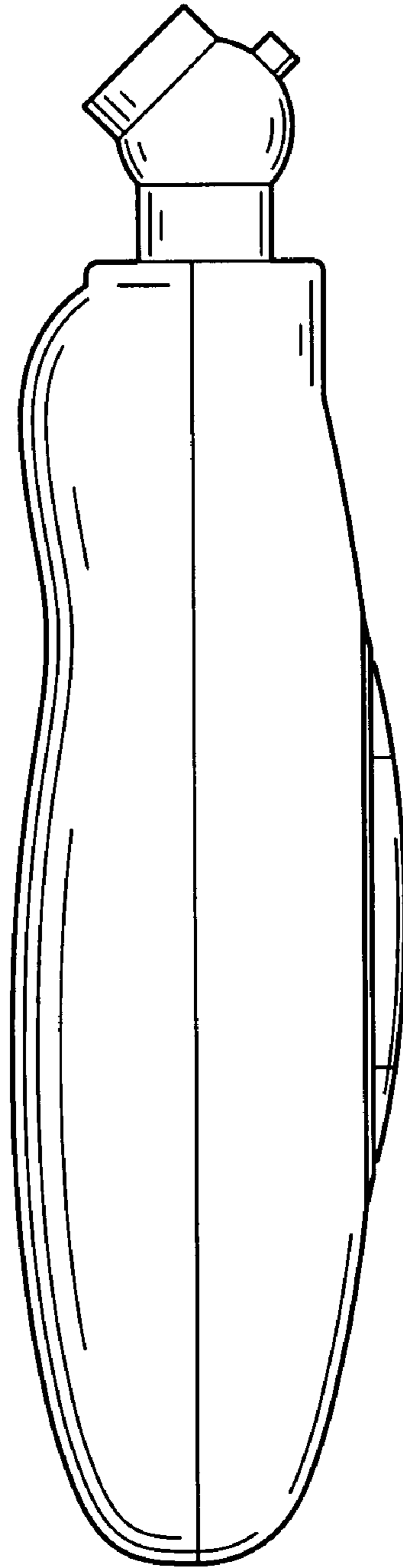

FIG. 6

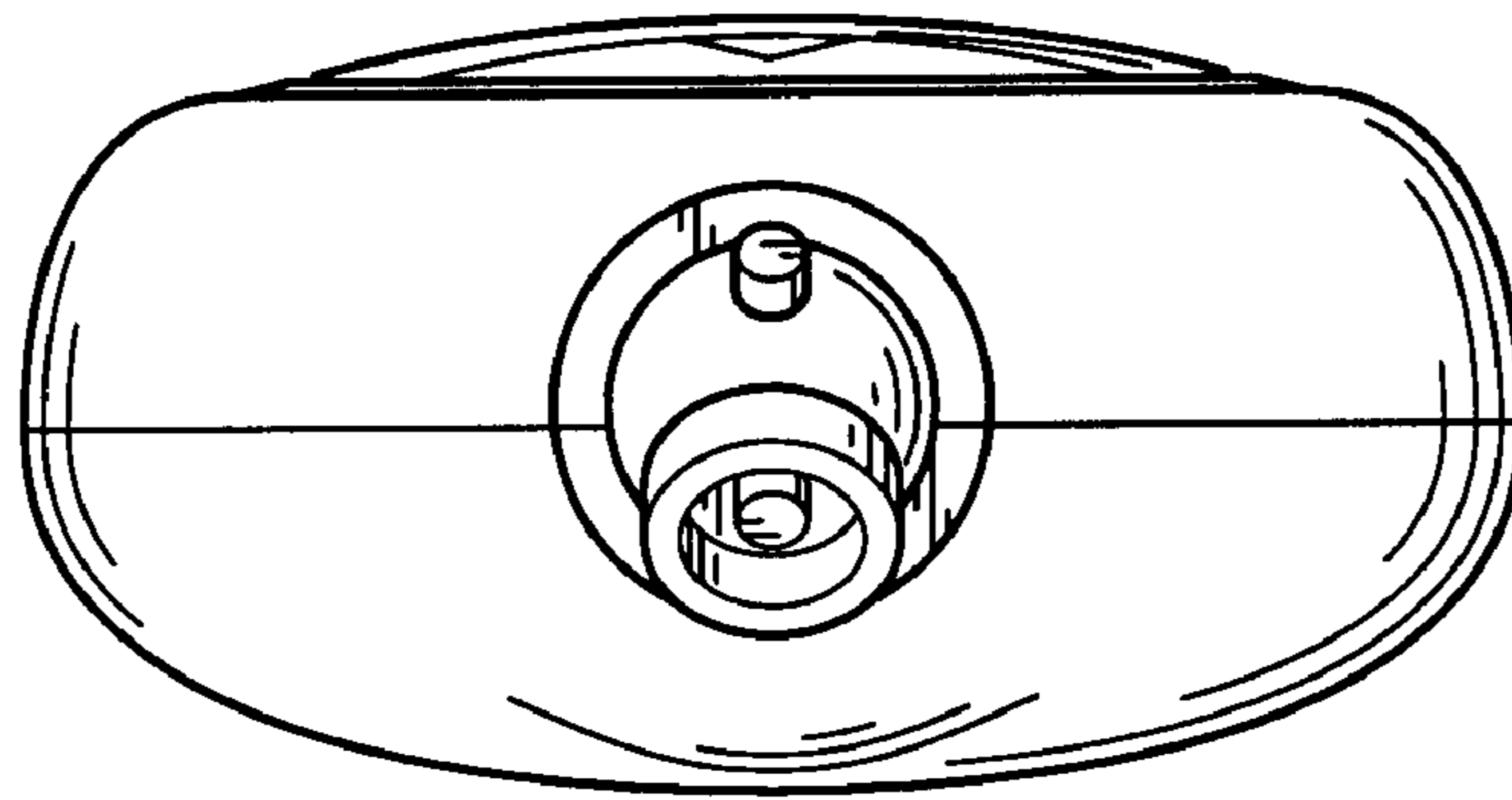

FIG. 7

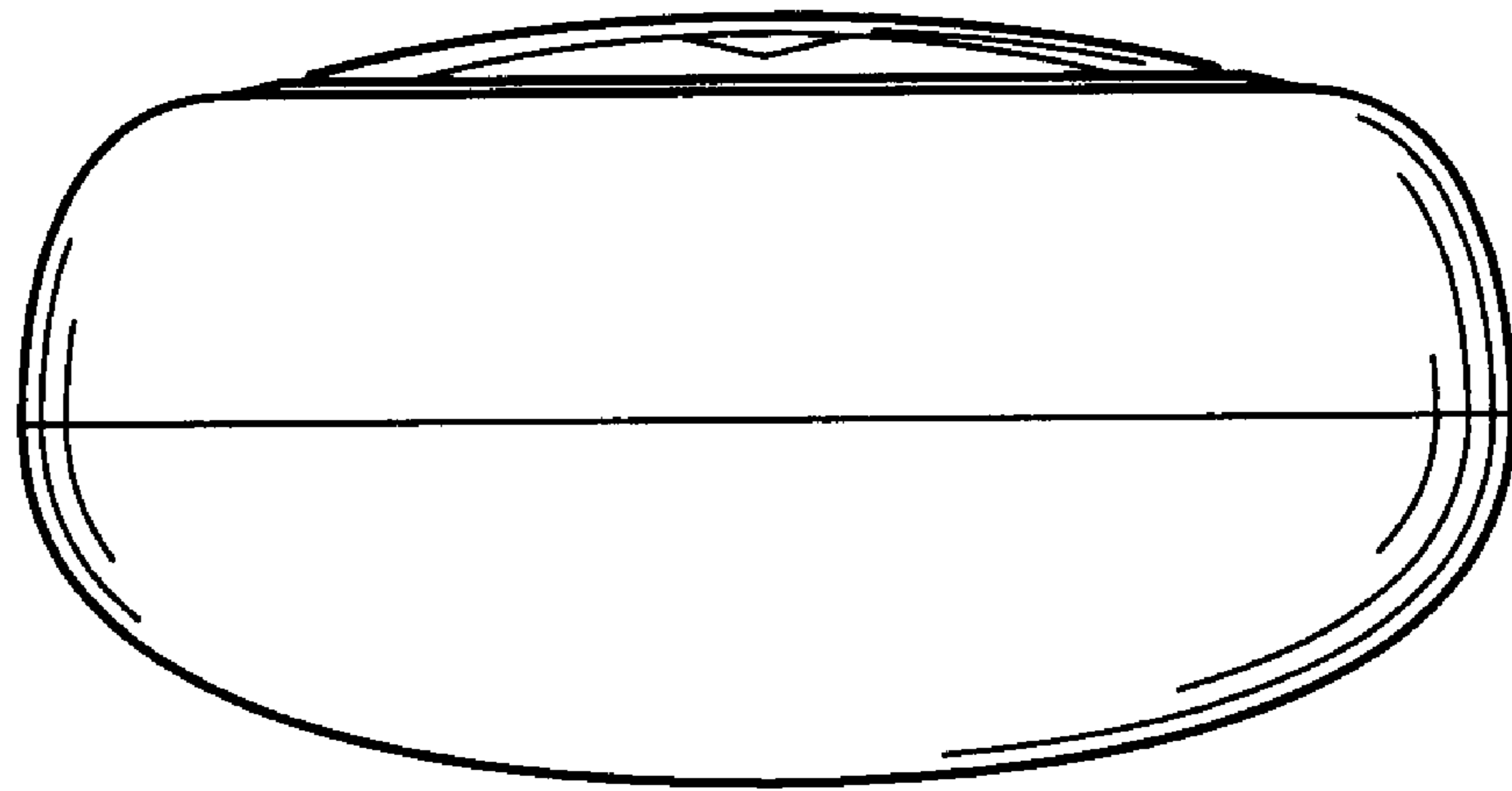

FIG. 8