

US00D505848S

(12) **United States Design Patent**  
**Lee**

(10) **Patent No.:** **US D505,848 S**  
(45) **Date of Patent:** **\*\* Jun. 7, 2005**

(54) **BOTTLE OPENER**

D466,772 S \* 12/2002 Mauffette ..... D8/42

(75) Inventor: **Shek Tang Lee, Tsuen Wan (HK)**

\* cited by examiner

(73) Assignee: **Hung Sang Metal Plastic Factory Limited, Hong Kong (CN)**

*Primary Examiner*—Caron D. Veynar  
(74) *Attorney, Agent, or Firm*—Harrison & Egbert

(\*\*) Term: **14 Years**

(57) **CLAIM**

I claim the ornamental design for a bottle opener, as shown and described.

(21) Appl. No.: **29/201,611**

(22) Filed: **Mar. 19, 2004**

**DESCRIPTION**

(30) **Foreign Application Priority Data**

Sep. 18, 2003 (HK) ..... 0311535

FIG. 1 is a side elevation view of the bottle opener showing my design, an opposite side view being a mirror image thereof.

(51) **LOC (8) Cl.** ..... **07-06**

FIG. 2 is a back view thereof;

(52) **U.S. Cl.** ..... **D8/42; D8/39**

FIG. 3 a front view thereof;

(58) **Field of Search** ..... **D8/16-20, 33-43, D8/98, 99; 7/151-158; 30/400-443; 81/3.07-3.57**

FIG. 4 is a bottom view thereof;

FIG. 5 is a top plan view thereof;

FIG. 6 is an upper perspective view thereof;

FIG. 7 is a rear perspective view thereof; and,

FIG. 8 is another rear perspective view thereof in the releasing position.

(56) **References Cited**

**U.S. PATENT DOCUMENTS**

D445,008 S \* 7/2001 Andina et al. .... D8/42  
D463,235 S \* 9/2002 Mauffette ..... D8/40

**1 Claim, 4 Drawing Sheets**

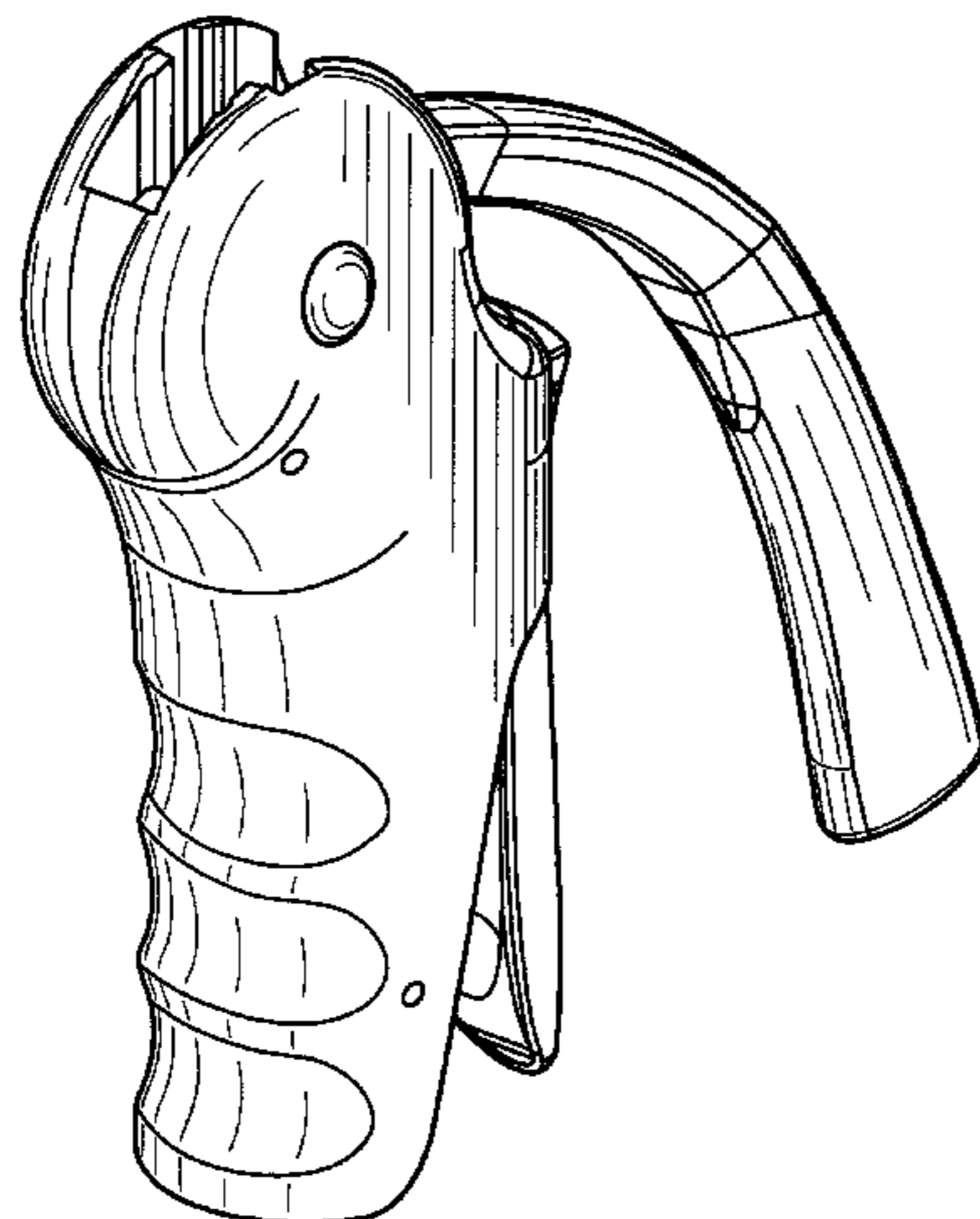
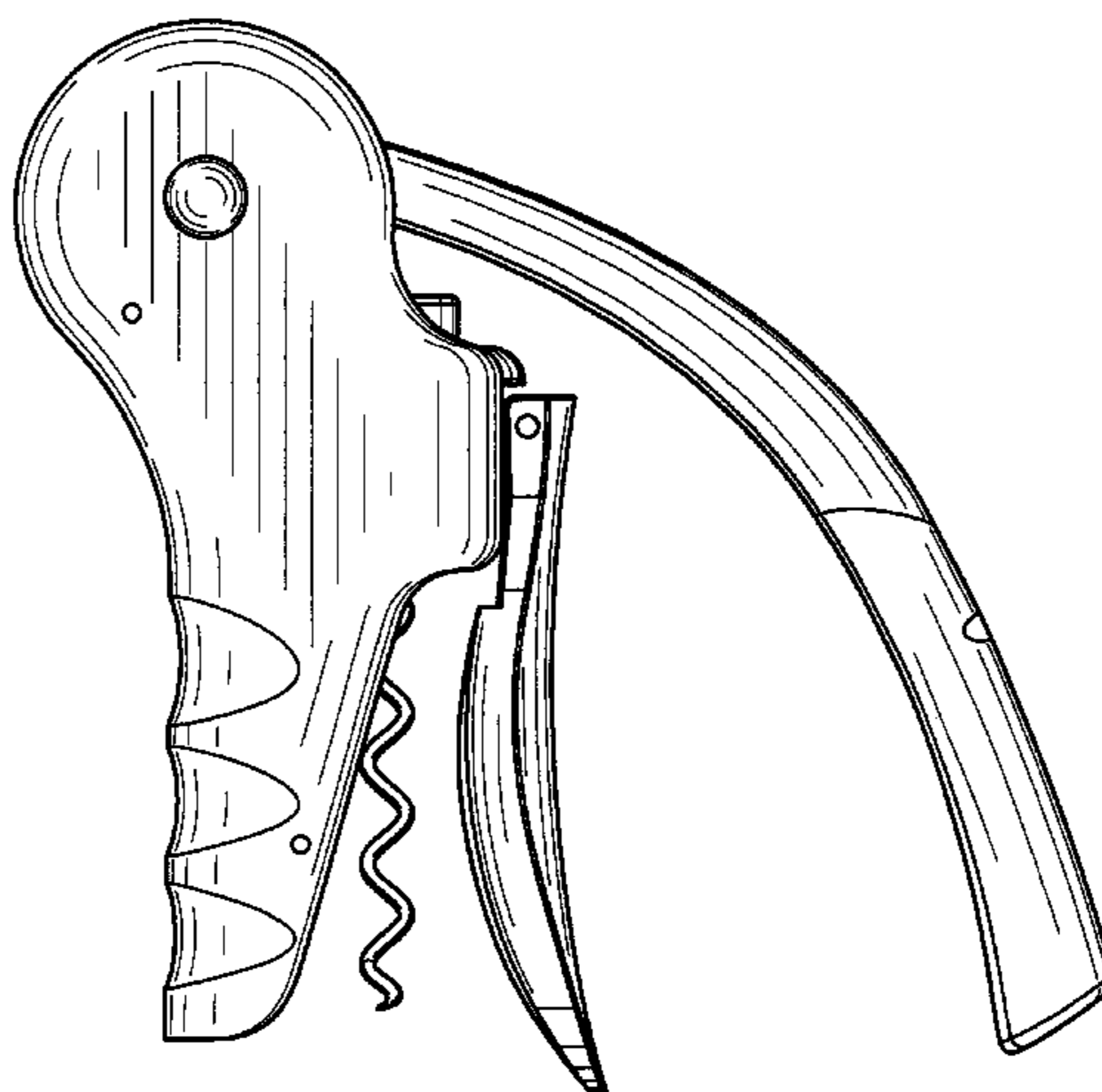

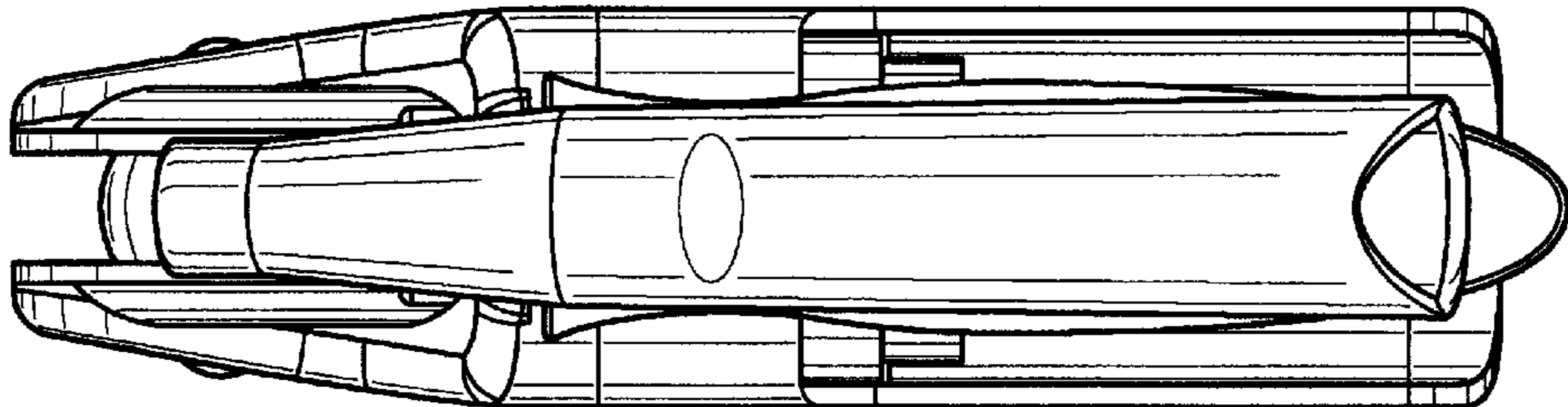

FIG. 2

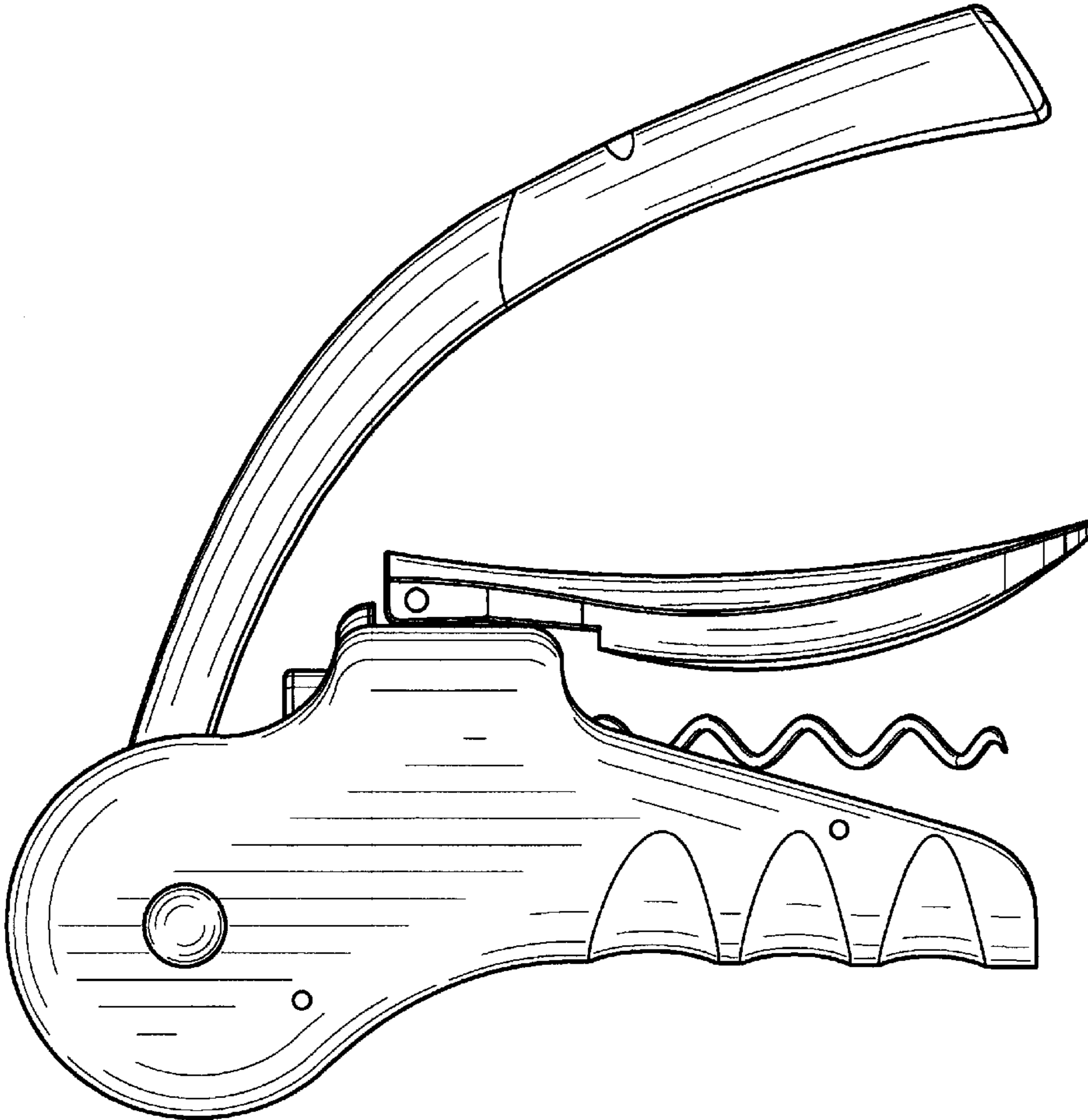

FIG. 1

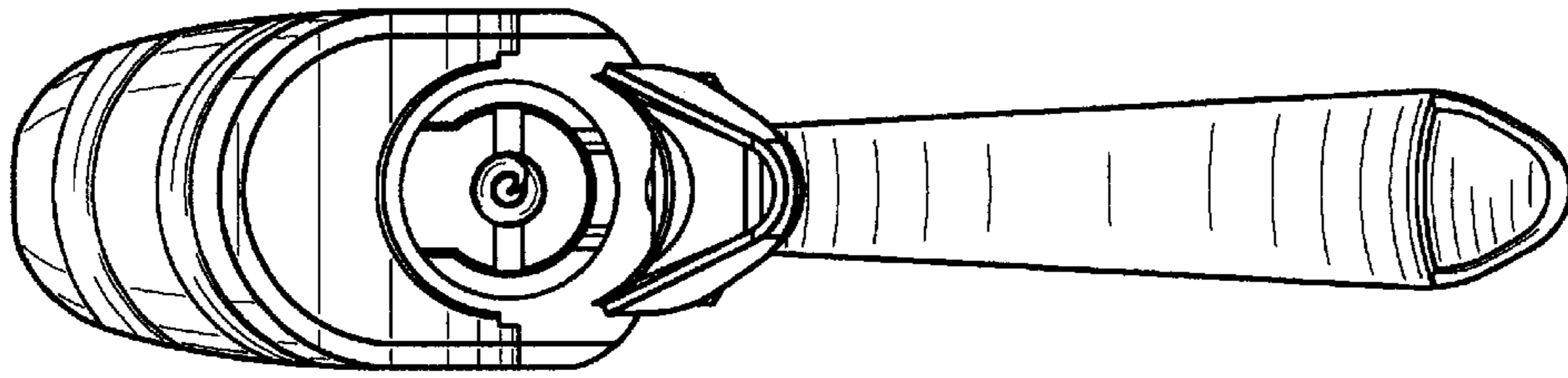

FIG. 4

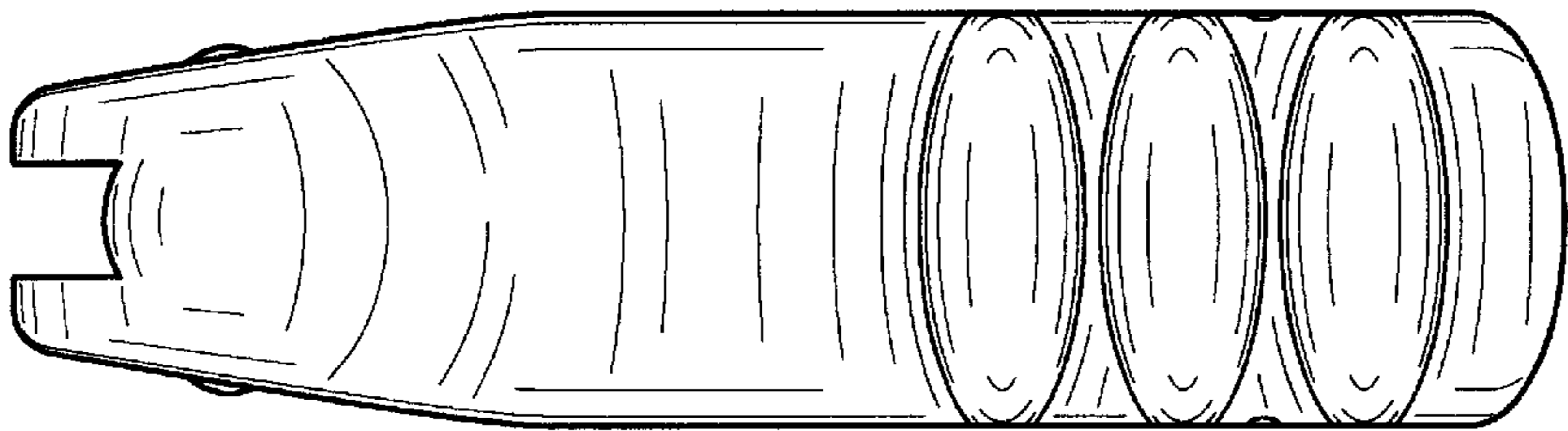

FIG. 3

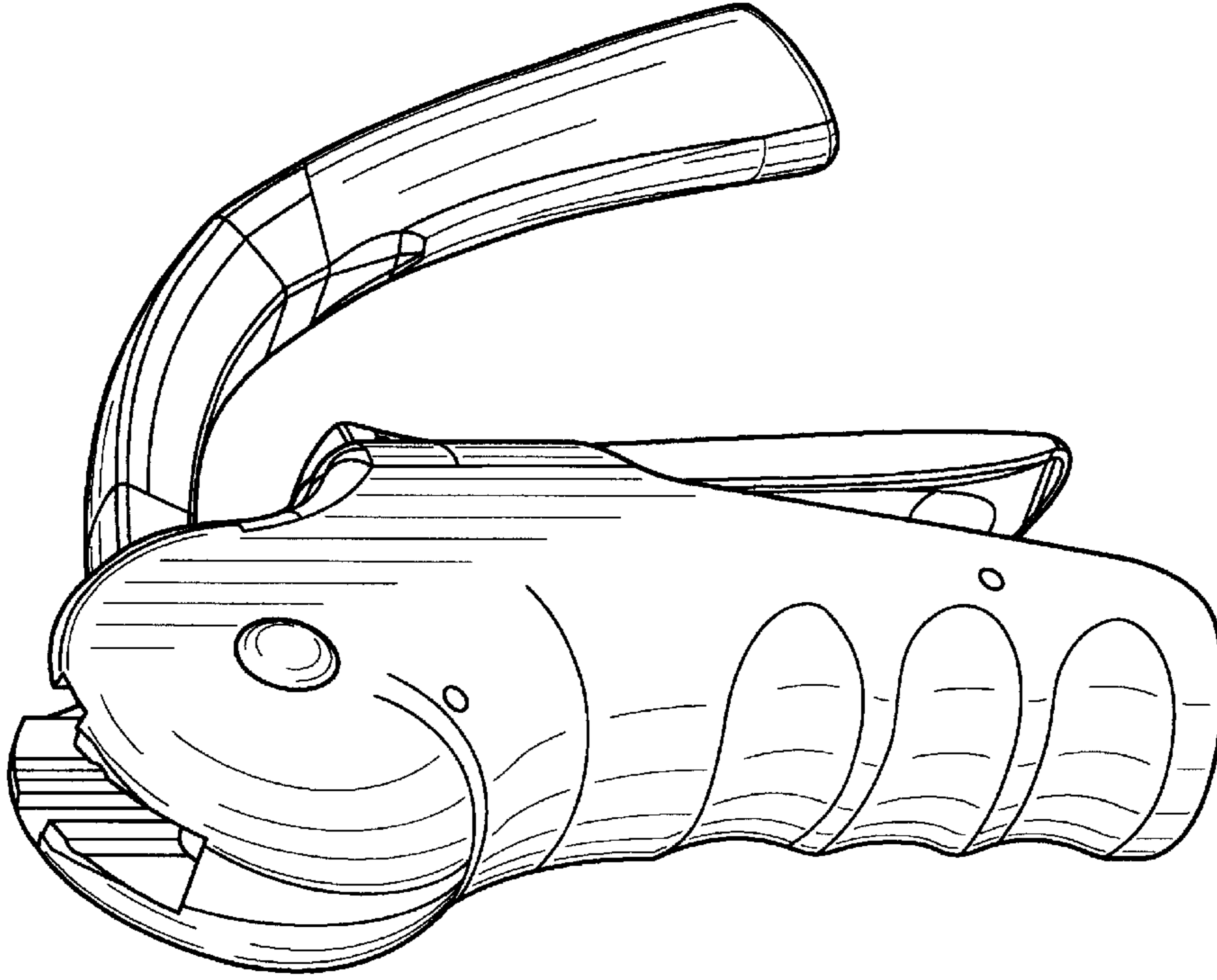

FIG. 6

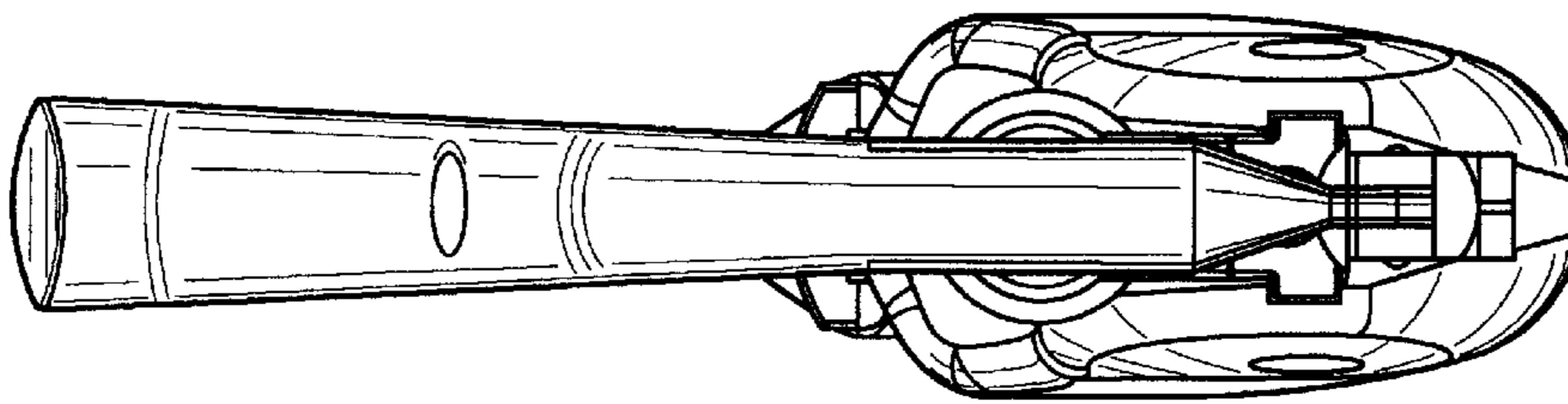

FIG. 5

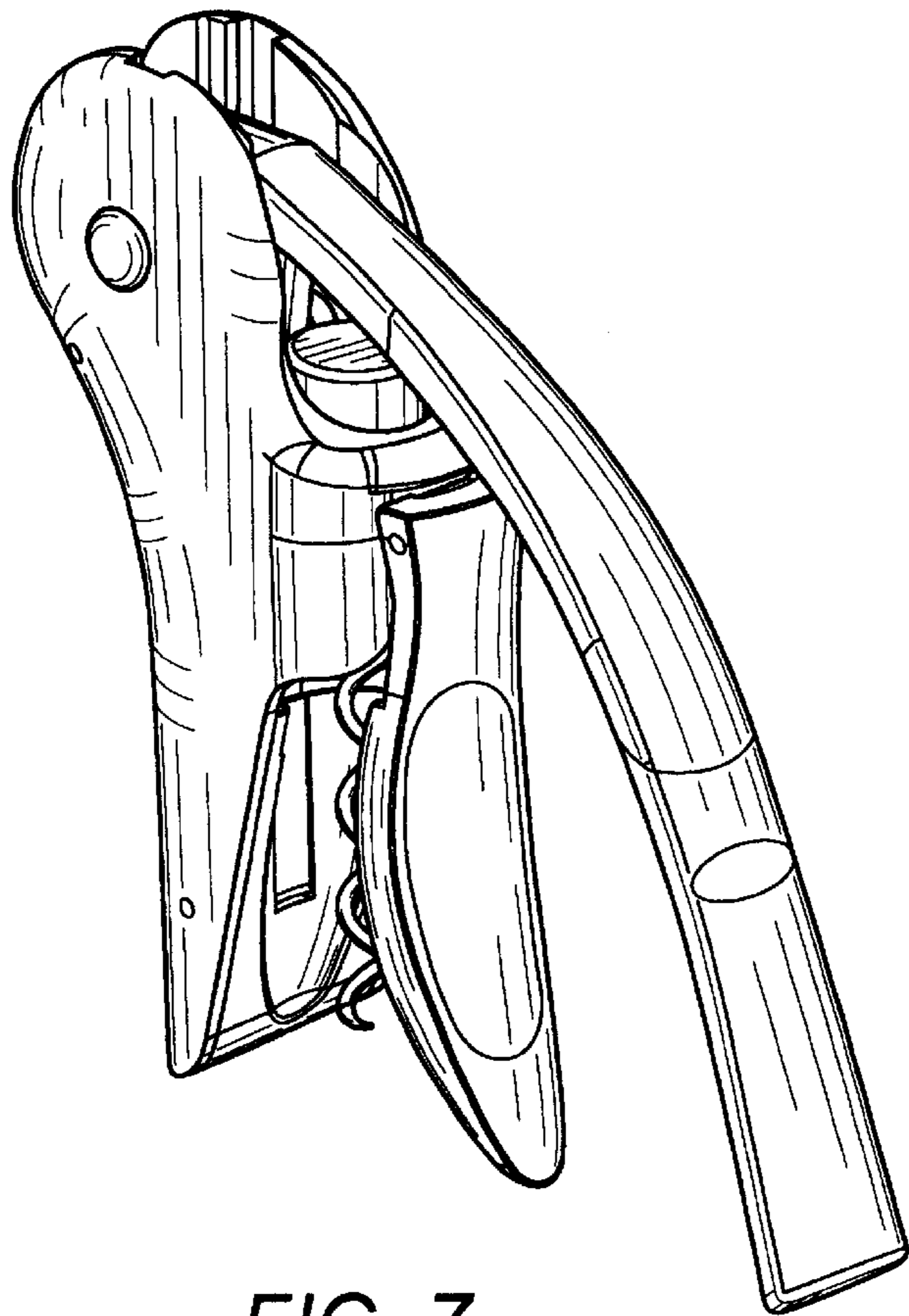

FIG. 7

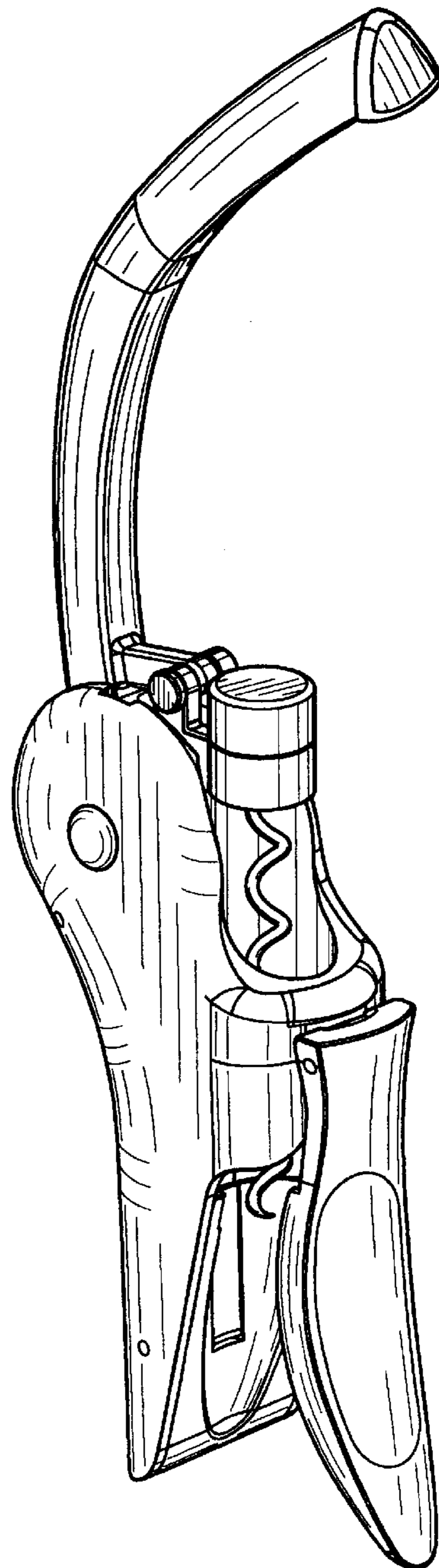

FIG. 8