

US00D505784S

(12) **United States Design Patent**
Yeh

(10) **Patent No.:** **US D505,784 S**
(45) **Date of Patent:** **** Jun. 7, 2005**

(54) **KEY RING HOLDER WITH MULTIPURPOSE TOOLS**

D477,133 S * 7/2003 Yeh D3/211

* cited by examiner

(76) **Inventor:** **Shih-Yuan Yeh**, No. 260, Chen-Fu Rd.,
Tai-Ping City, Taichung Hsien (TW)

Primary Examiner—Ralf Seifert

(74) *Attorney, Agent, or Firm*—William E. Pelton

(**) **Term:** **14 Years**

(57) **CLAIM**

(21) **Appl. No.:** **29/191,396**

The ornamental design for a key ring holder with multipurpose tools, as shown and described.

(22) **Filed:** **Oct. 7, 2003**

DESCRIPTION

(51) **LOC (8) Cl.** **03-01**

(52) **U.S. Cl.** **D3/211; D3/210**

(58) **Field of Search** D11/1-2, 40-43,
D11/44, 48-49, 53, 56-57, 59, 60, 63,
65, 79-82, 83, 91, 95-97, 99-101, 106,
114-115; 63/1.11, 18-20; D3/207-211

FIG. 1 is a perspective view of a key ring holder with multipurpose tools, showing my new design; FIG. 2 is a front elevational view thereof; FIG. 3 is a rear elevational view thereof; FIG. 4 is a left side elevational view thereof; FIG. 5 is a right side elevational view thereof; FIG. 6 is a top plan view thereof; FIG. 7 is a bottom plan view thereof; and, FIG. 8 is a referential operational front elevation view thereof when the multipurpose tools are separated outside, wherein the broken lines are shown for illustrative purposes only and form no part of the claimed design.

(56) **References Cited**

U.S. PATENT DOCUMENTS

- D183,333 S * 8/1958 Walker D3/210
- D404,793 S * 1/1999 Oh D22/141
- D424,657 S * 5/2000 Kang et al. D22/141
- D443,019 S * 5/2001 Kang et al. D22/141
- D446,436 S * 8/2001 Christianson D8/105

1 Claim, 6 Drawing Sheets

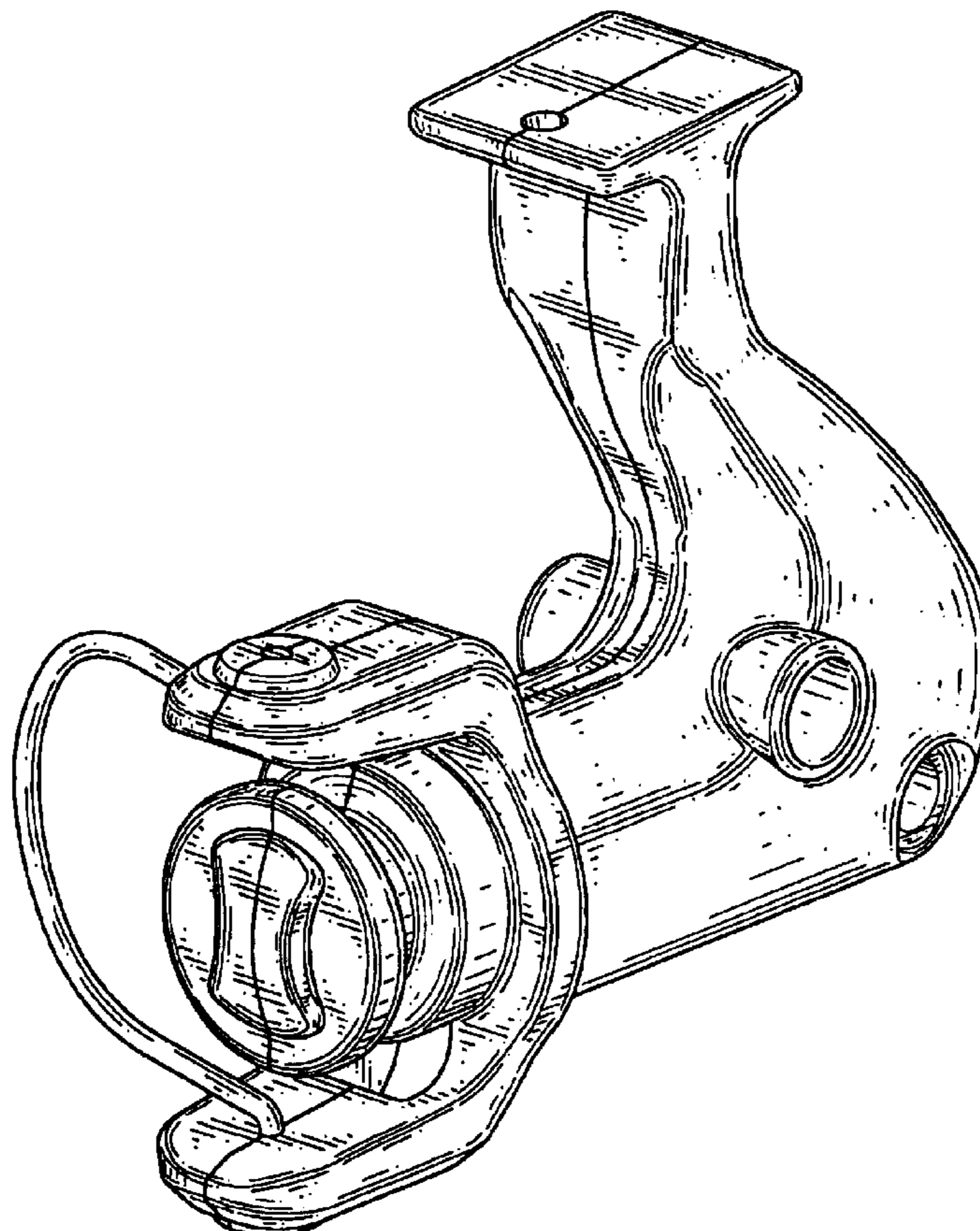

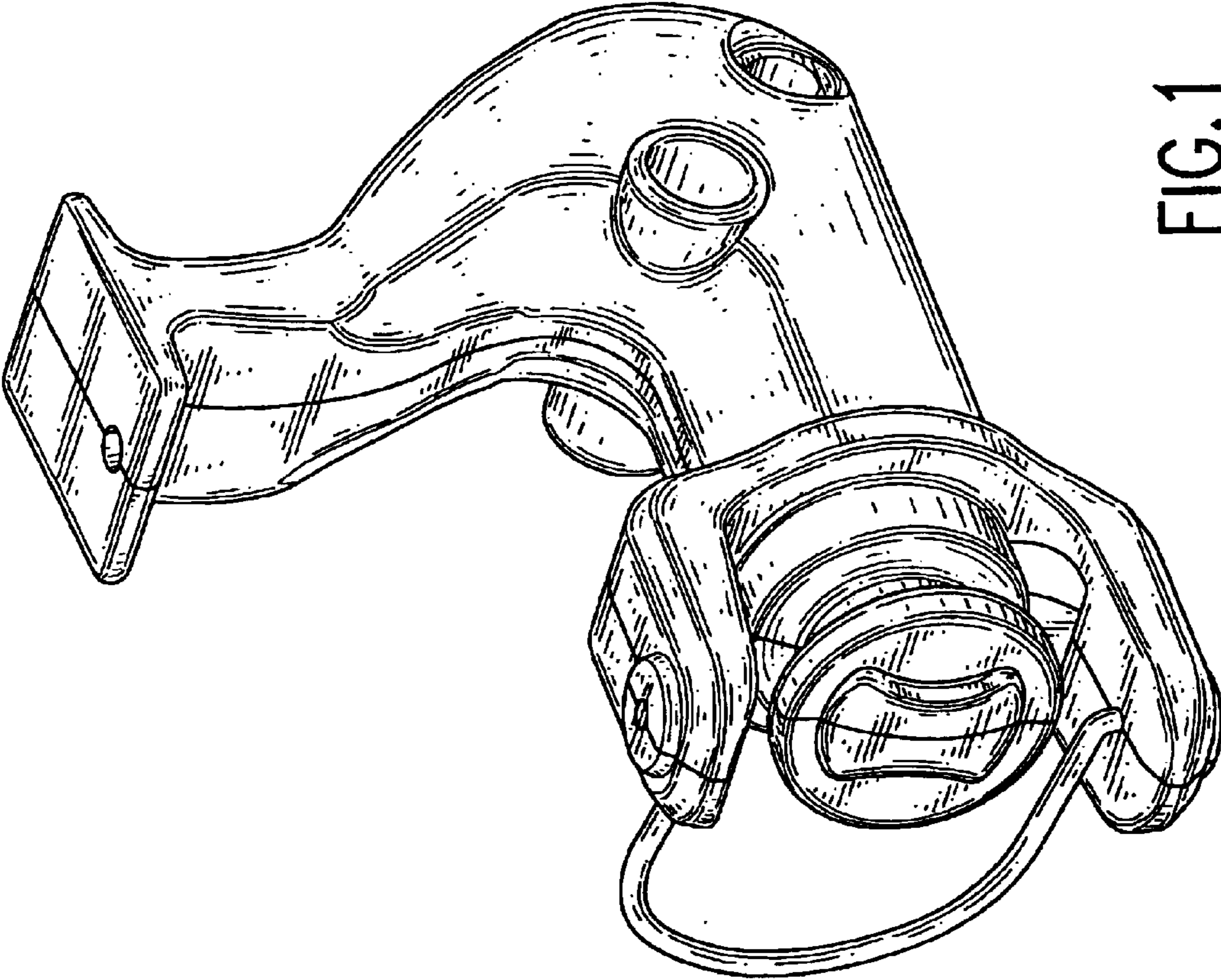

FIG. 1

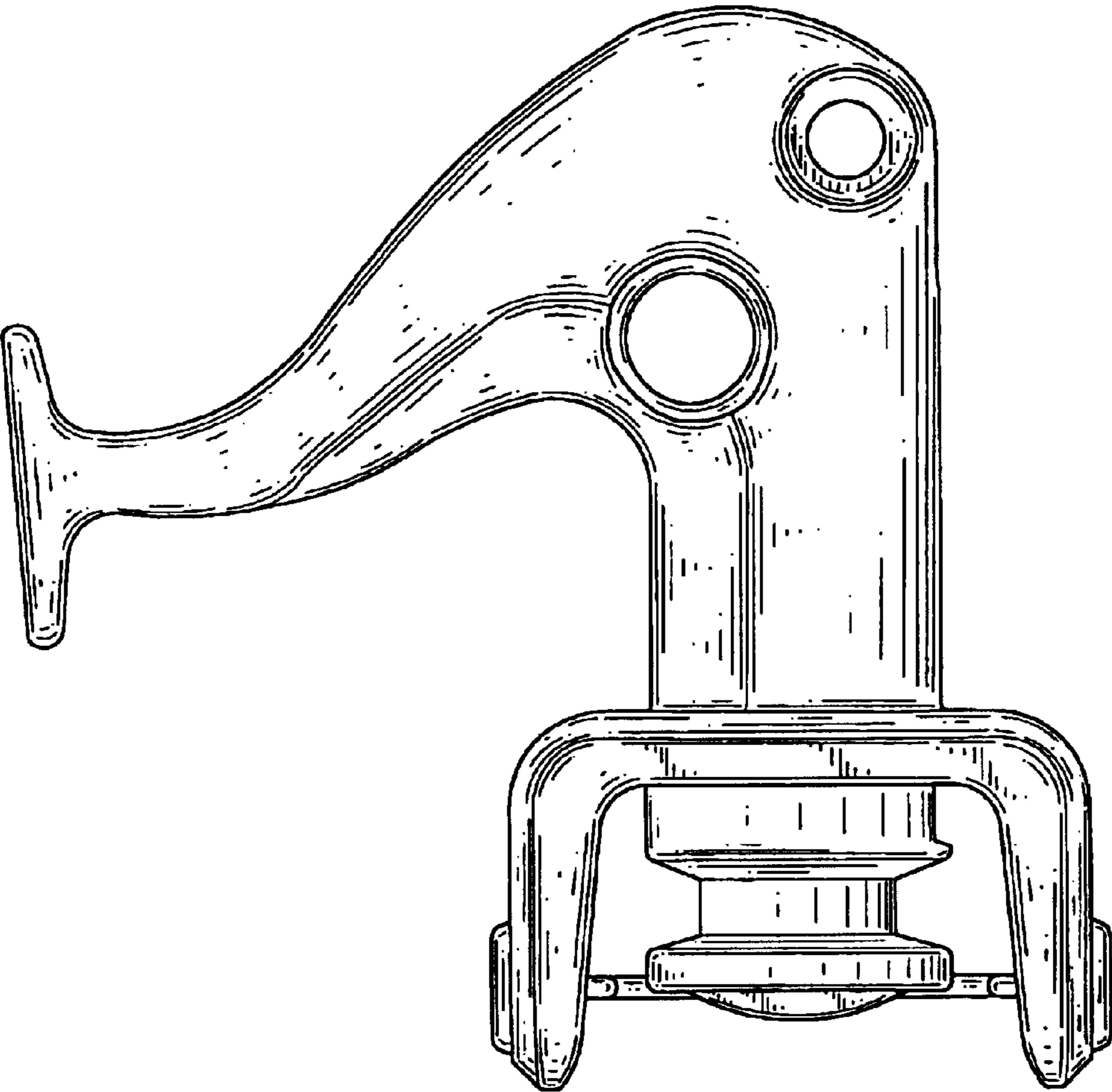

FIG.2

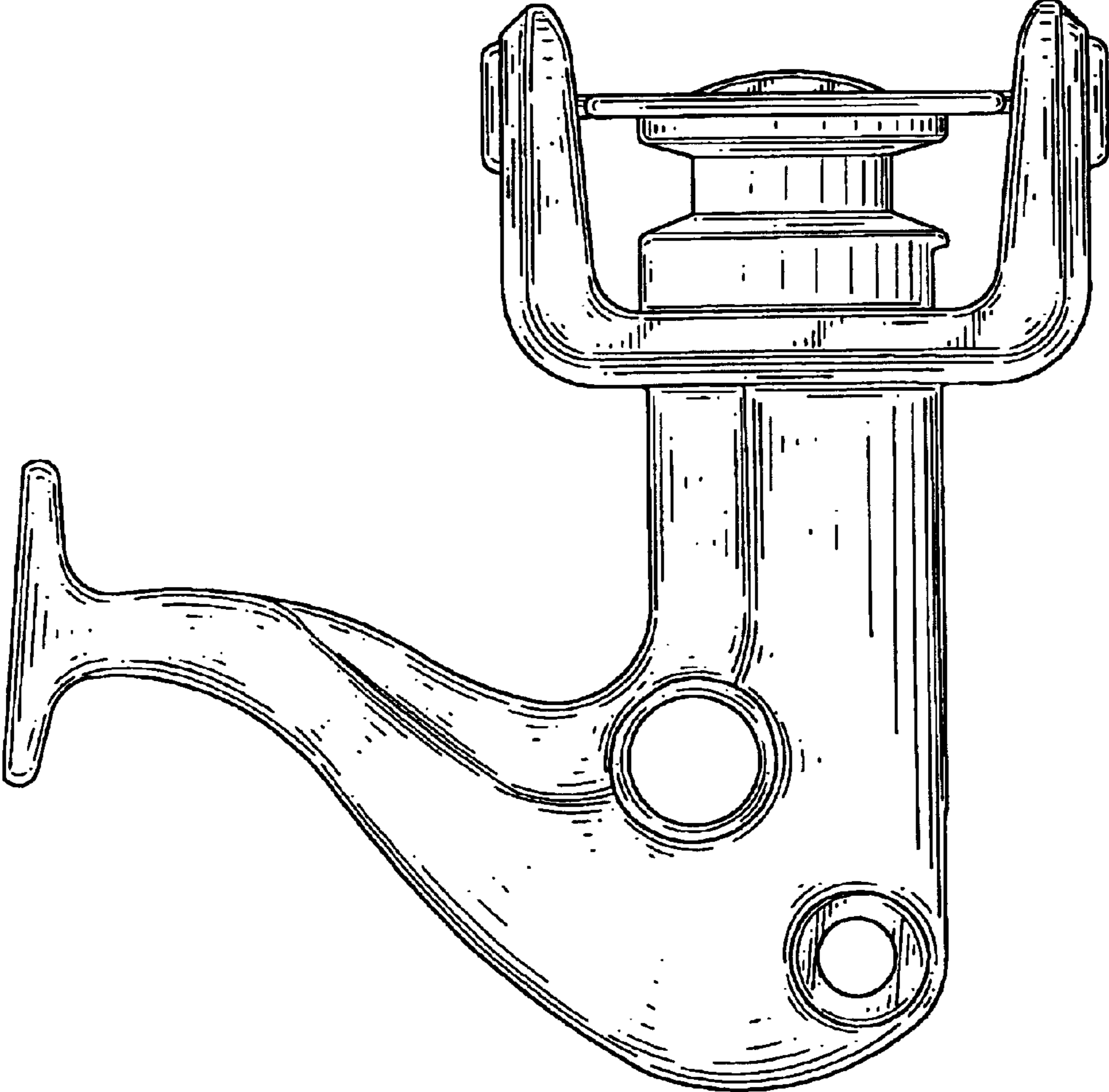

FIG. 3

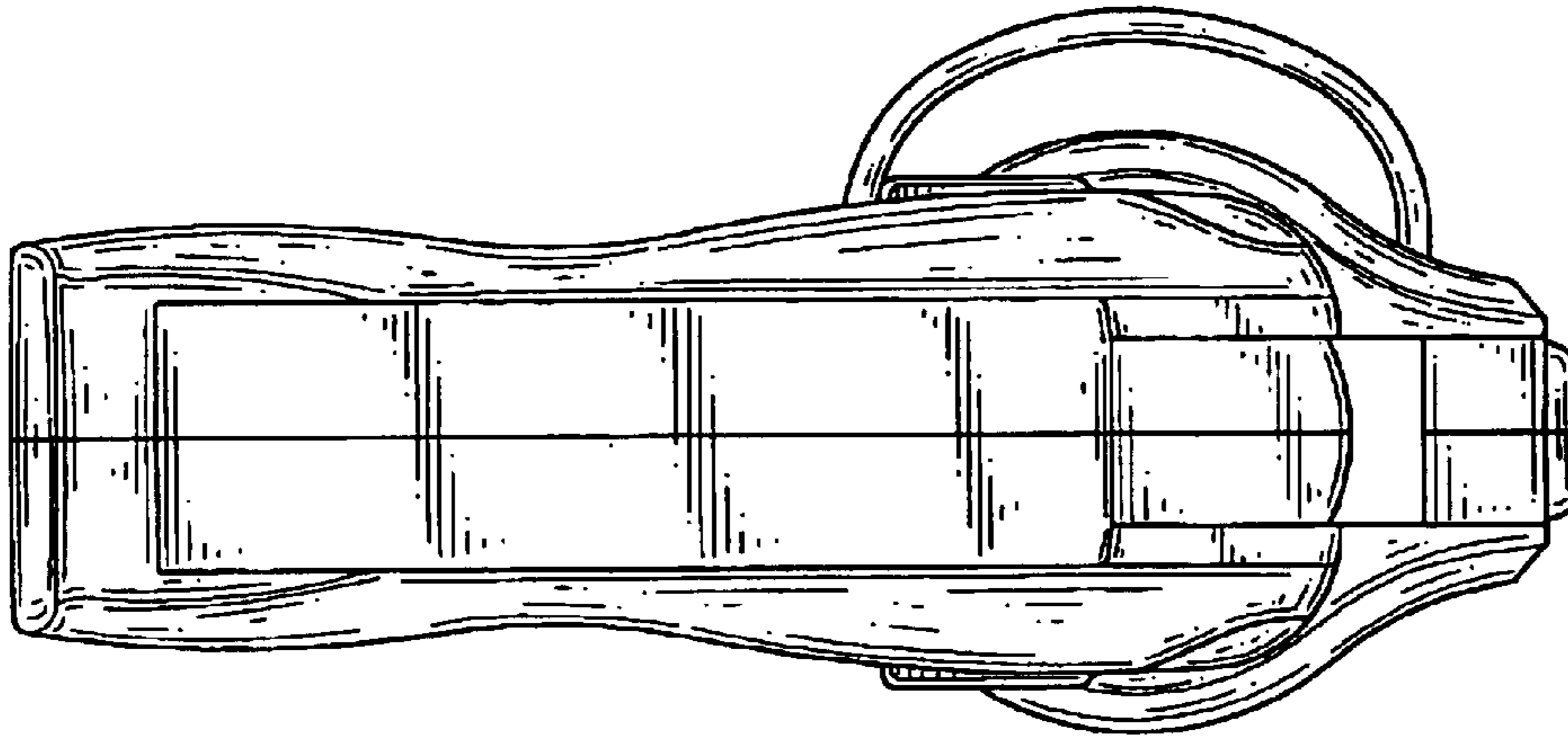

FIG.5

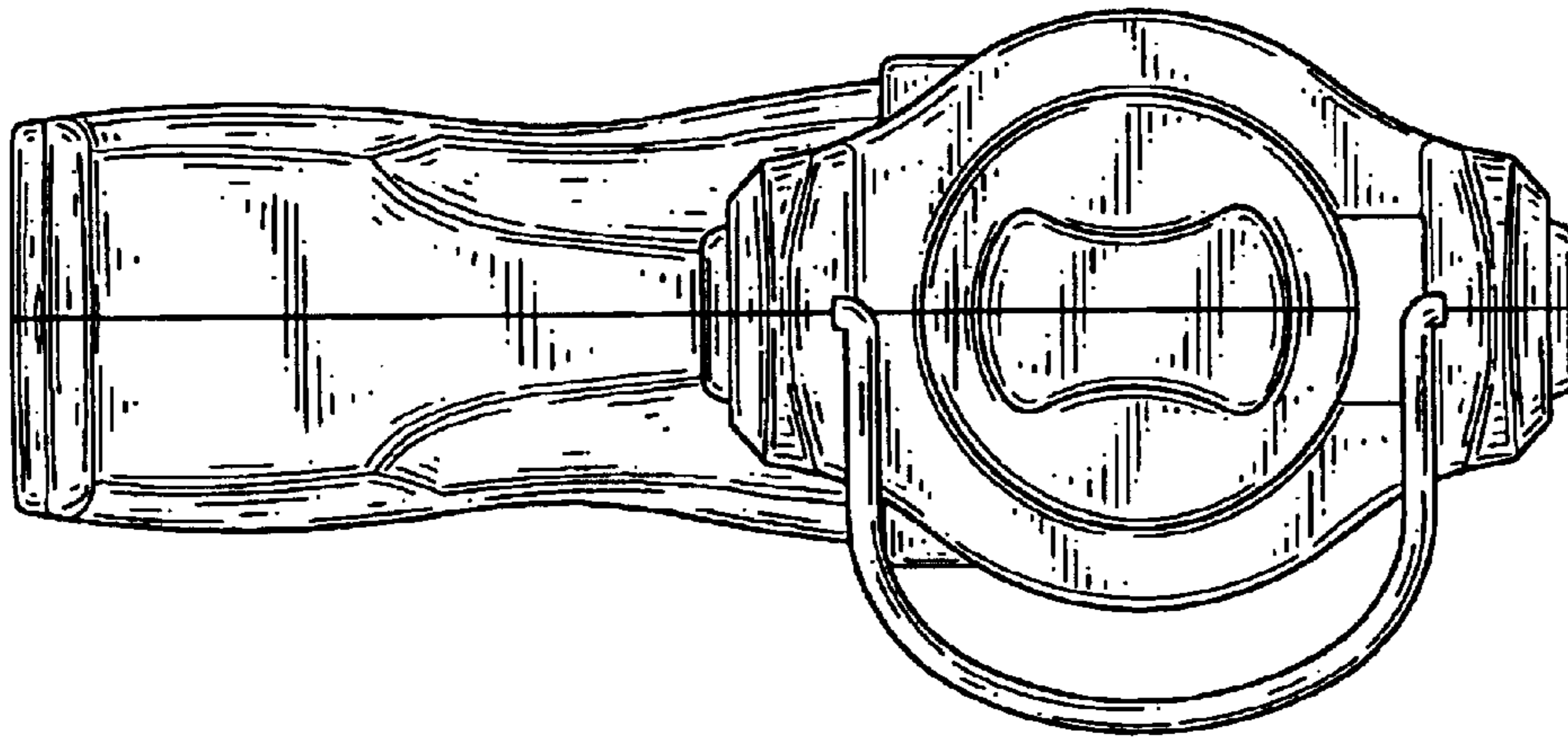

FIG.4

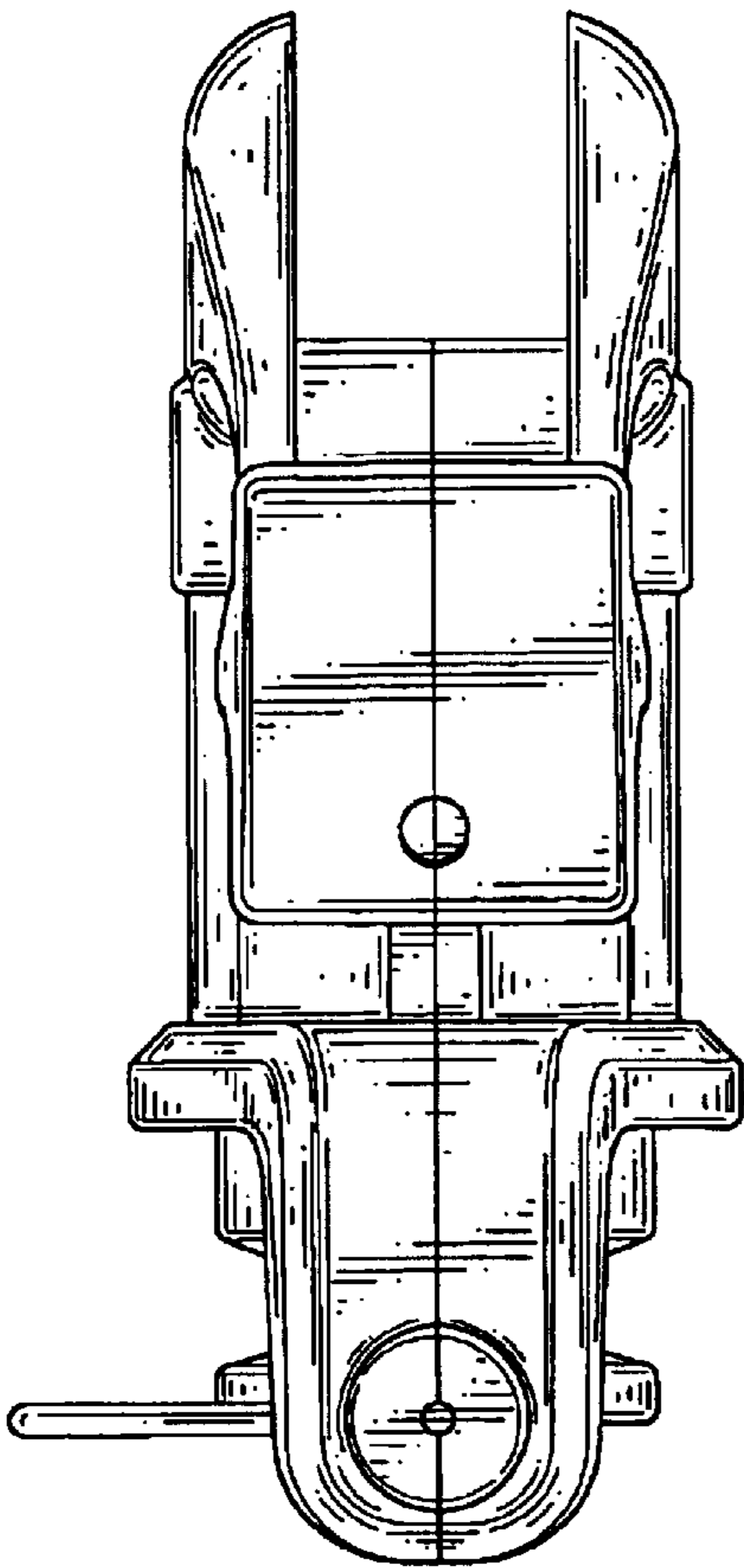

FIG. 6

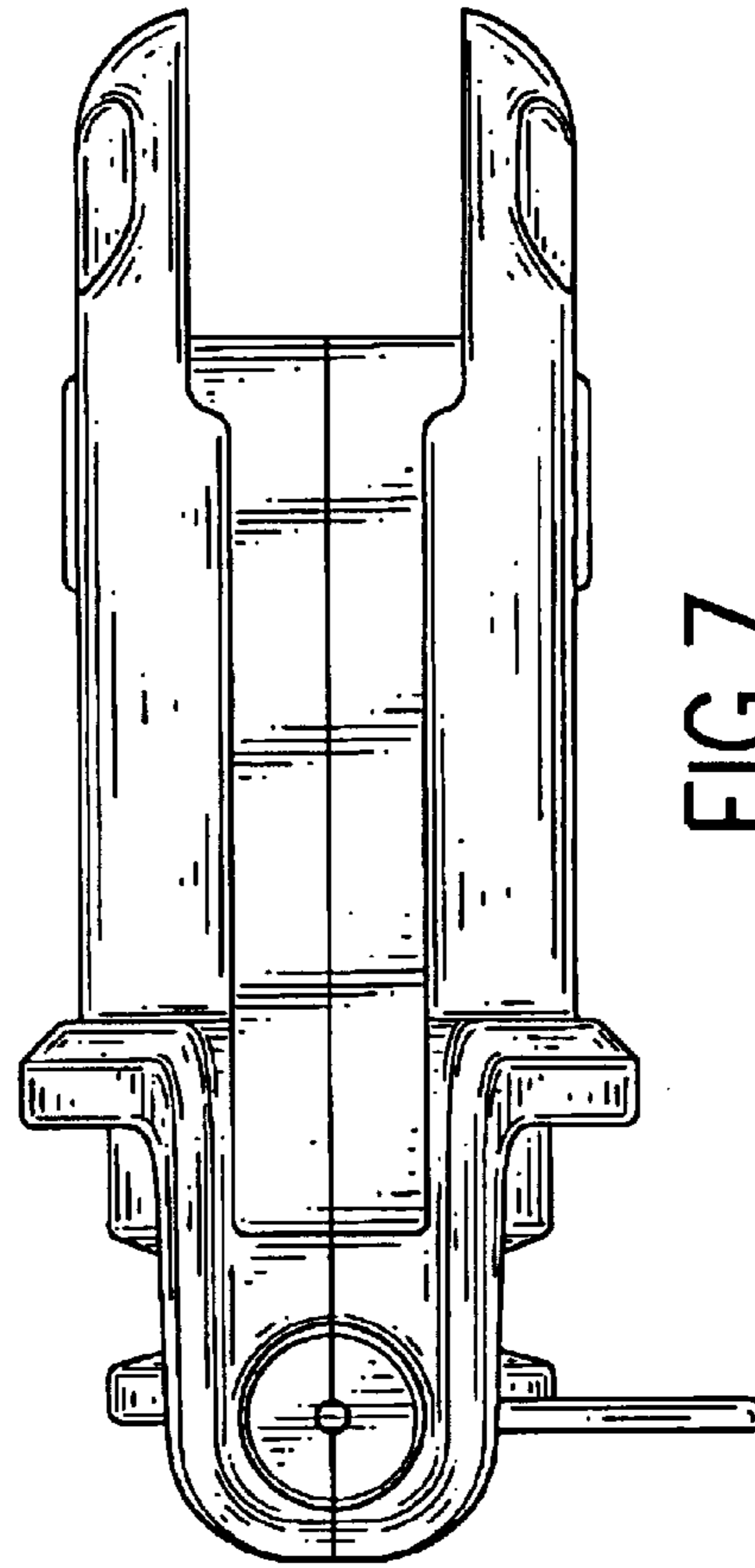

FIG. 7

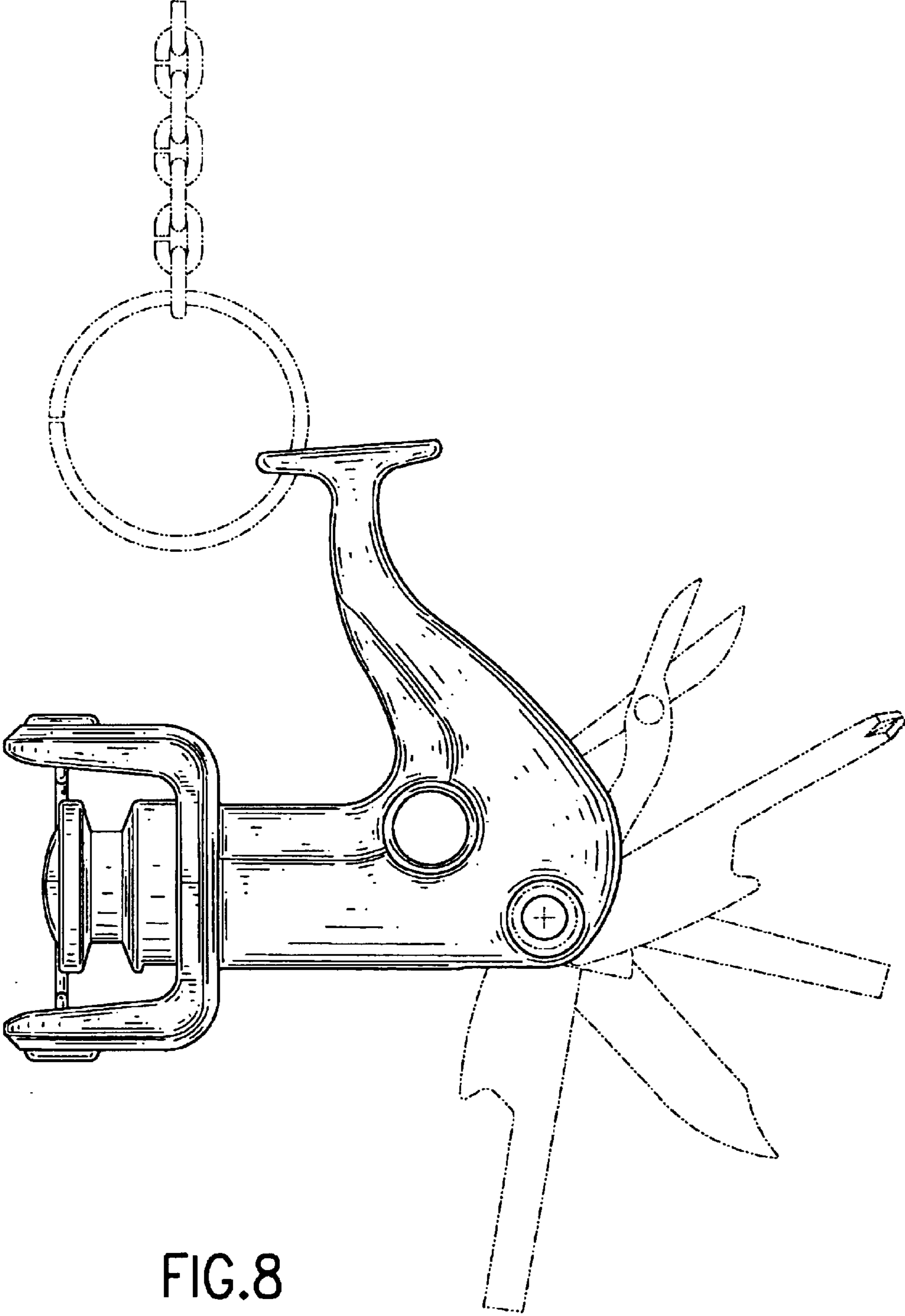

FIG. 8