

US00D505726S

(12) **United States Design Patent**
Ryan

(10) **Patent No.:** **US D505,726 S**

(45) **Date of Patent:** **** May 31, 2005**

(54) **ELECTROTHERAPY AND/OR ULTRASOUND THERAPY PRODUCT CONSOLE**

(75) Inventor: **Bradley Peter Ryan, Sydney (AU)**

(73) Assignee: **Encore Medical Asset Corporation, Henderson, NV (US)**

(**) Term: **14 Years**

(21) Appl. No.: **29/211,376**

(22) Filed: **Aug. 16, 2004**

Related U.S. Application Data

(62) Division of application No. 29/192,462, filed on Oct. 27, 2003.

(51) **LOC (7) Cl.** **24-01**

(52) **U.S. Cl.** **D24/200**

(58) **Field of Search** D24/200, 170, D24/144, 133, 185, 186; 606/32

(56) **References Cited**

U.S. PATENT DOCUMENTS

D359,353 S	*	6/1995	Butter	D24/144
D461,895 S	*	8/2002	Barnes et al.	D24/158
D477,408 S	*	7/2003	Bromley	D24/170
D489,816 S	*	5/2004	Ross	D24/107

* cited by examiner

Primary Examiner—Louis S. Zarfes
Assistant Examiner—John Windmuller

(74) *Attorney, Agent, or Firm*—Chambliss, Bahner & Stophel, P.C.

(57) **CLAIM**

The ornamental design for an electrotherapy and/or ultrasound therapy product console, as shown.

DESCRIPTION

FIG. 1 is a perspective view of the product console of my new design.

FIG. 2 is a front view of the product console of my new design.

FIG. 3 is a right side view of the product console of my new design.

FIG. 4 is a left side view of the product console of my new design.

FIG. 5 is a rear view of the the product console of my new design.

FIG. 6 is a top view of the product console of my new design; and,

FIG. 7 is a bottom view of the product console of my new design.

1 Claim, 7 Drawing Sheets

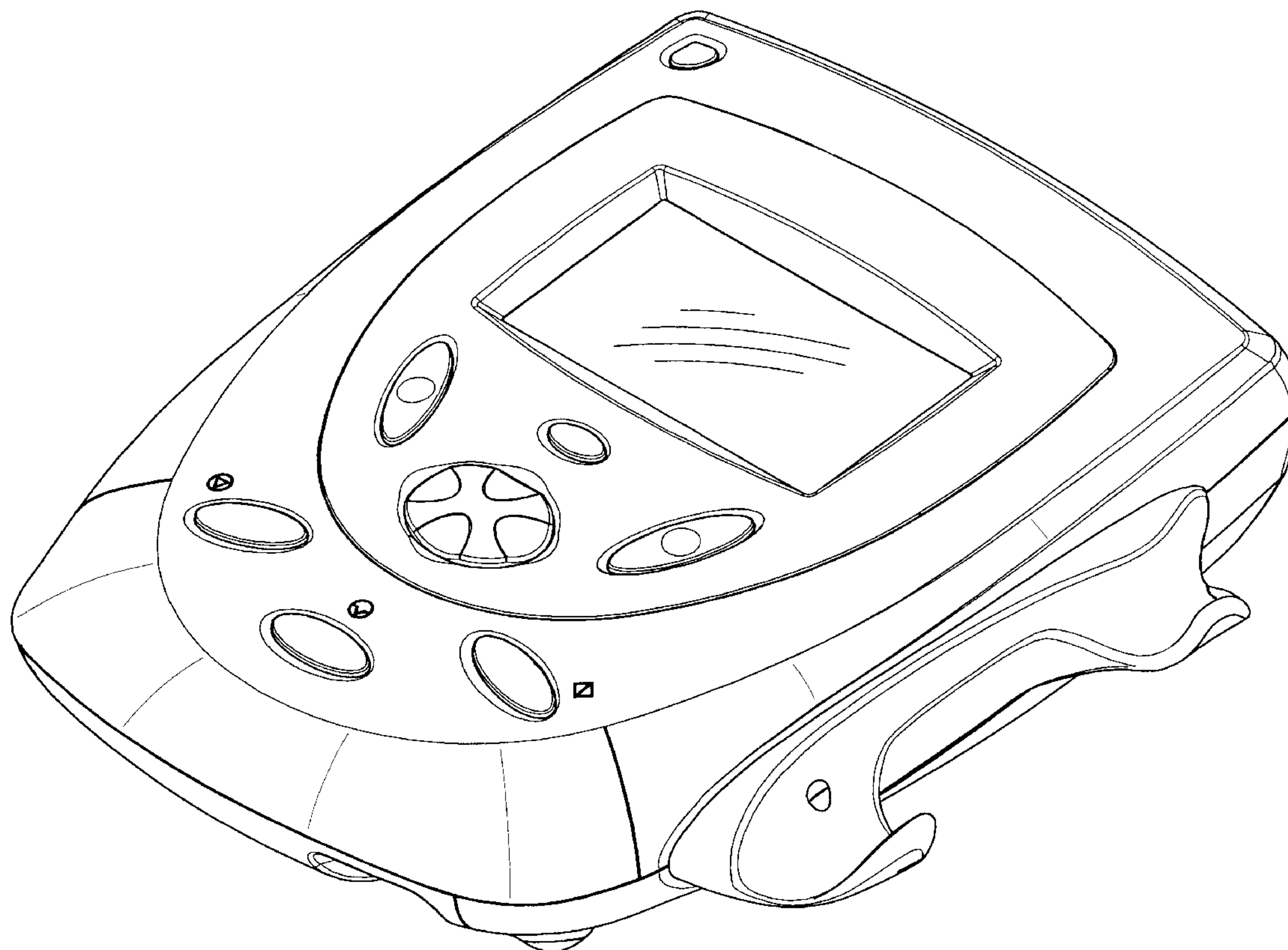

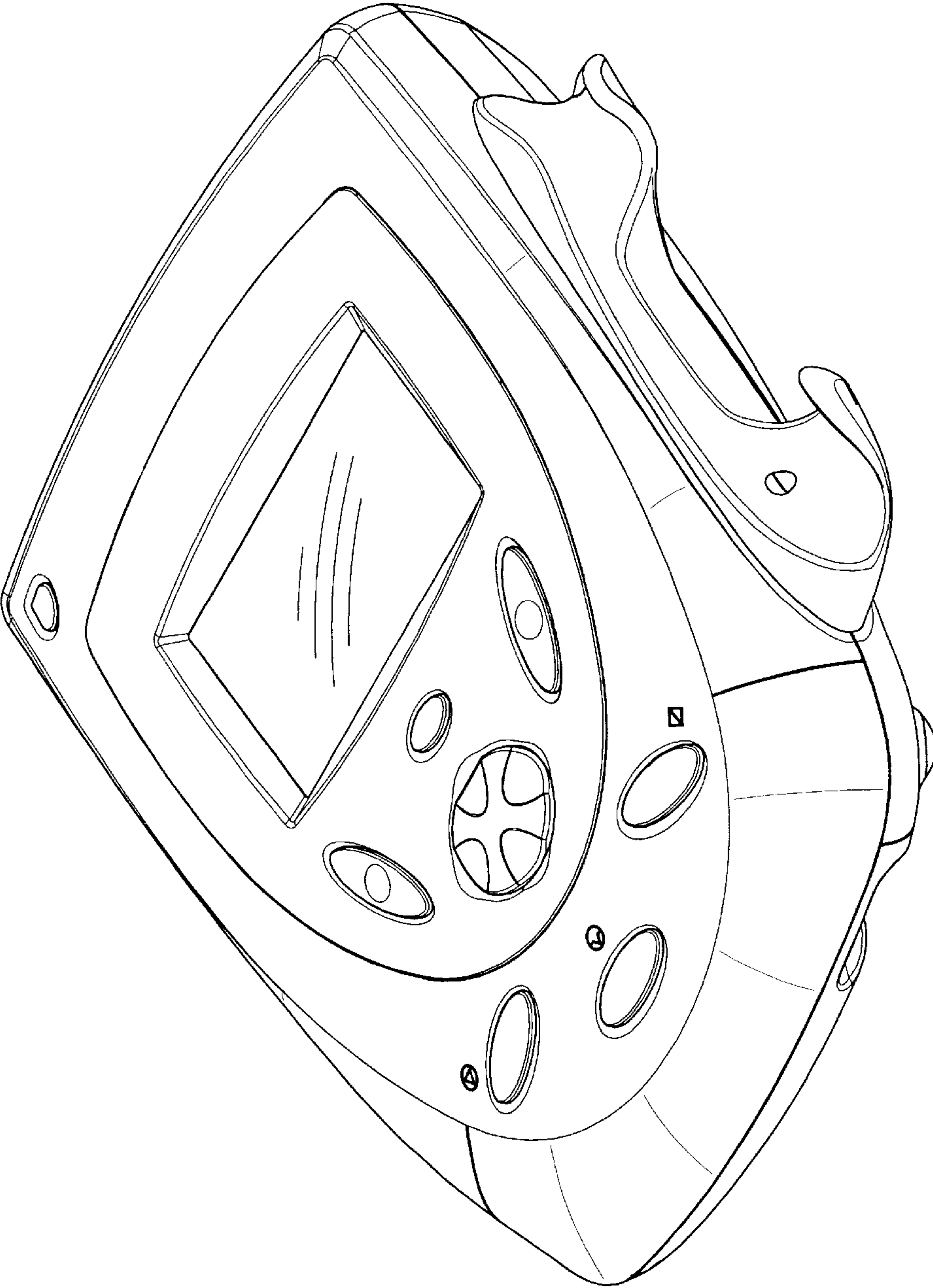

FIGURE 1

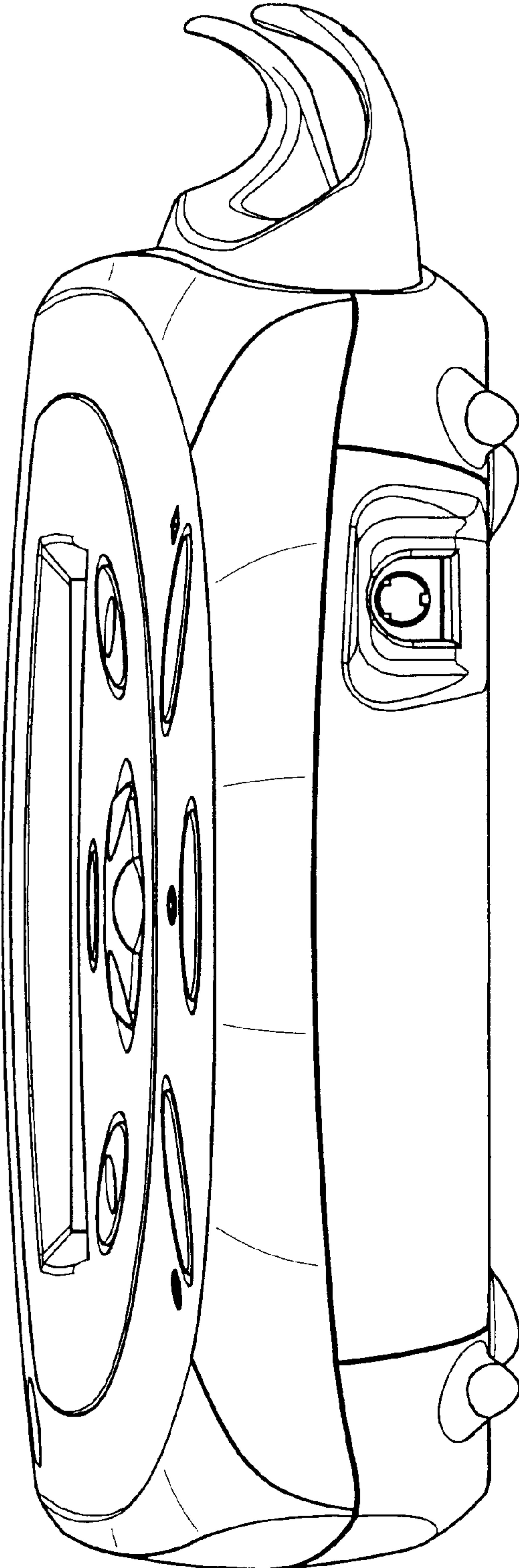

FIGURE 2

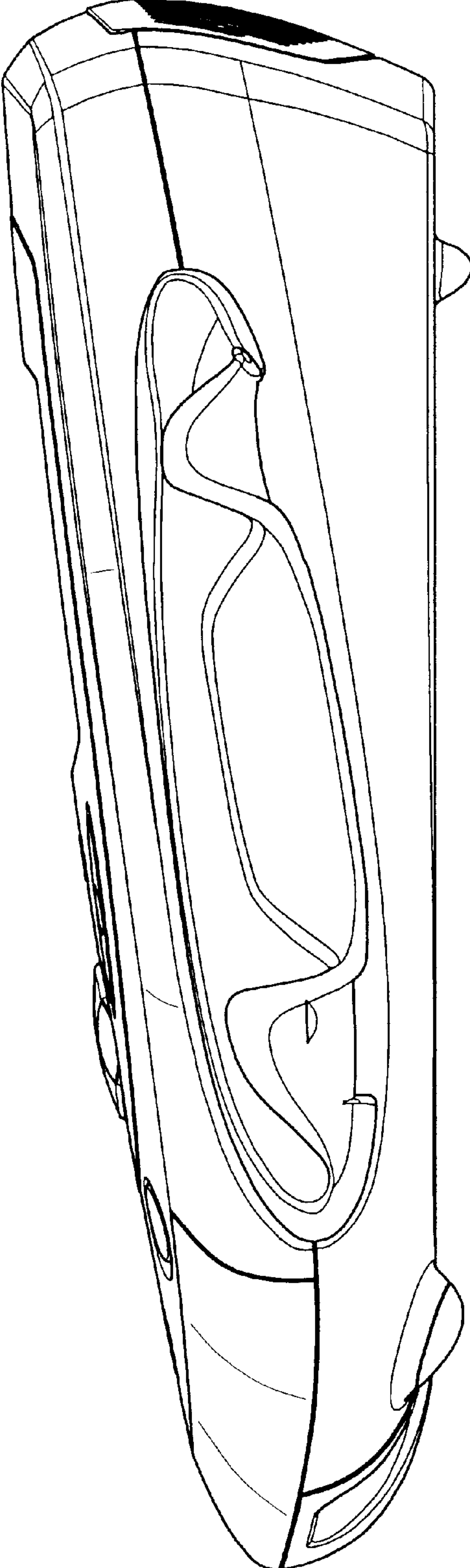

FIGURE 3



FIGURE 4

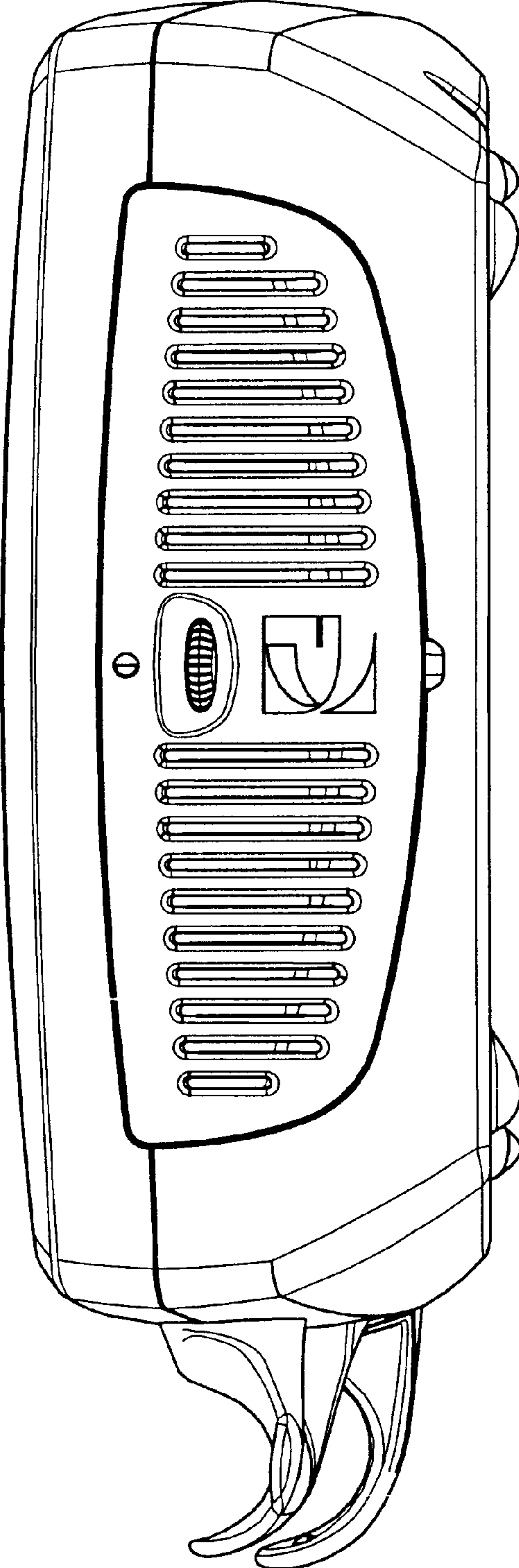

FIGURE 5

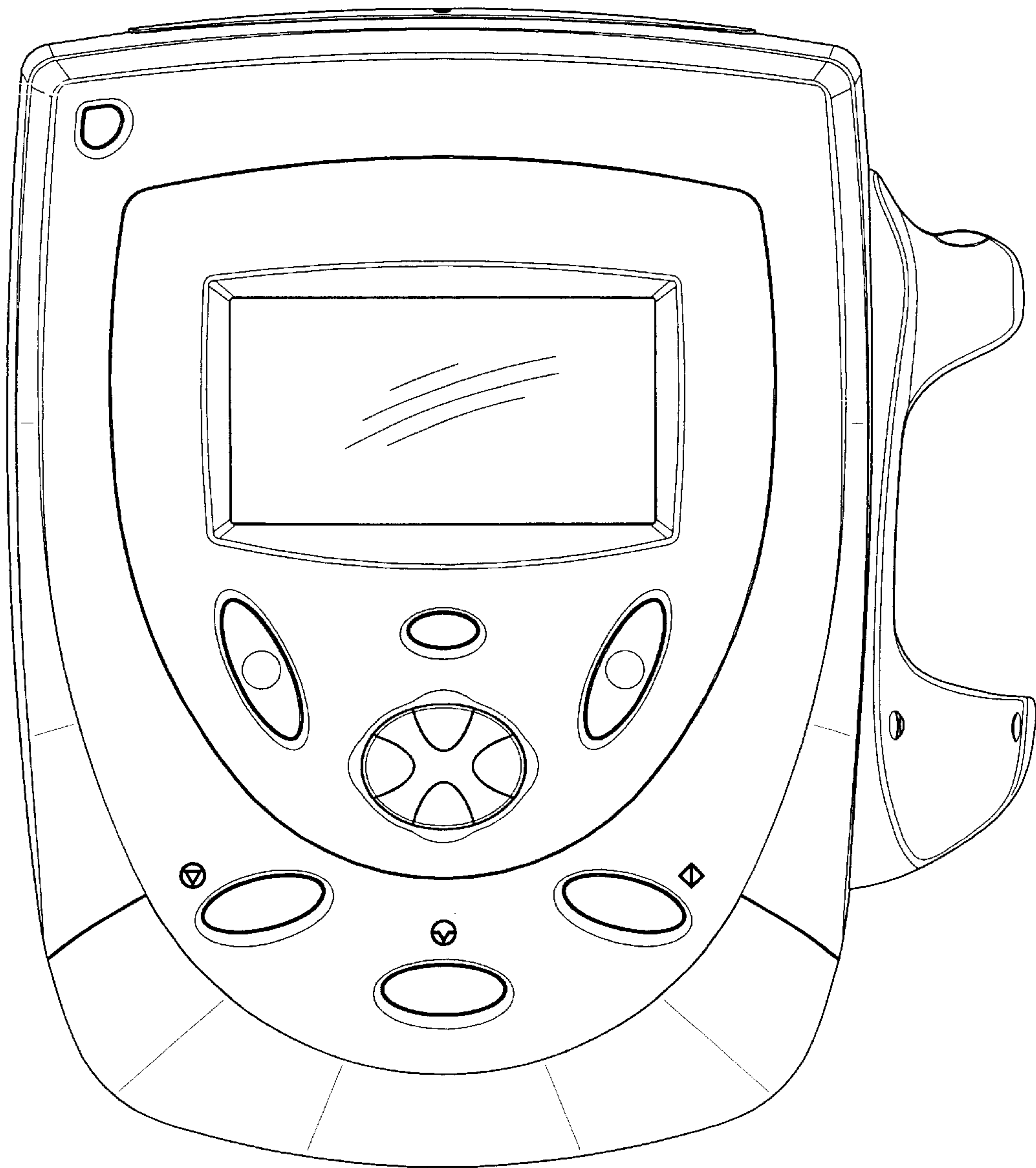

FIGURE 6

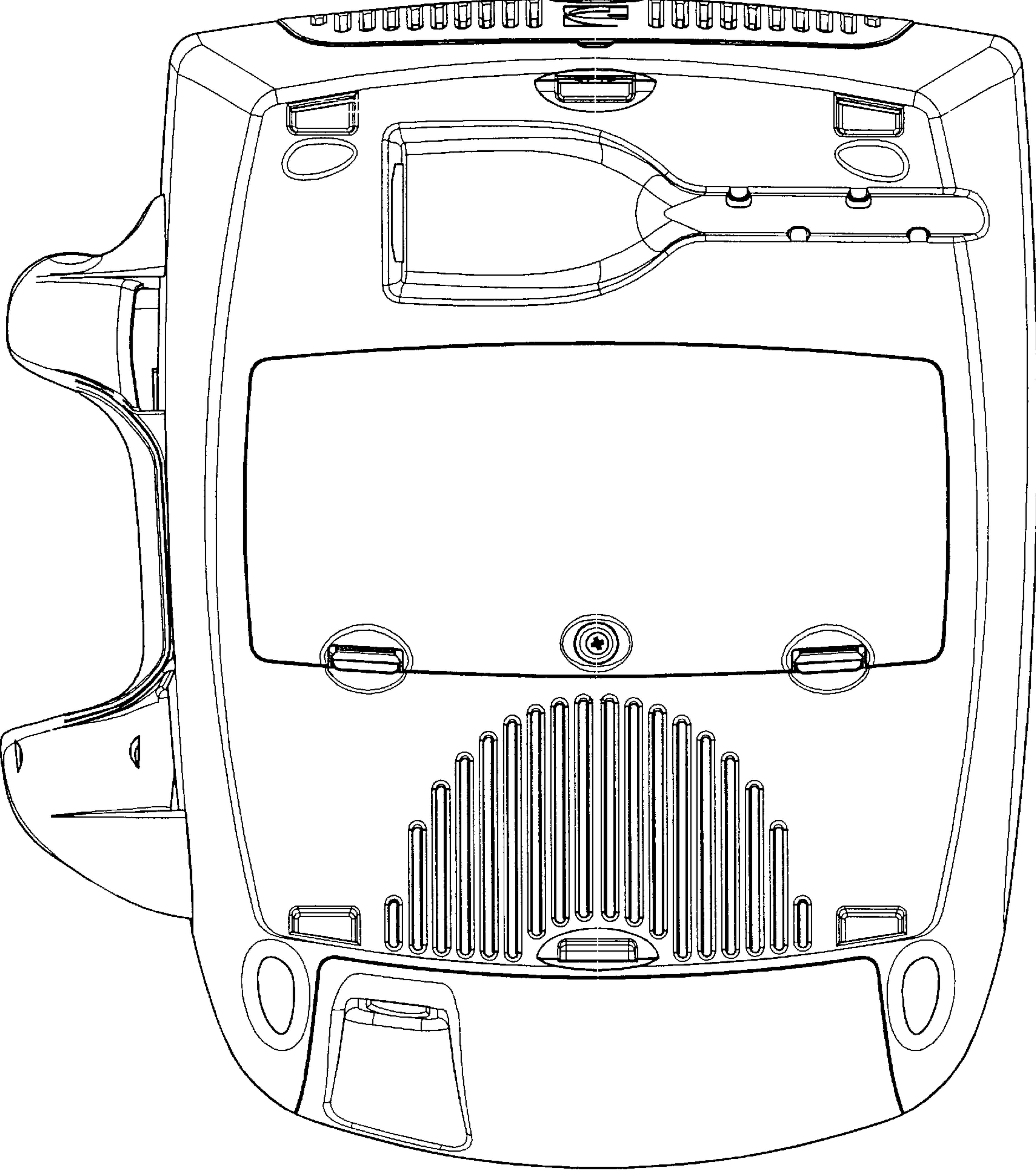

FIGURE 7