

US00D505682S

(12) **United States Design Patent** (10) **Patent No.:** **US D505,682 S**  
**Hisamitsu** (45) **Date of Patent:** **\*\* May 31, 2005**

(54) **SCREEN FOR A GRAIN MILLING MACHINE**

*Primary Examiner*—Mitchell Siegel  
(74) *Attorney, Agent, or Firm*—Nixon Peabody LLP;  
Donald R. Studebaker

(75) **Inventor:** **Yasushi Hisamitsu**, Tokyo (JP)

(73) **Assignee:** **Satake Corporation**, Tokyo (JP)

(57) **CLAIM**

(\*\*) **Term:** **14 Years**

The ornamental design for a screen for a grain milling machine, as shown and described.

(21) **Appl. No.:** **29/186,218**

**DESCRIPTION**

(22) **Filed:** **Jul. 14, 2003**

(30) **Foreign Application Priority Data**

Jan. 15, 2003 (JP) ..... 2003-000681

(51) **LOC (7) Cl.** ..... **15-03**

(52) **U.S. Cl.** ..... **D15/28**

(58) **Field of Search** ..... D15/28; 99/617,  
99/600, 488, 544, 547, 549, 560, 519, 523,  
524, 528

FIG. 1 is a front view of a screen for a grain milling machine according the present design;  
FIG. 2 is a rear view of FIG. 1;  
FIG. 3 is a top plan view of FIG. 1;  
FIG. 4 is a bottom plan view of FIG. 1;  
FIG. 5 is a right side view of FIG. 1;  
FIG. 6 is a sectional view of the screen taken along line 6—6 in FIG. 7;  
FIG. 7 is a reference view similar to the view of FIG. 1, but indicating lines 6—6 and 8—8 along which sections are to be taken, and square line 9 by which a portion is to be enlarged;  
FIG. 8 is an enlarged sectional view of the screen taken along line 8—8 in FIG. 7;  
FIG. 9 is an enlarged view of the portion surrounded by square line 9 in FIG. 7;  
FIG. 10 is a reference view in vertical section showing how the screen is utilized in a grain milling machine; and,  
FIG. 11 is a reference view in cross-section similar to FIG. 10.

(56) **References Cited**

**U.S. PATENT DOCUMENTS**

1,221,855	A *	4/1917	Hicks	99/617
1,624,831	A *	4/1927	Geddes	99/488
2,360,411	A *	10/1944	Giovanni	99/544
3,628,582	A *	12/1971	Satake	99/617
5,394,792	A *	3/1995	Satake et al.	99/519

**FOREIGN PATENT DOCUMENTS**

JP	945887	11/1995
JP	945887	1/1996
JP	1049590	6/1996
JP	1049590	6/1999

The screen shown by broken lines is for illustrative purposes only and forms no part of the claimed design.

\* cited by examiner

**1 Claim, 7 Drawing Sheets**

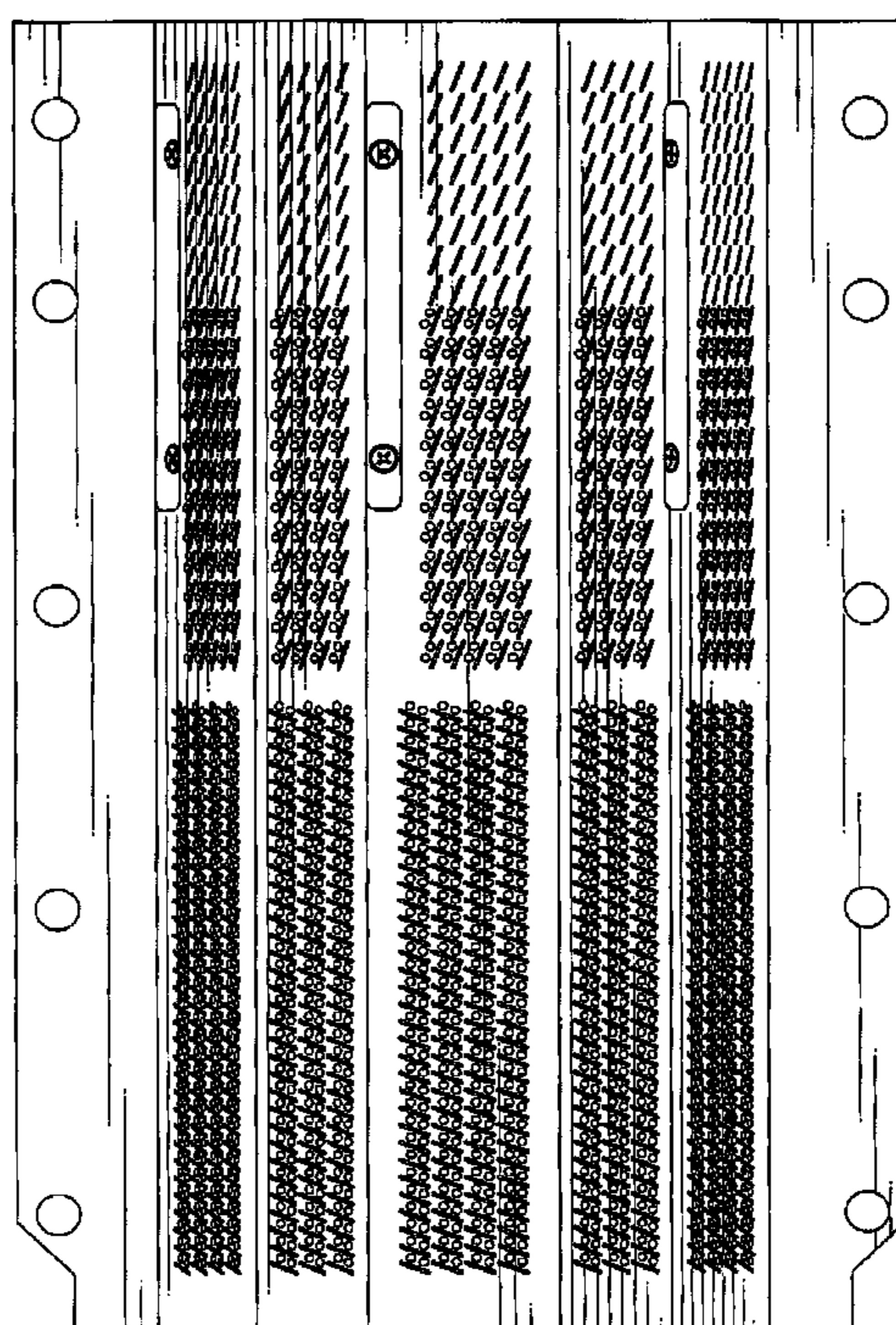

FIG. 1

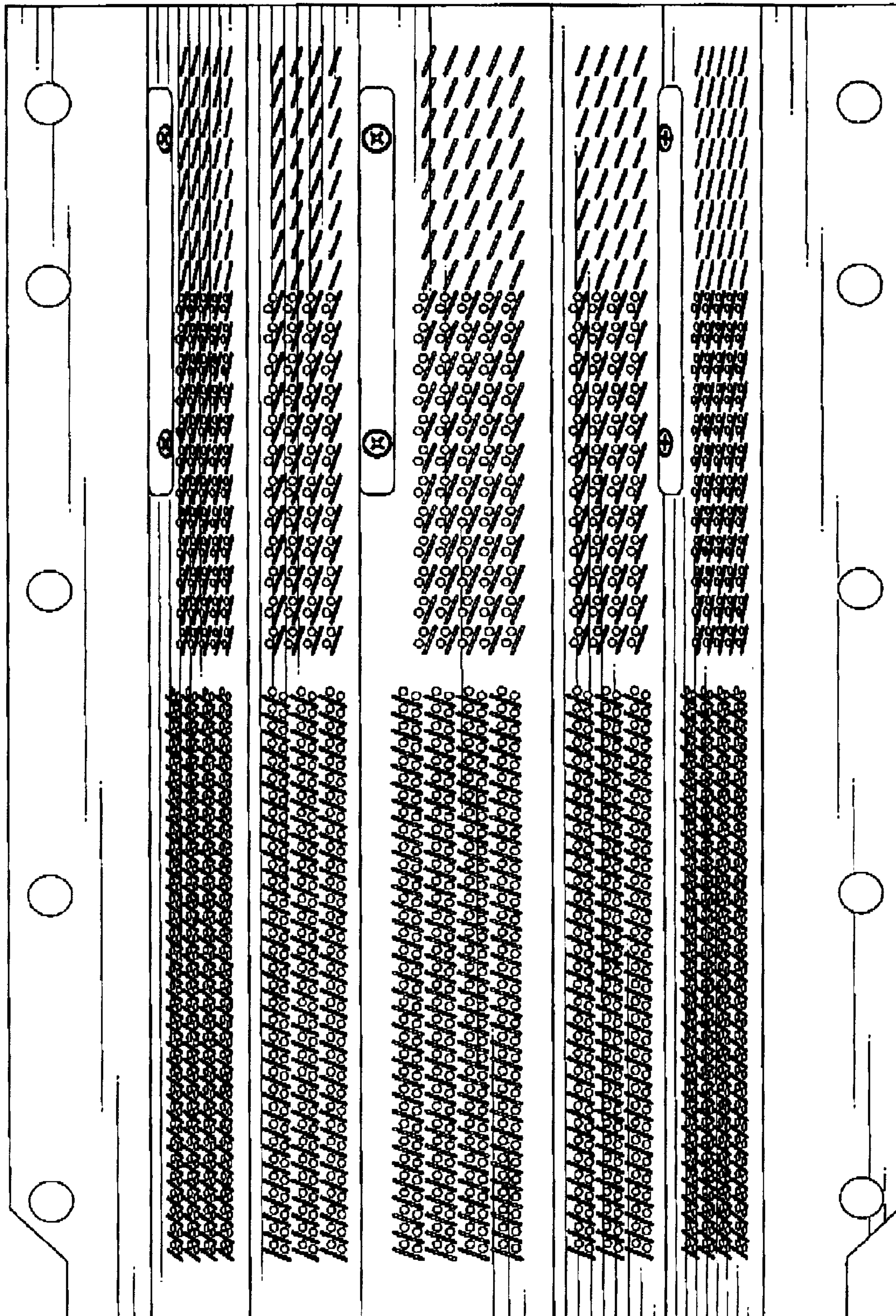
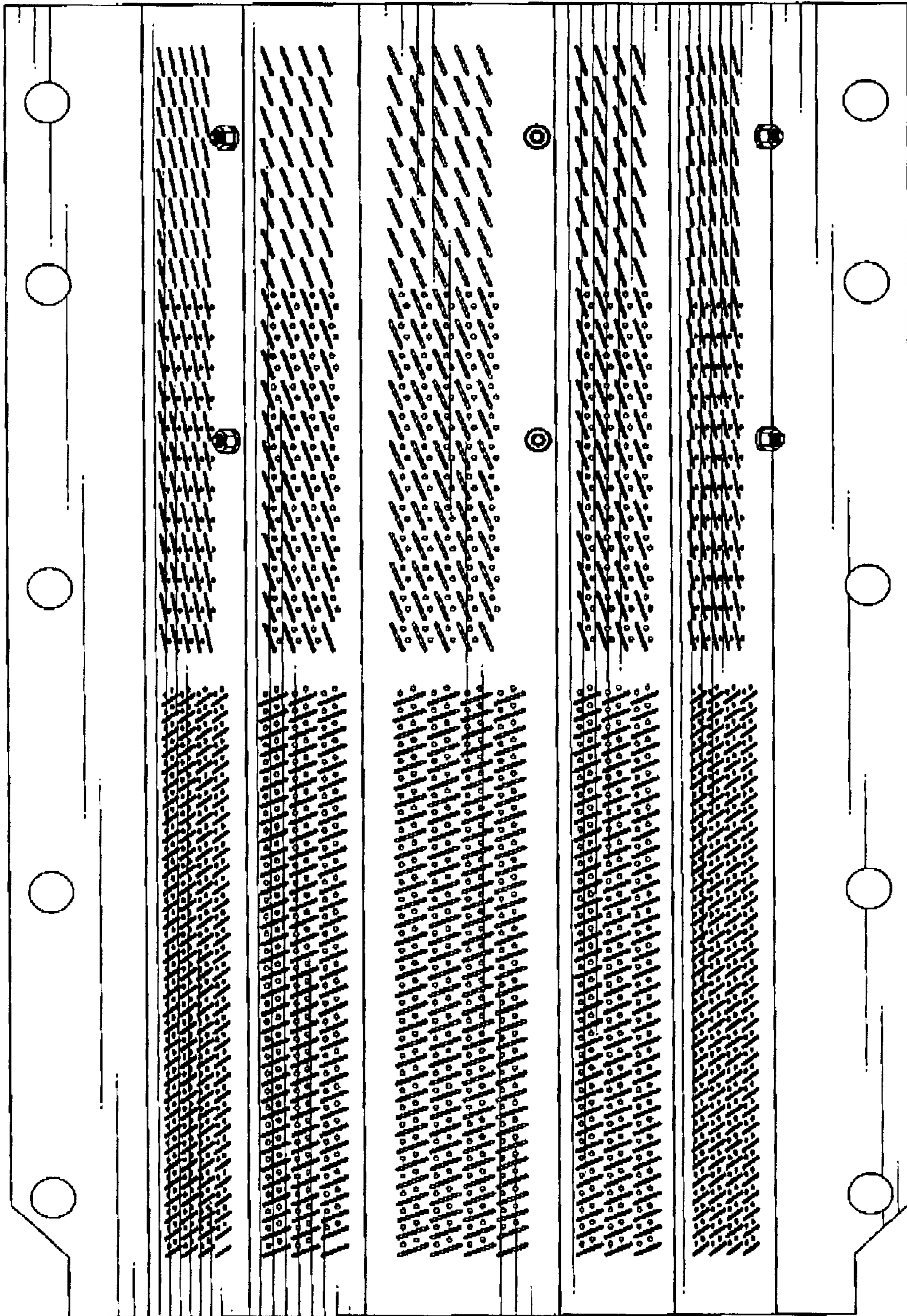
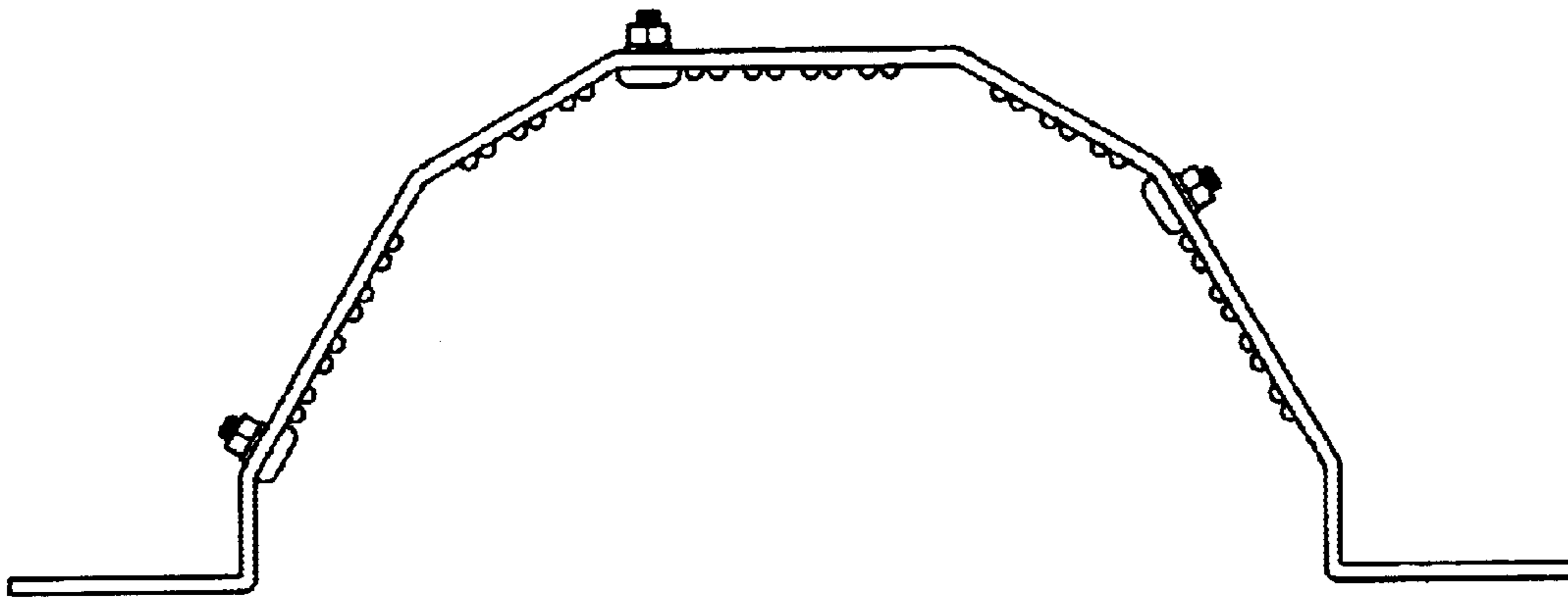

FIG. 2



**FIG. 3**



**FIG. 4**

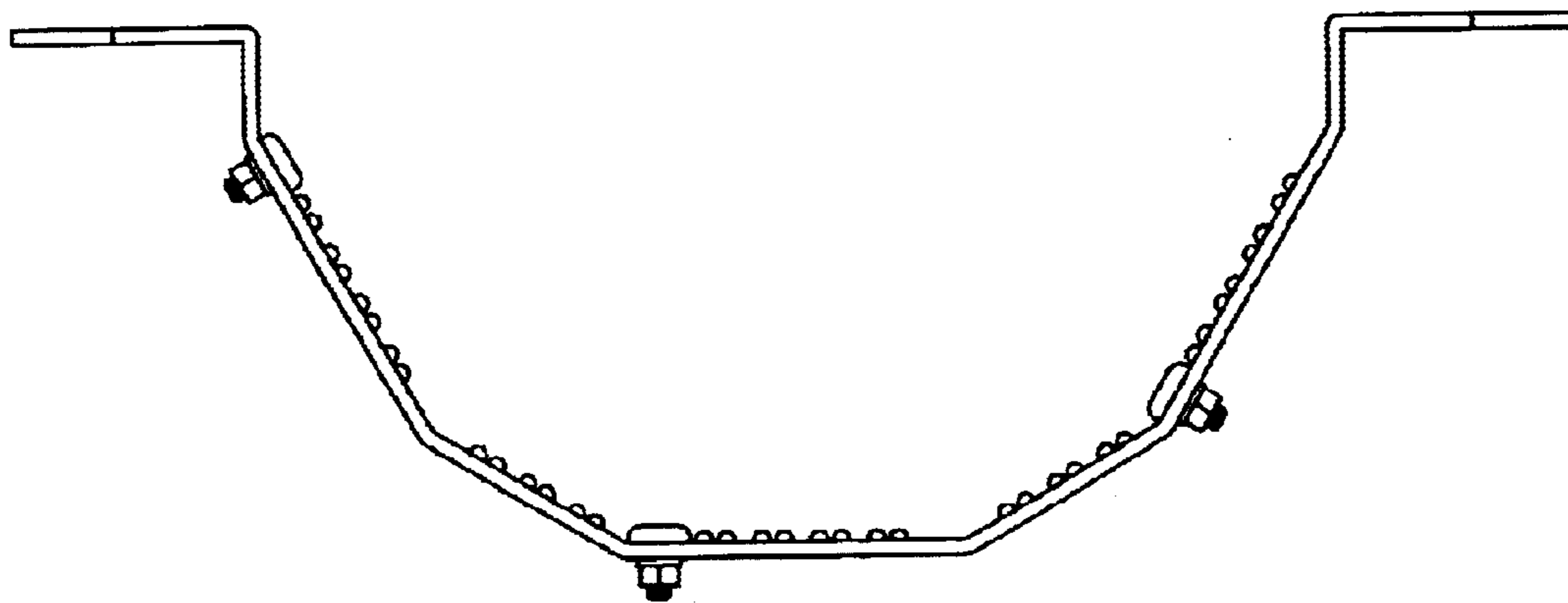

FIG. 5

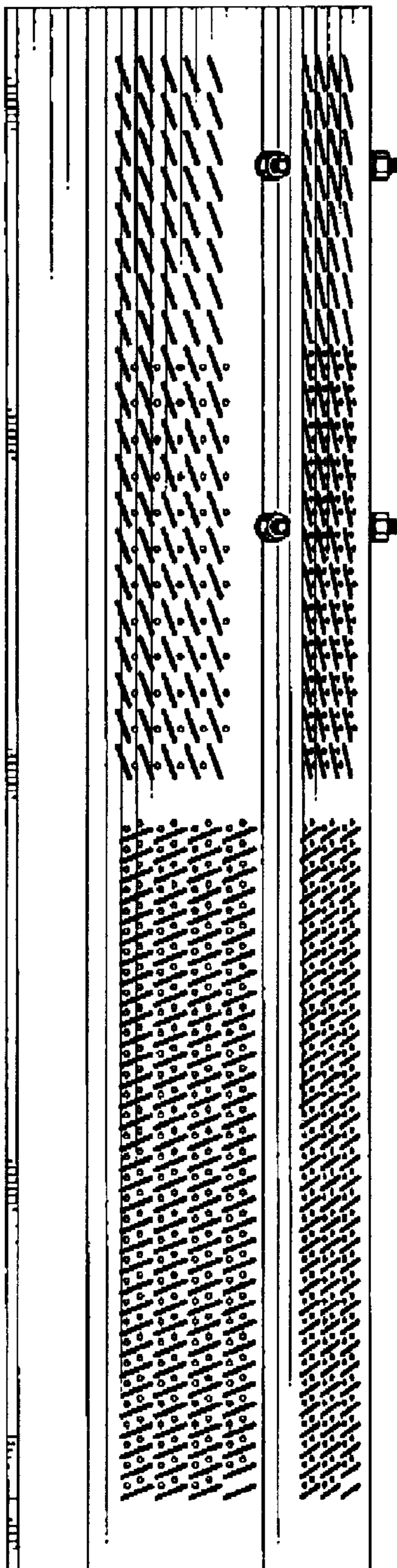

FIG. 6

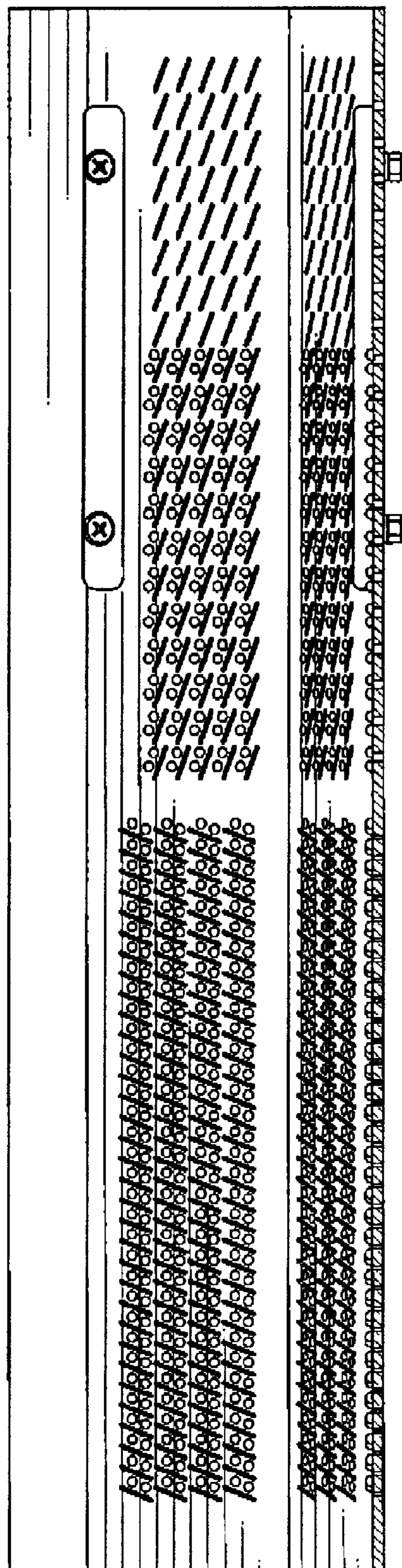

FIG. 7

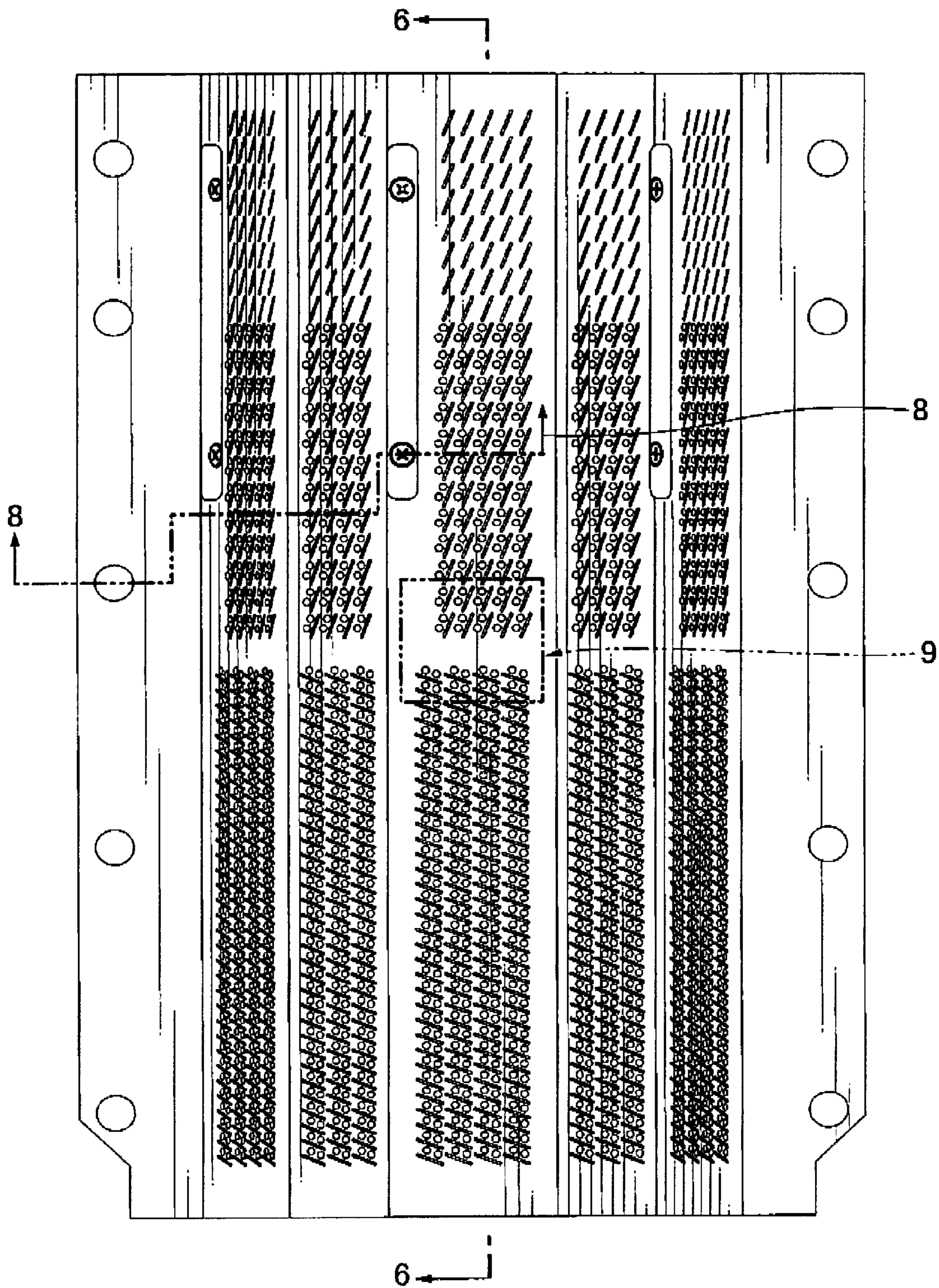

FIG. 8

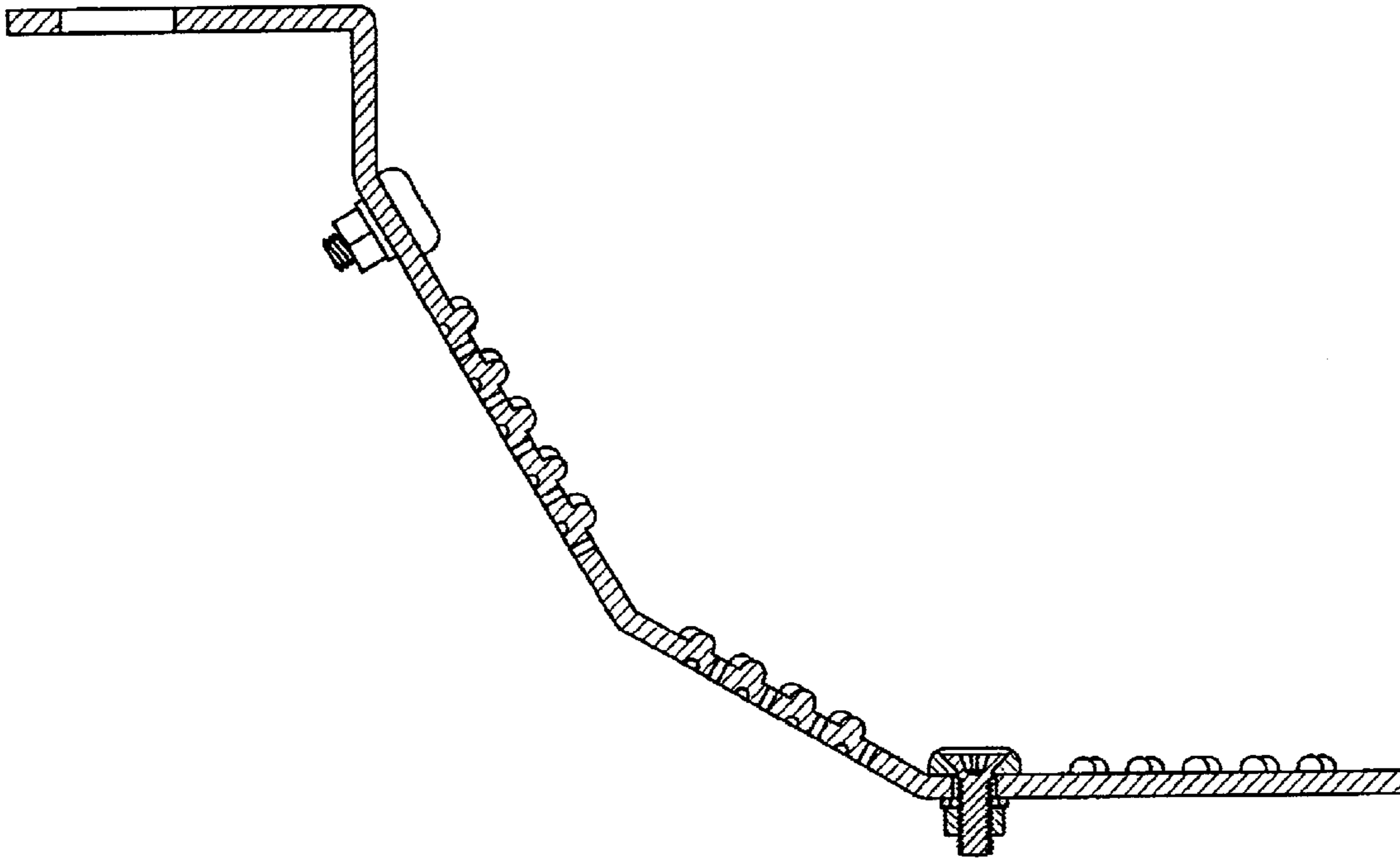

FIG. 9

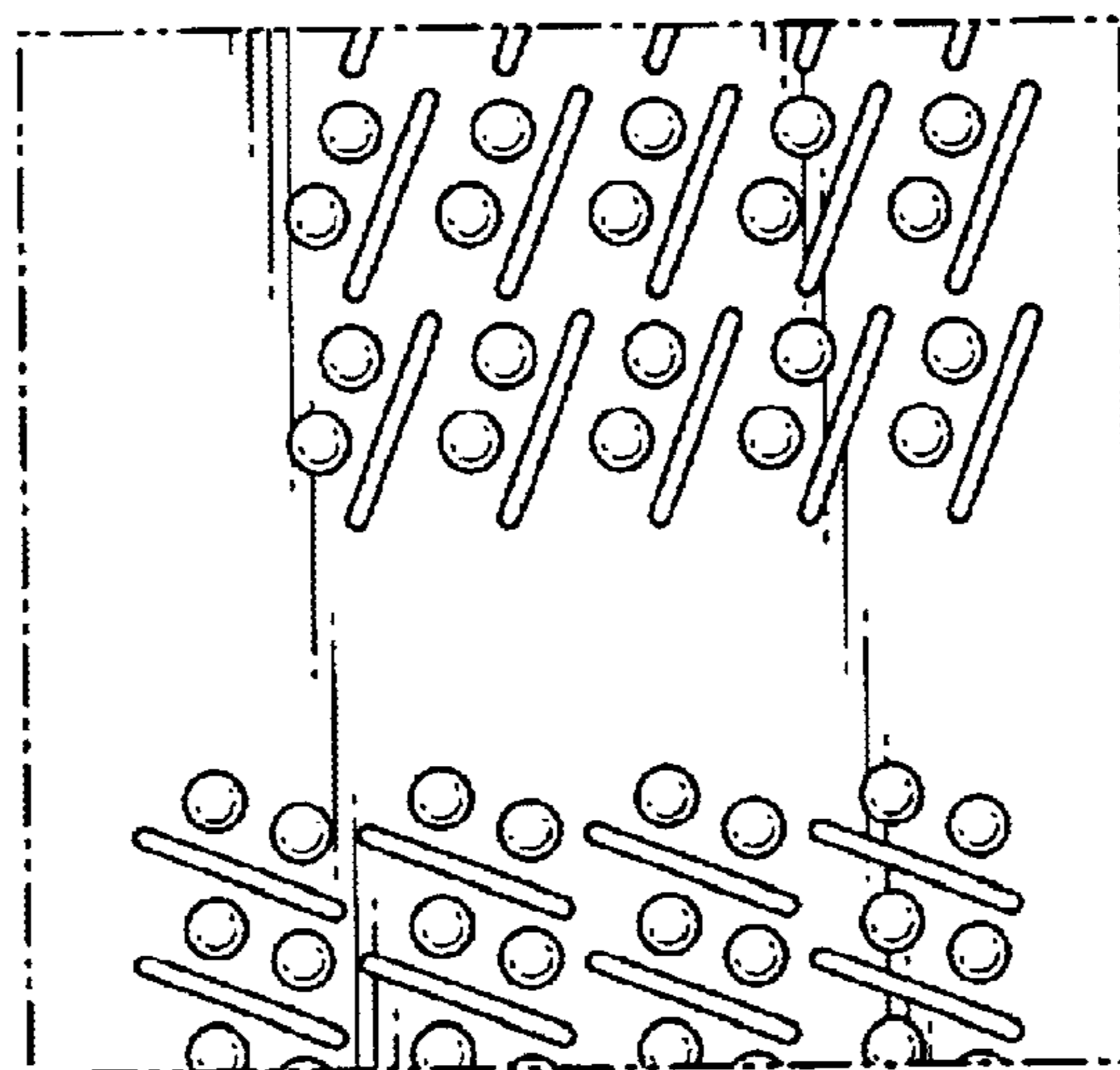

FIG. 10

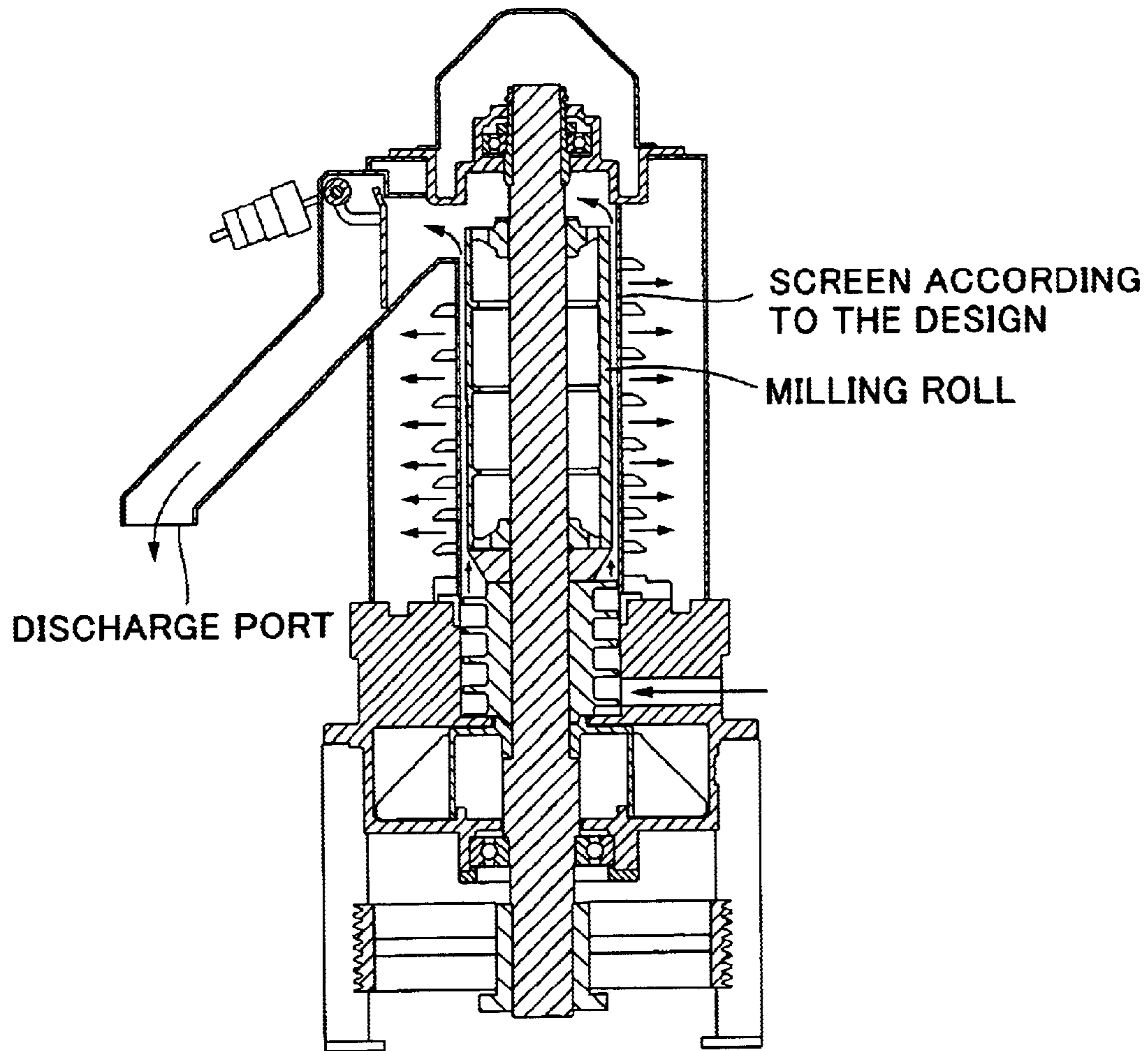

FIG. 11

