



US00D505602S

(12) **United States Design Patent**  
**Houghton**

(10) **Patent No.:** **US D505,602 S**

(45) **Date of Patent:** **\*\* May 31, 2005**

(54) **HEDGE TRIMMER**

(75) Inventor: **Stephen Houghton**, High West Jesmod  
(GB)

(73) Assignee: **Black & Decker, Inc.**, Newark, DE  
(US)

(\*\*) Term: **14 Years**

(21) Appl. No.: **29/181,510**

(22) Filed: **May 12, 2003**

(30) **Foreign Application Priority Data**

Nov. 14, 2002 (GB) ..... 3008638

(51) **LOC (7) Cl.** ..... **08-05**

(52) **U.S. Cl.** ..... **D8/8**

(58) **Field of Search** ..... D8/8; 30/208-210,  
30/228

(56) **References Cited**

**U.S. PATENT DOCUMENTS**

D376,740 S	*	12/1996	Gildersleeve	.....	D8/8
D462,882 S	*	9/2002	Evans	.....	D8/8
D463,228 S	*	9/2002	Cooper	.....	D8/8
D463,229 S	*	9/2002	Gabriel	.....	D8/8
D468,600 S	*	1/2003	Evans	.....	D8/8

**FOREIGN PATENT DOCUMENTS**

GB 2089337 \* 2/2000

\* cited by examiner

*Primary Examiner*—Holly Baynham

(74) *Attorney, Agent, or Firm*—Paul L. Ratcliffe; John Yun;  
Bruce S. Shapiro

(57) **CLAIM**

The ornamental design for a hedge trimmer, as shown and described.

**DESCRIPTION**

FIG. 1 is a front perspective view with the handle in forward position;

FIG. 2 is a rear perspective view with the handle in forward position;

FIG. 3 is a view from one side with the handle in forward position;

FIG. 4 is a view from other side with the handle in forward position;

FIG. 5 is a plan view with the handle in forward position;

FIG. 6 is an underneath view with the handle in forward position;

FIG. 7 is a front view with the handle in forward position;

FIG. 8 is a rear view with the handle in forward position;

FIG. 9 is a front perspective view with the handle in rear position;

FIG. 10 is a rear perspective view with the handle in rear position;

FIG. 11 is a view from one side with the handle in rear position;

FIG. 12 is a view from other side with the handle in rear position;

FIG. 13 is a plan view with the handle in rear position; and, FIG. 14 is underneath view with the handle in rear position; The blade has been removed from the drawing views of FIGS. 9-14 for clarity of illustration.

**1 Claim, 14 Drawing Sheets**

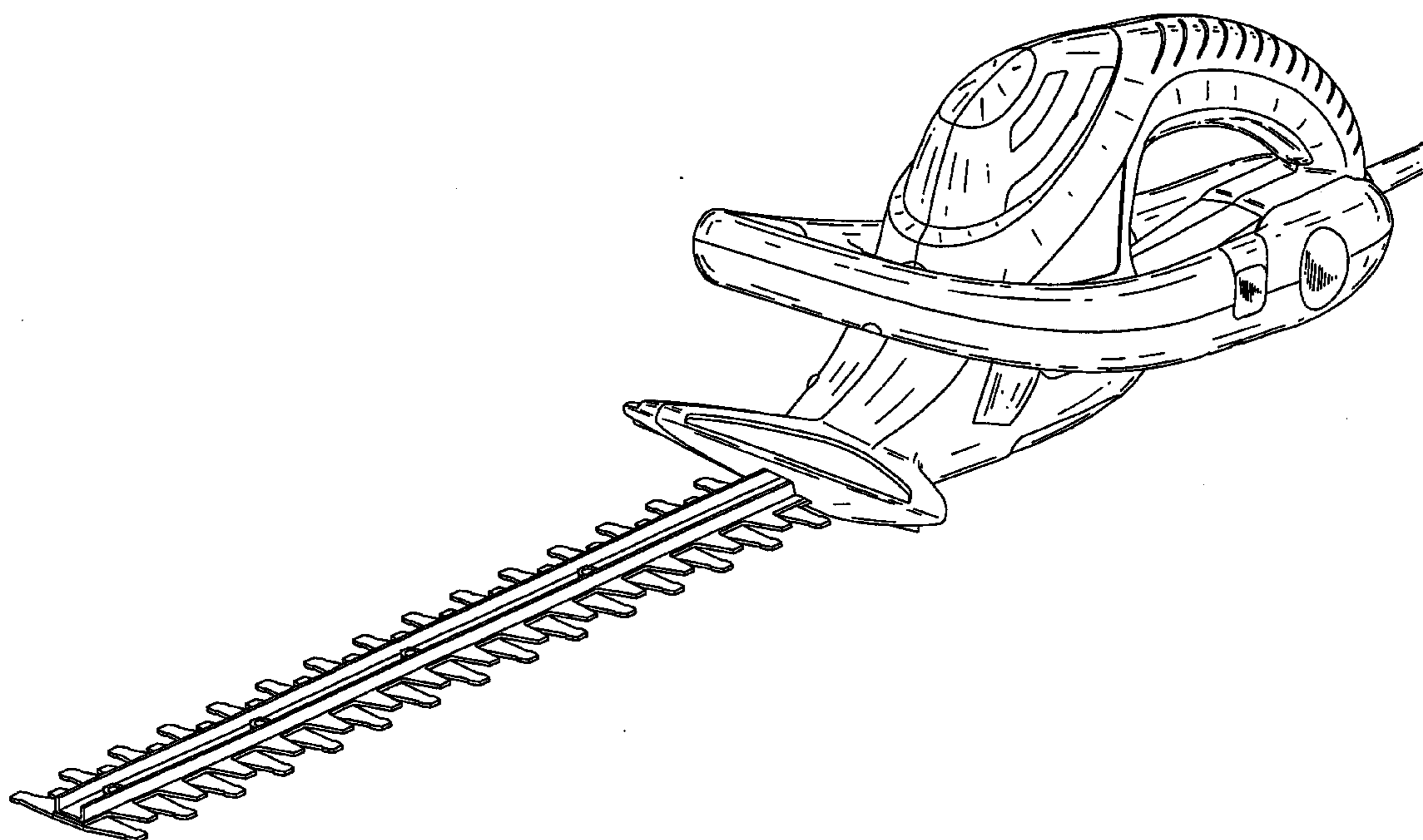

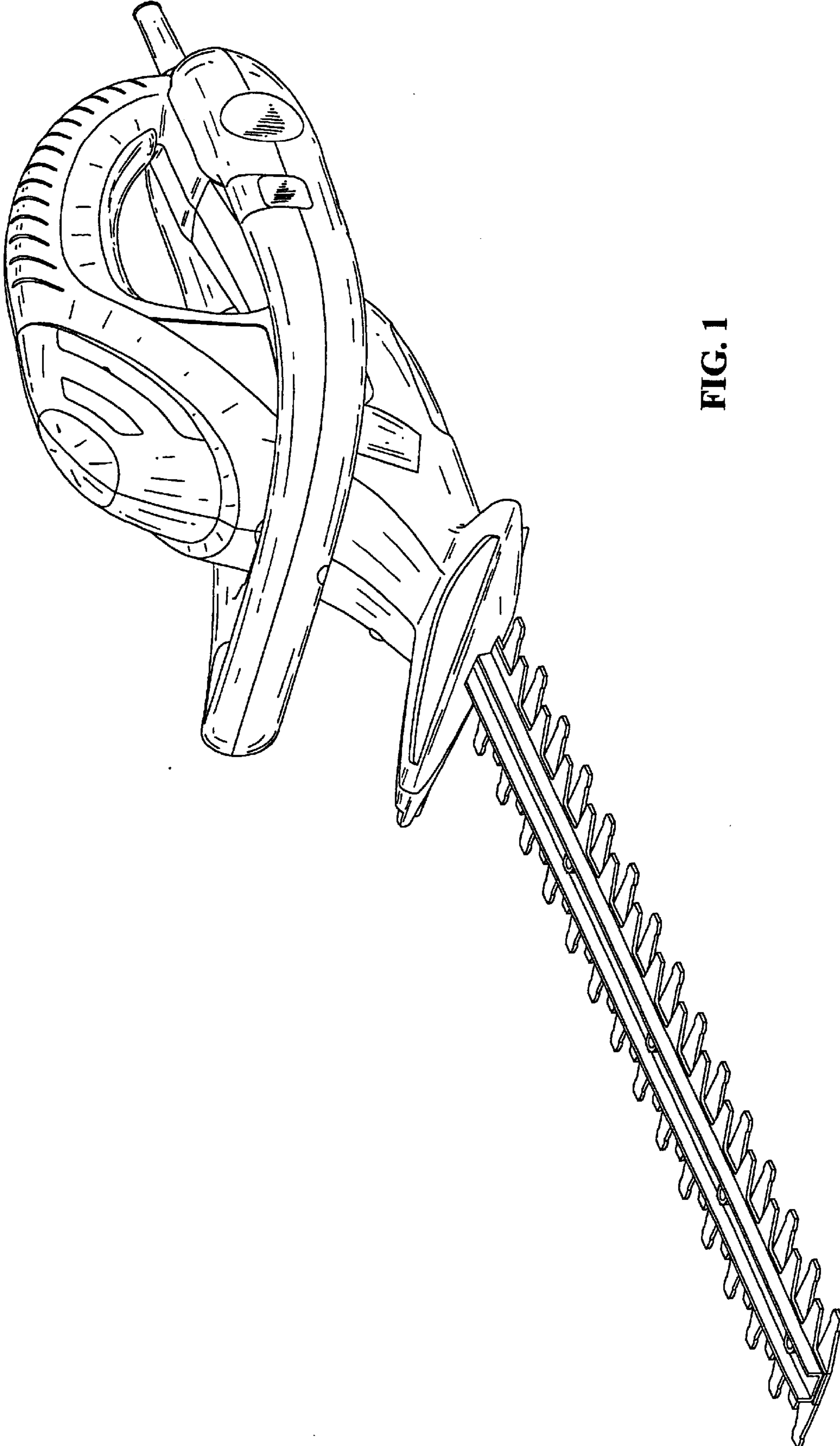

FIG. 1

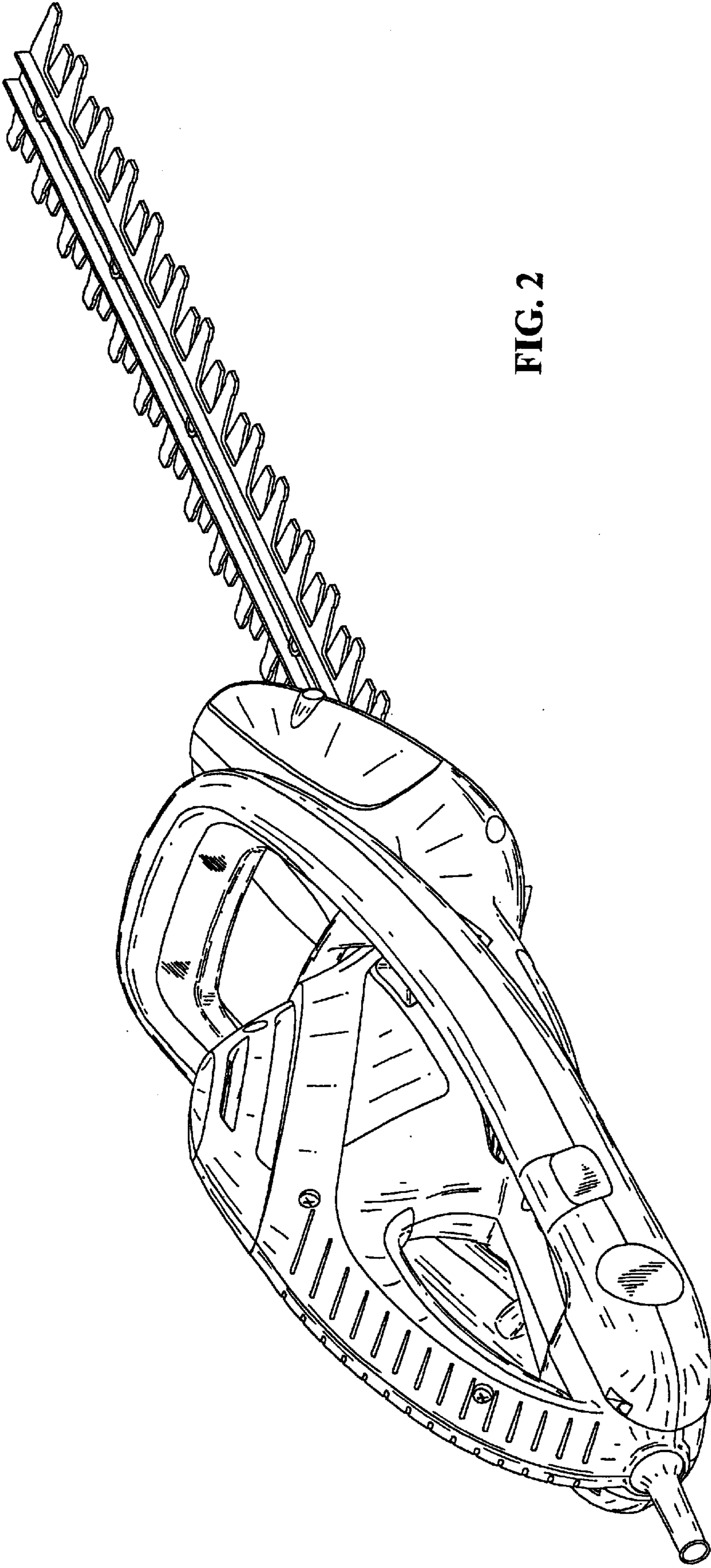

FIG. 2

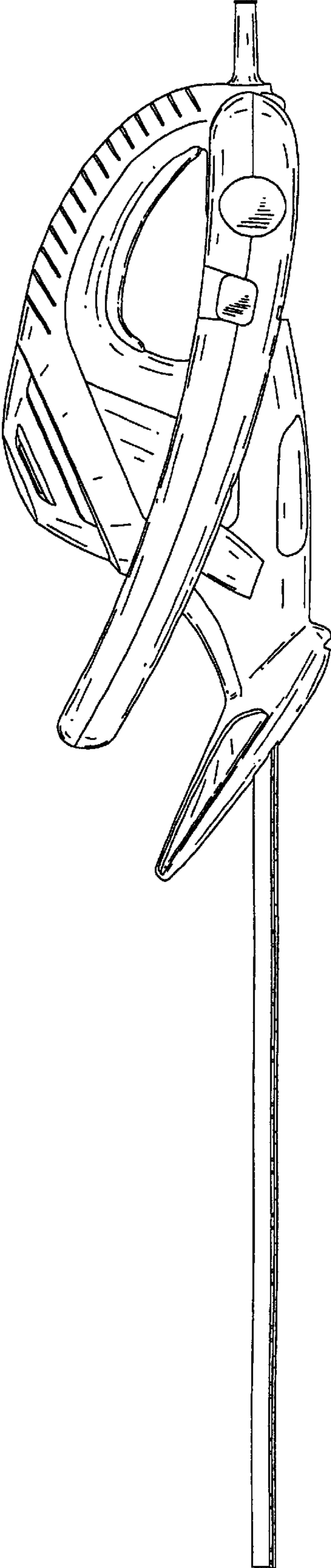

FIG. 3



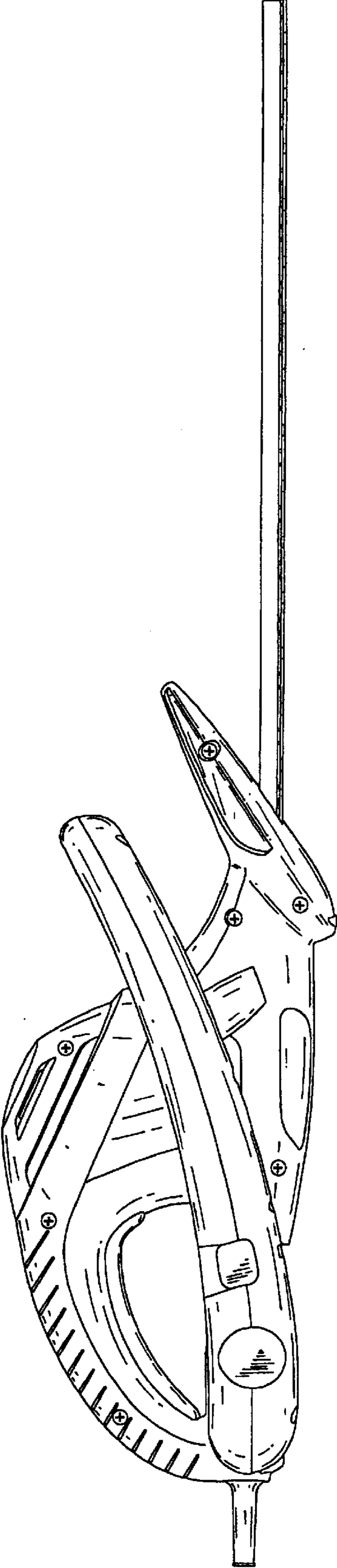

FIG. 4

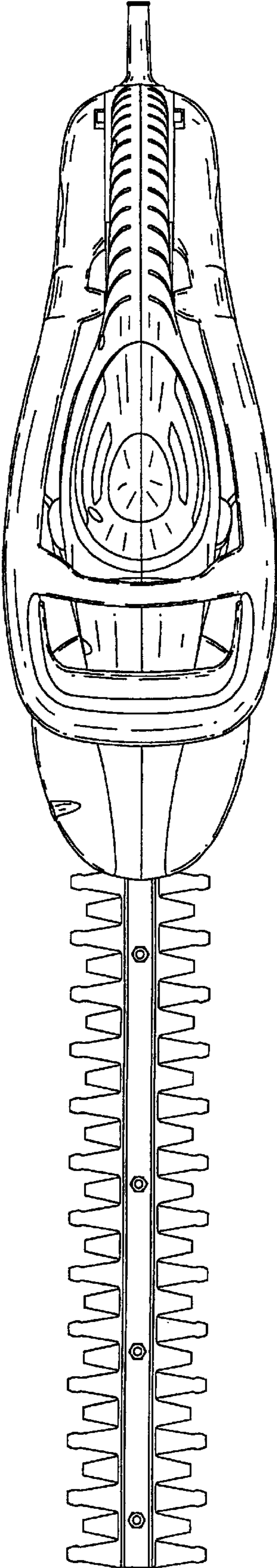

FIG. 5

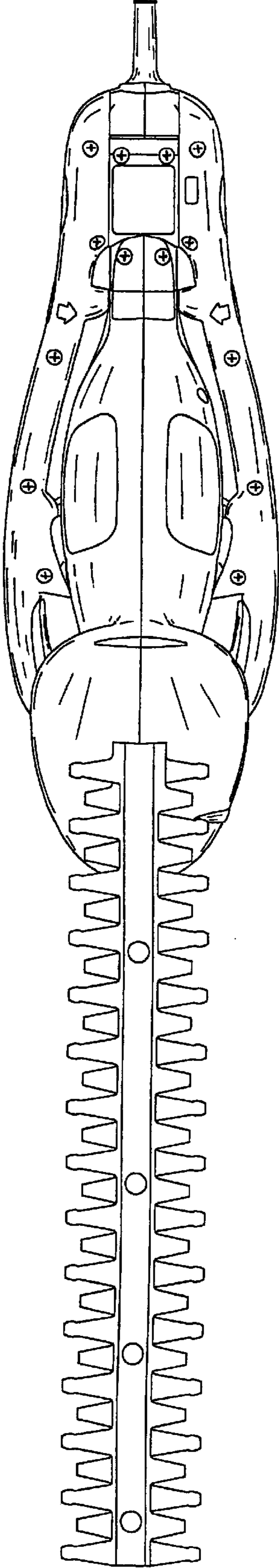

FIG. 6

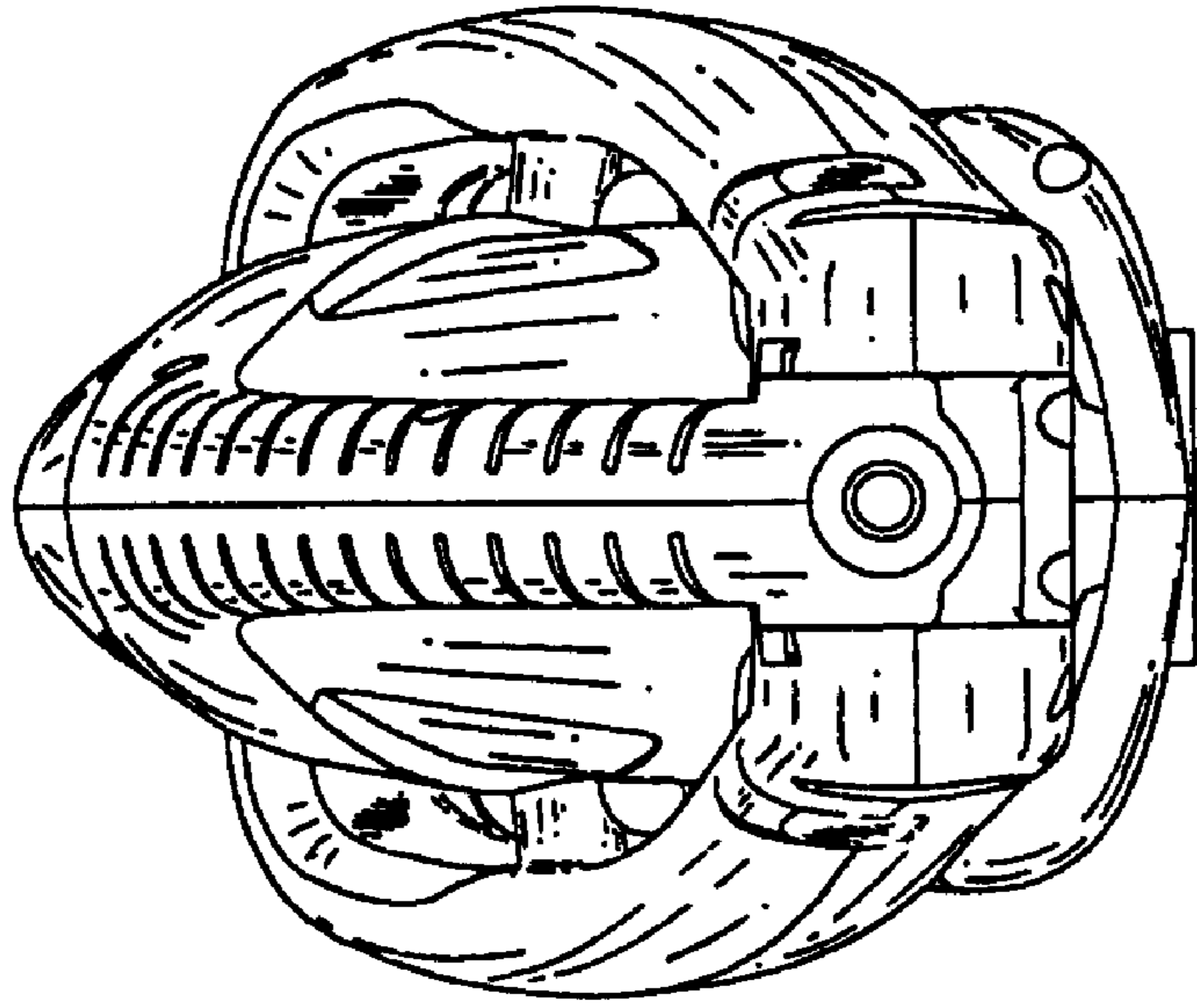

FIG. 8

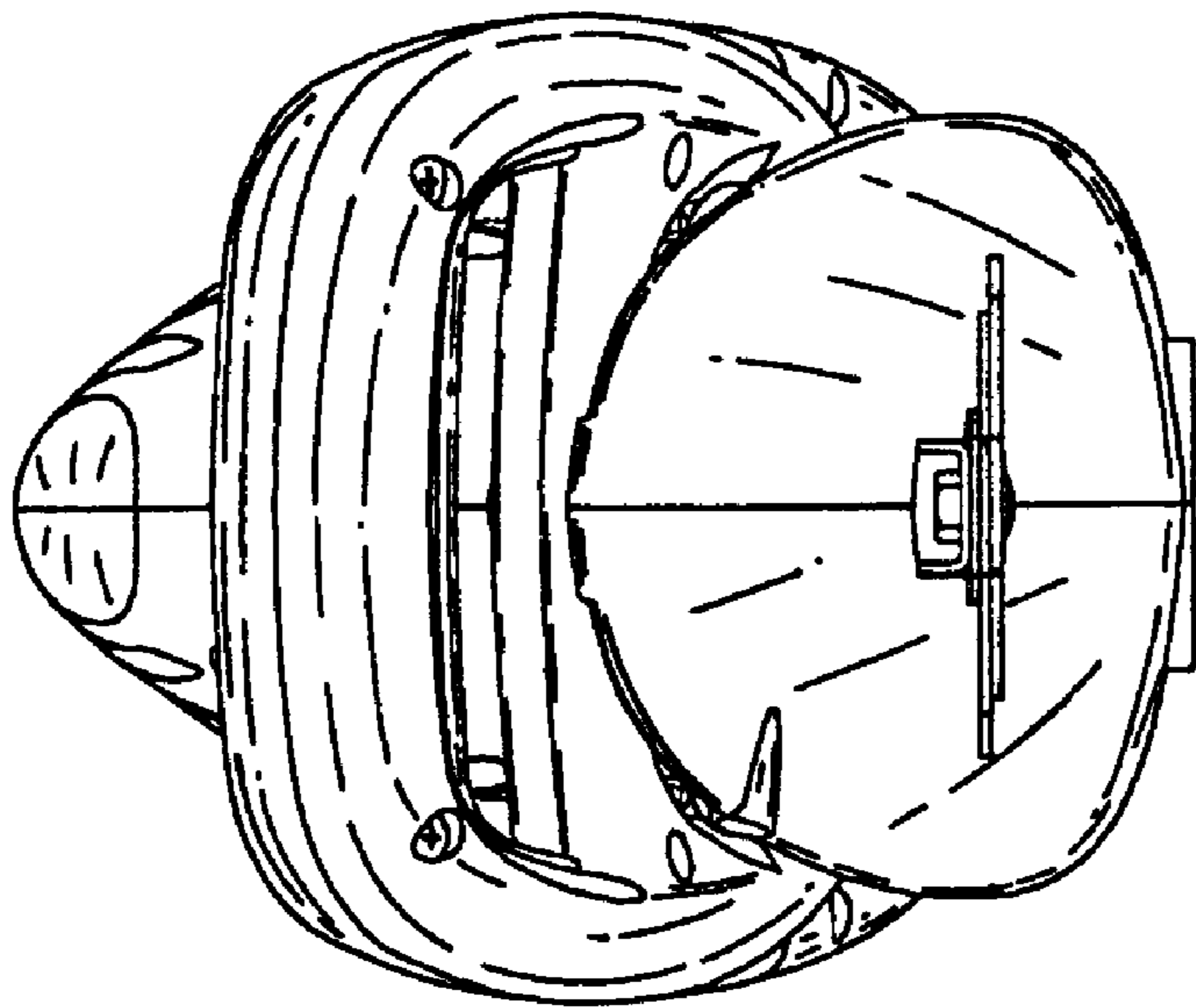

FIG. 7



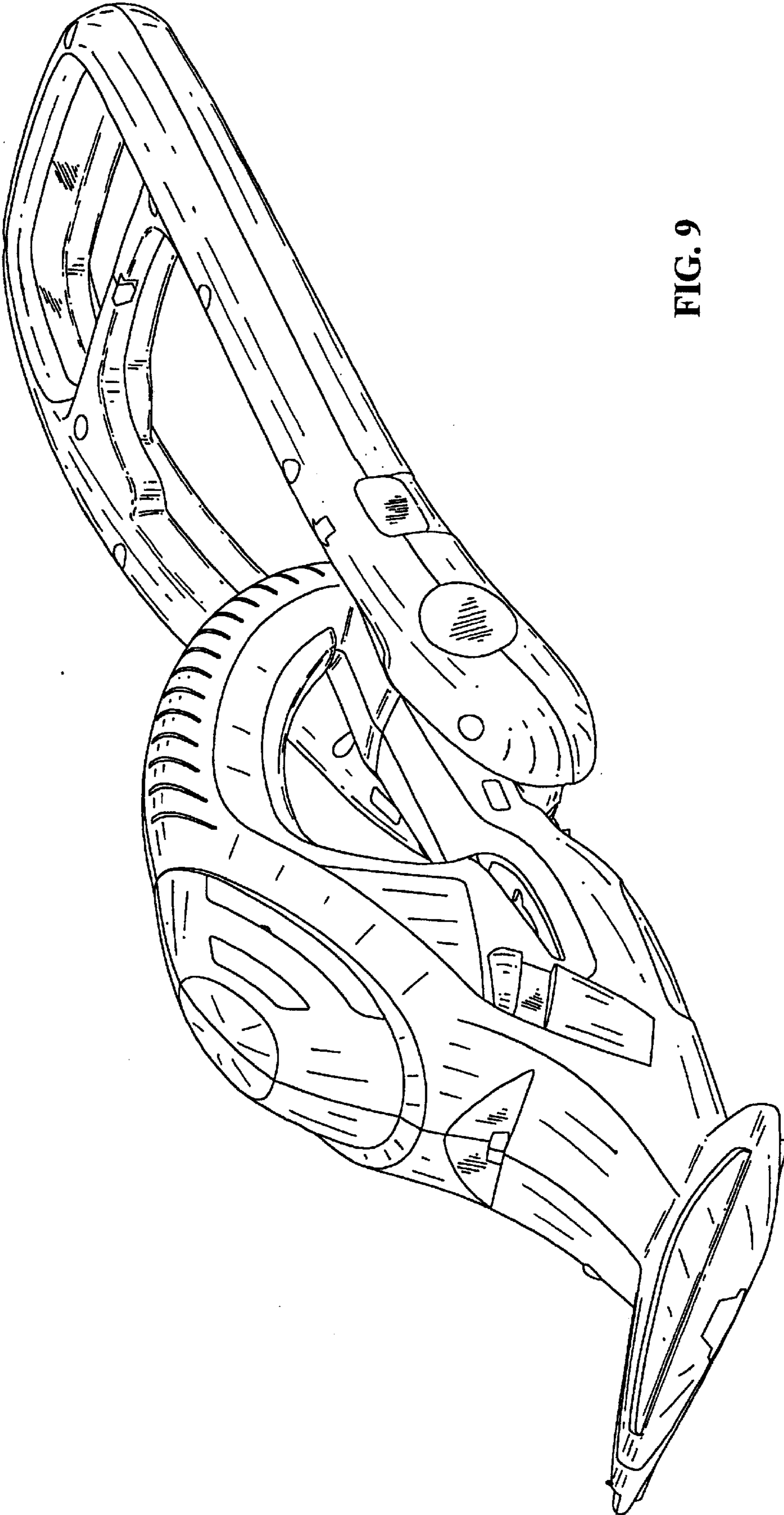

FIG. 9

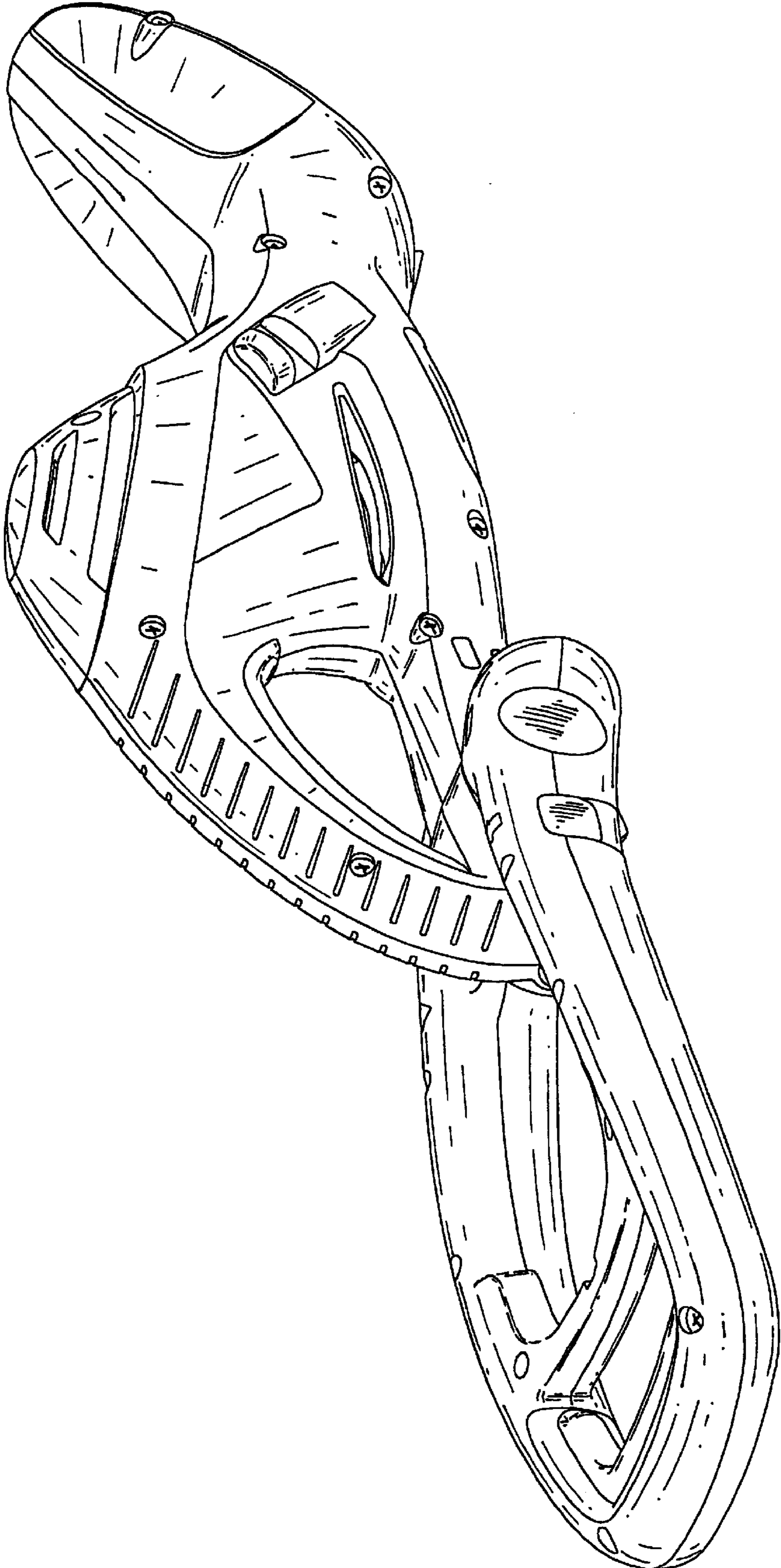

FIG. 10

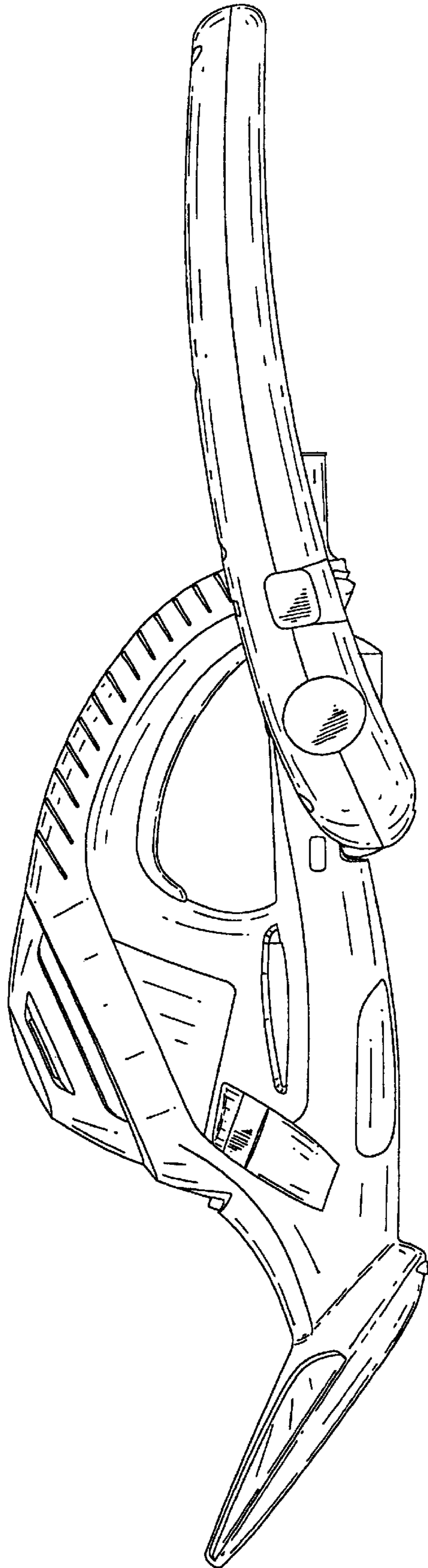

FIG.11

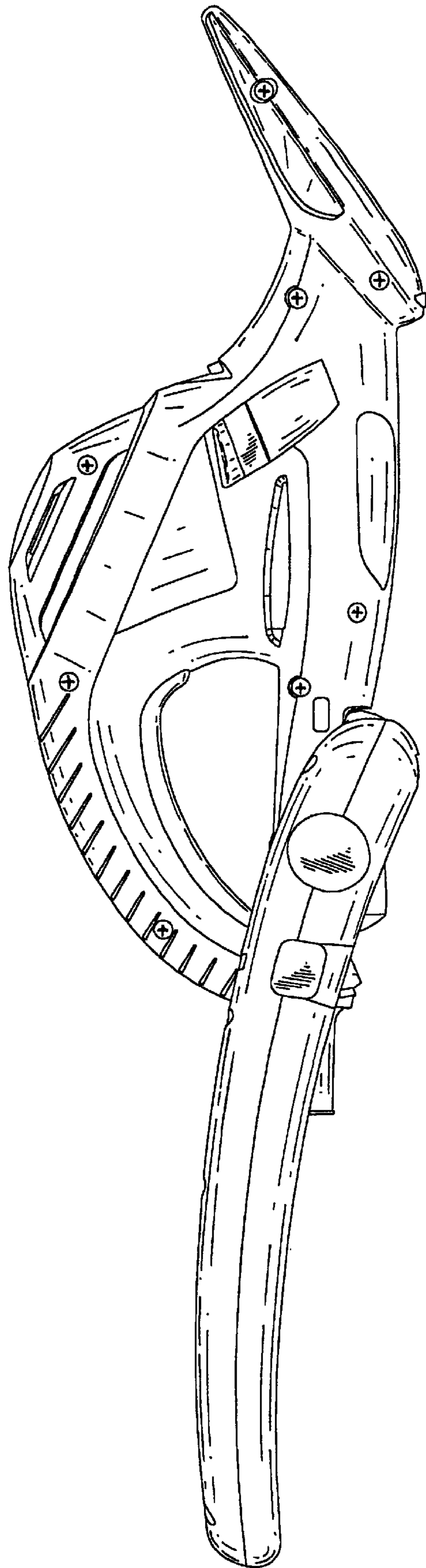

FIG.12

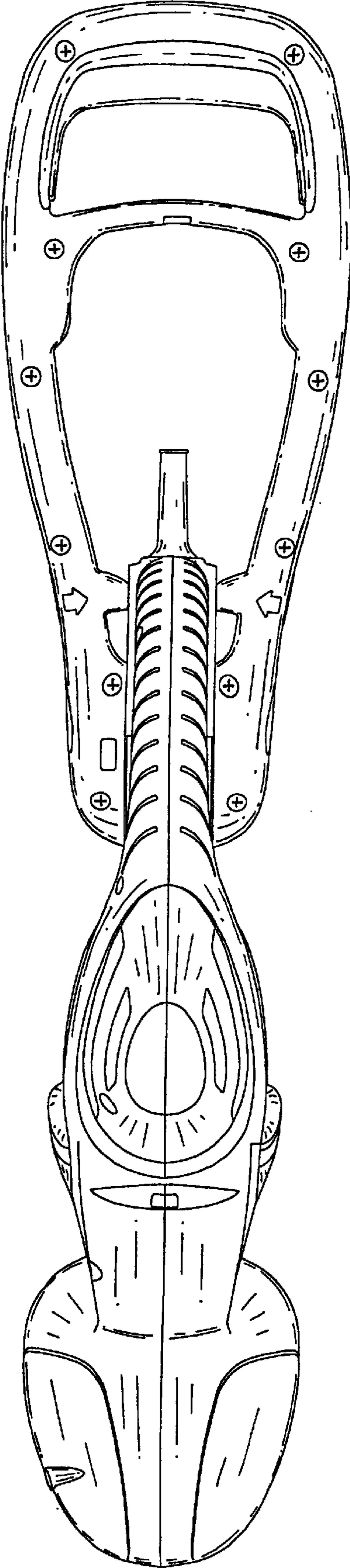

FIG.13



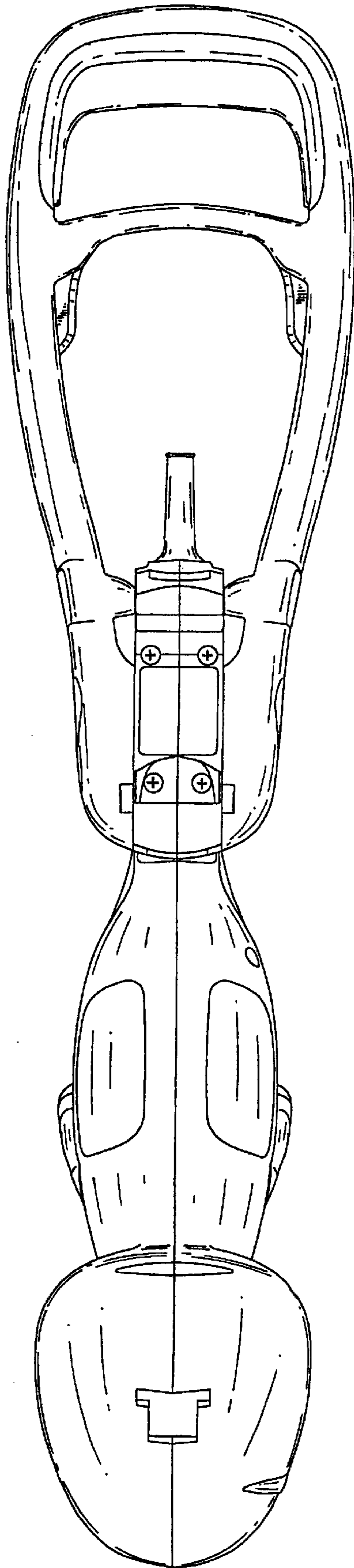

FIG.14

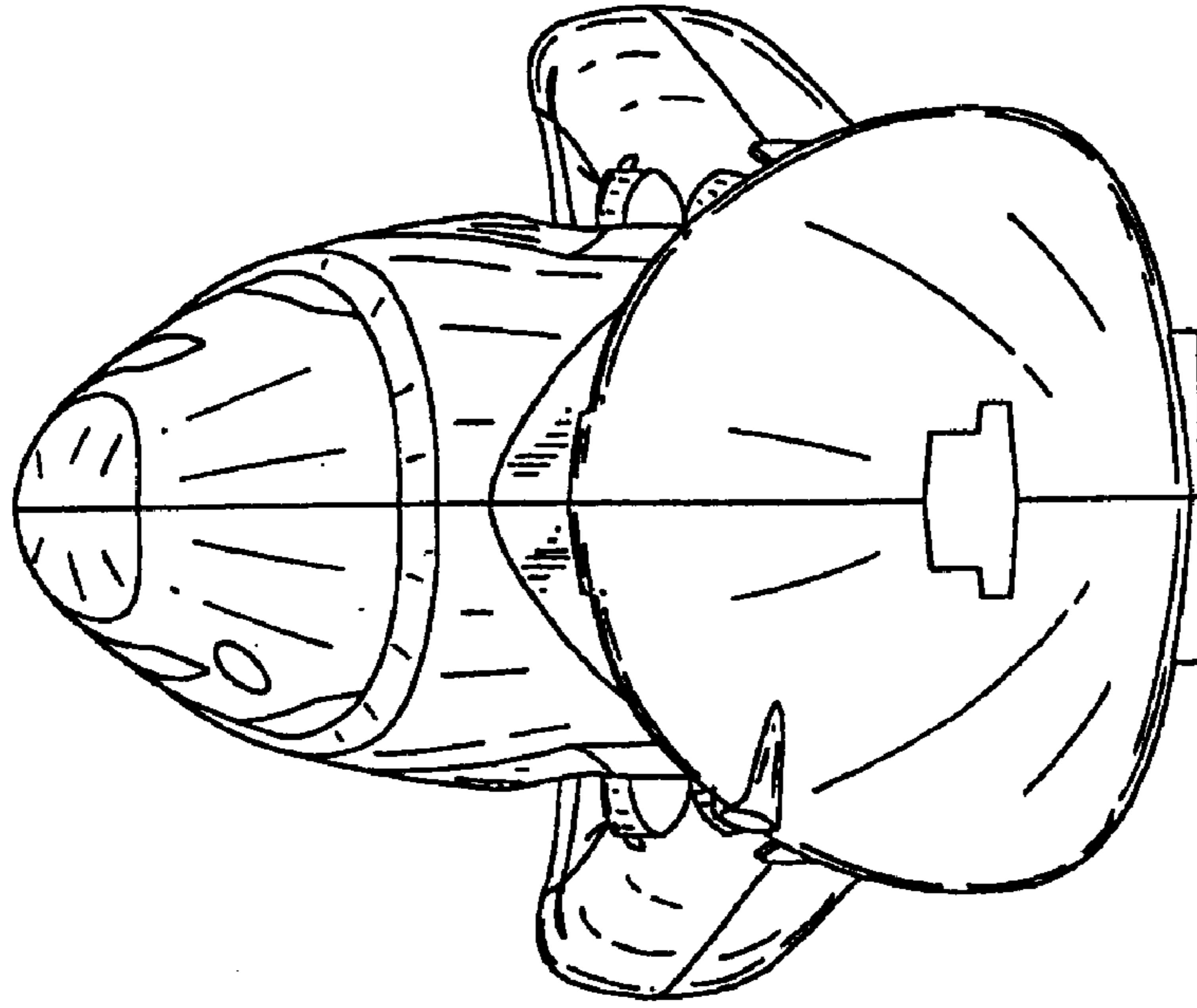

FIG.16

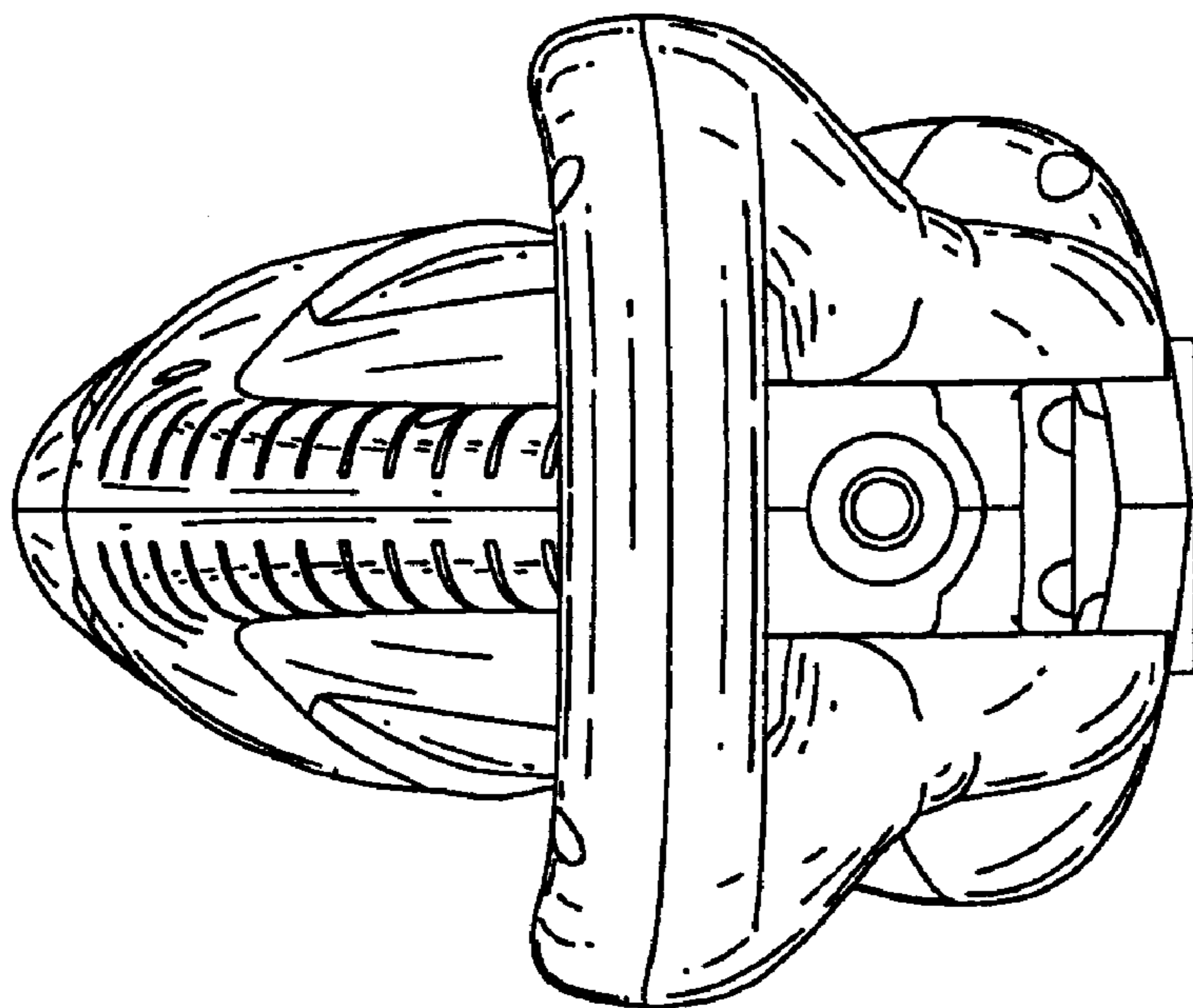

FIG.15