

US00D505580S

(12) **United States Design Patent**
Mohundro

(10) **Patent No.:** **US D505,580 S**

(45) **Date of Patent:** **** *May 31, 2005**

(54) **BED FOOTBOARD**

D493,040 S * 7/2004 Wanek et al. D6/393

(75) **Inventor:** **James Glenn Mohundro, Taichung (TW)**

(73) **Assignee:** **Pacific Marketing International Co., Ltd., Taichung (TW)**

(*) **Notice:** This patent is subject to a terminal disclaimer.

(**) **Term:** **14 Years**

(21) **Appl. No.:** **29/192,138**

(22) **Filed:** **Oct. 21, 2003**

(51) **LOC (7) Cl.** **06-06**

(52) **U.S. Cl.** **D6/505**

(58) **Field of Search** D6/382, 388, 389,
D6/392-395, 505-508, 503; 5/53.1, 279.1,
280, 281, 907, 285, 310

(56) **References Cited**

U.S. PATENT DOCUMENTS

D41,640 S * 8/1911 Moore D6/395
D278,488 S * 4/1985 West D6/508
D458,472 S * 6/2002 Risdon D6/393

OTHER PUBLICATIONS

Thomasville, Impressions c2000, bed headboard on front cover.*

Burlington, Stone Gate, c1983, headboard at bottom right.*

* cited by examiner

Primary Examiner—Janice E. Seeger

(74) *Attorney, Agent, or Firm*—Rosenberg, Klein & Lee

(57) **CLAIM**

The ornamental design for a bed footboard, as shown and described.

DESCRIPTION

FIG. 1 is a perspective view of a bed footboard, showing my new design;

FIG. 2 is a front elevational view thereof;

FIG. 3 is a rear elevational view thereof;

FIG. 4 is a left elevational view thereof;

FIG. 5 is a right elevational view thereof;

FIG. 6 is a top plan view thereof; and,

FIG. 7 is a bottom plan view thereof.

1 Claim, 5 Drawing Sheets

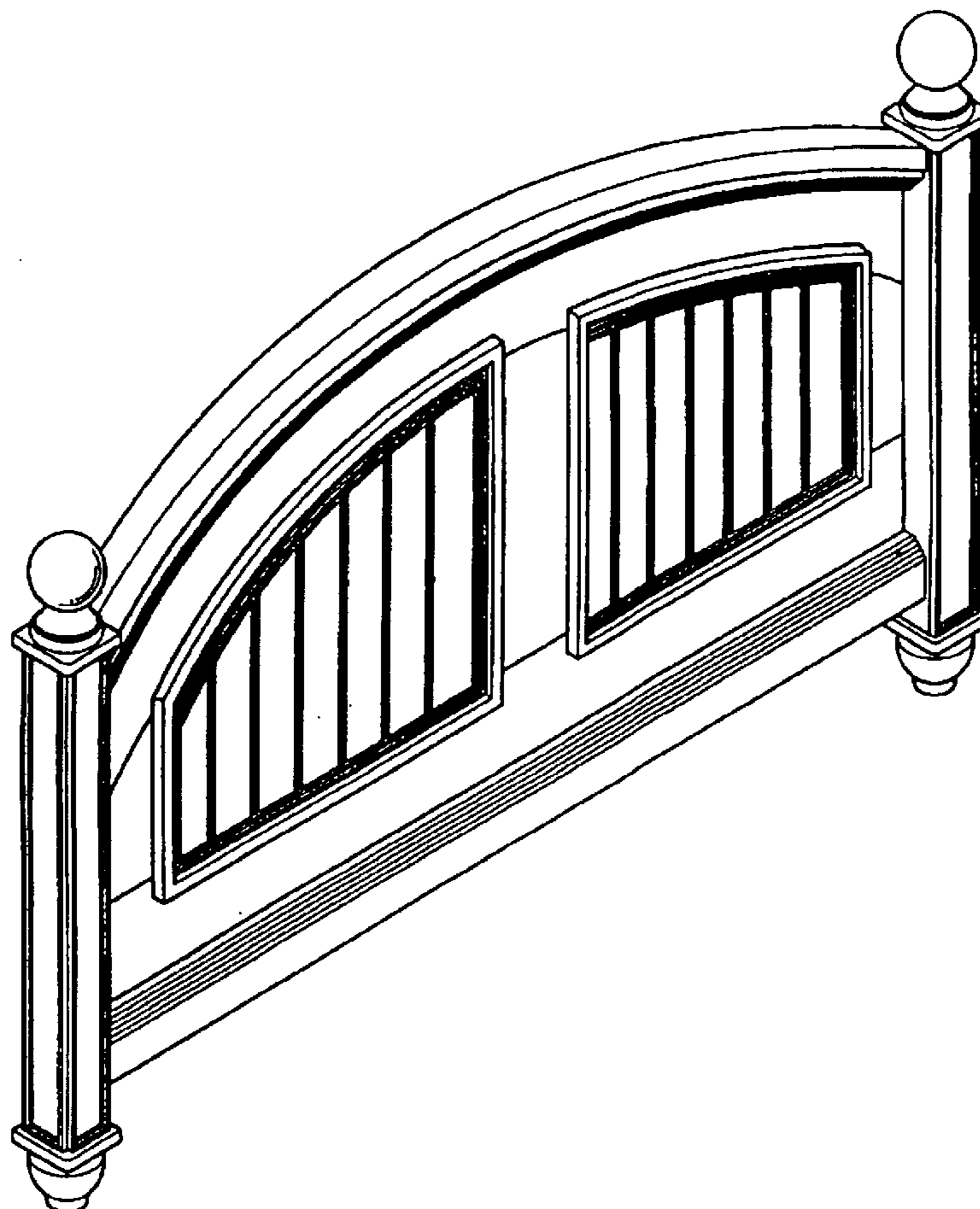

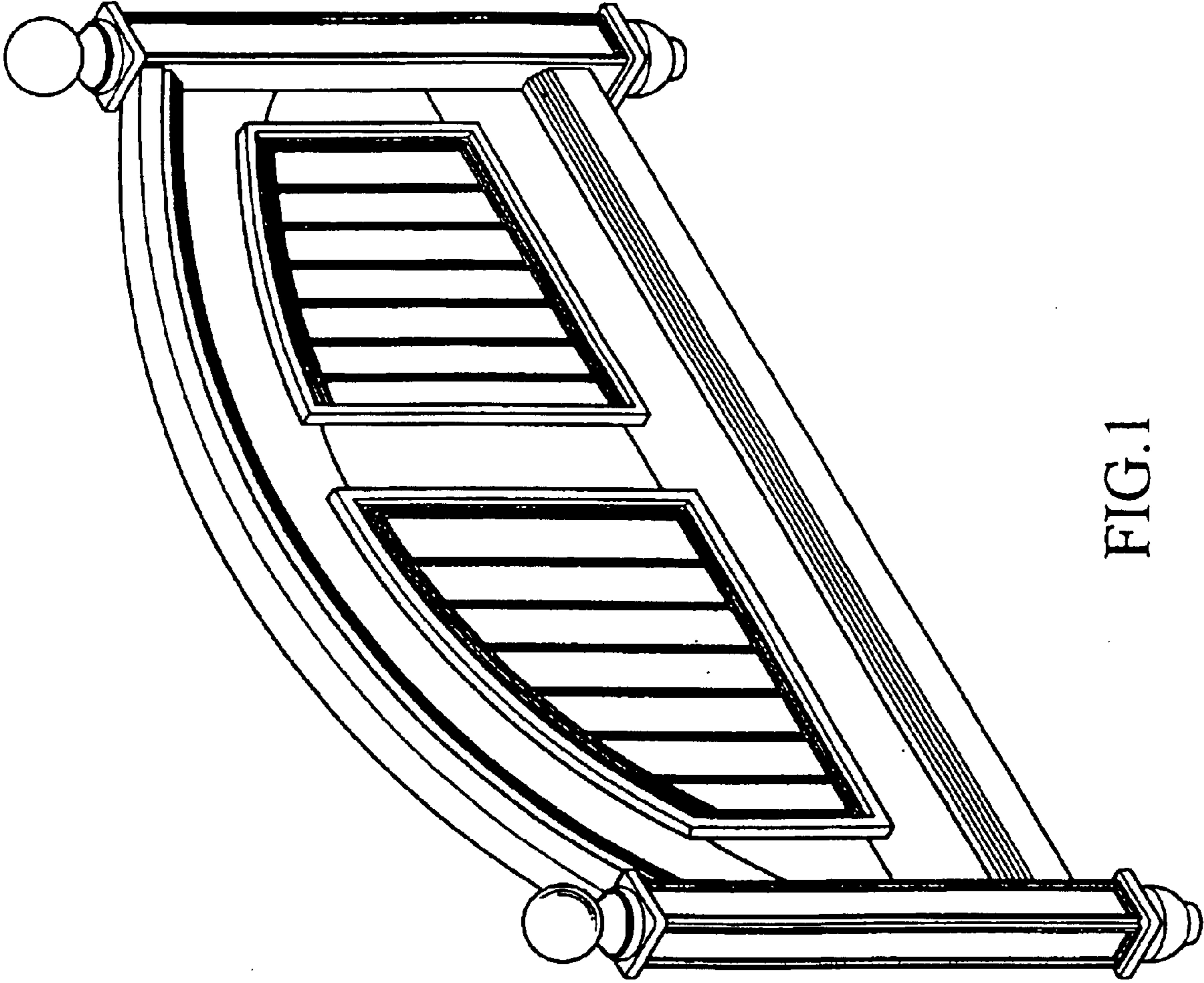

FIG.1

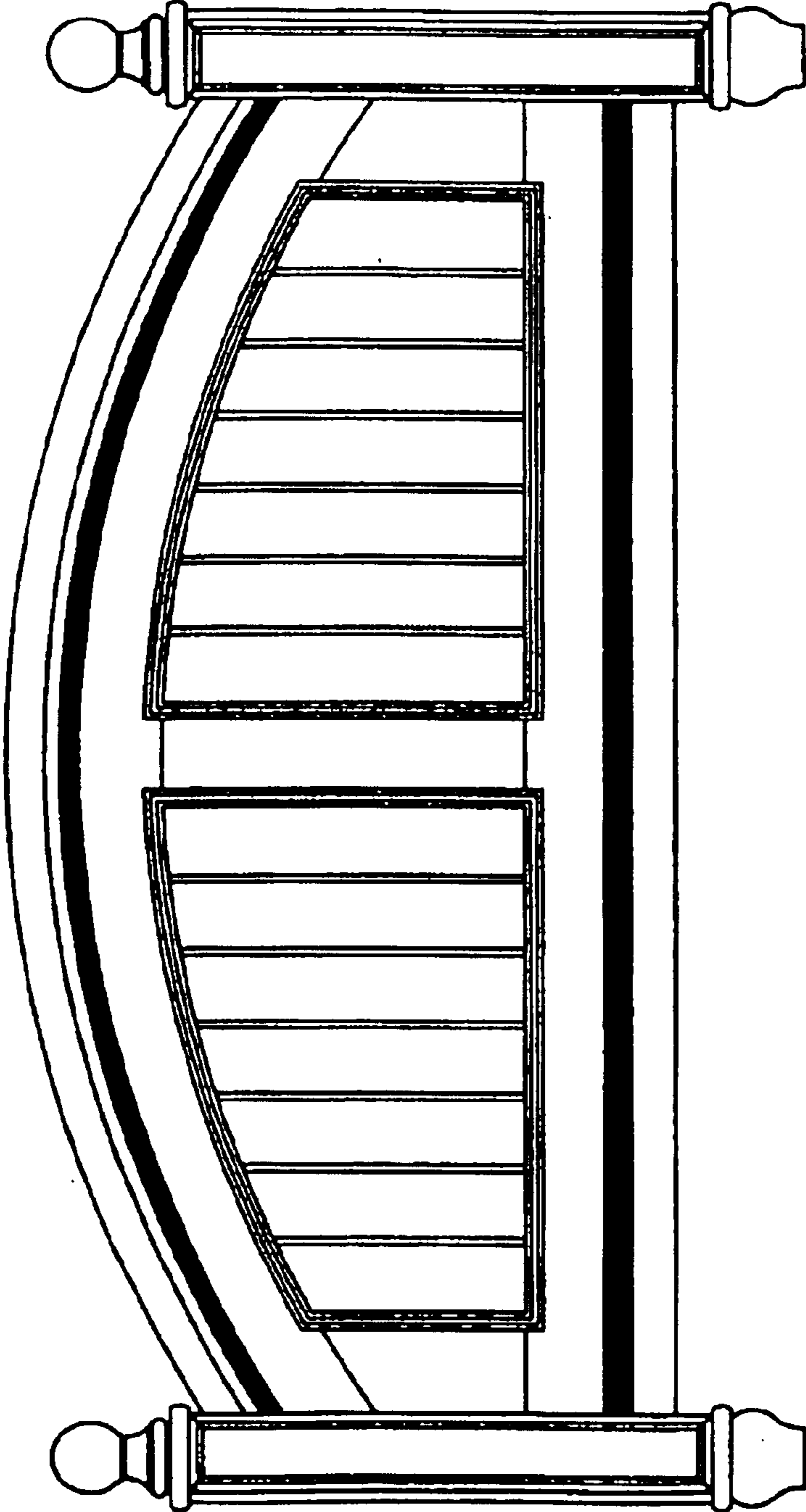

FIG.2

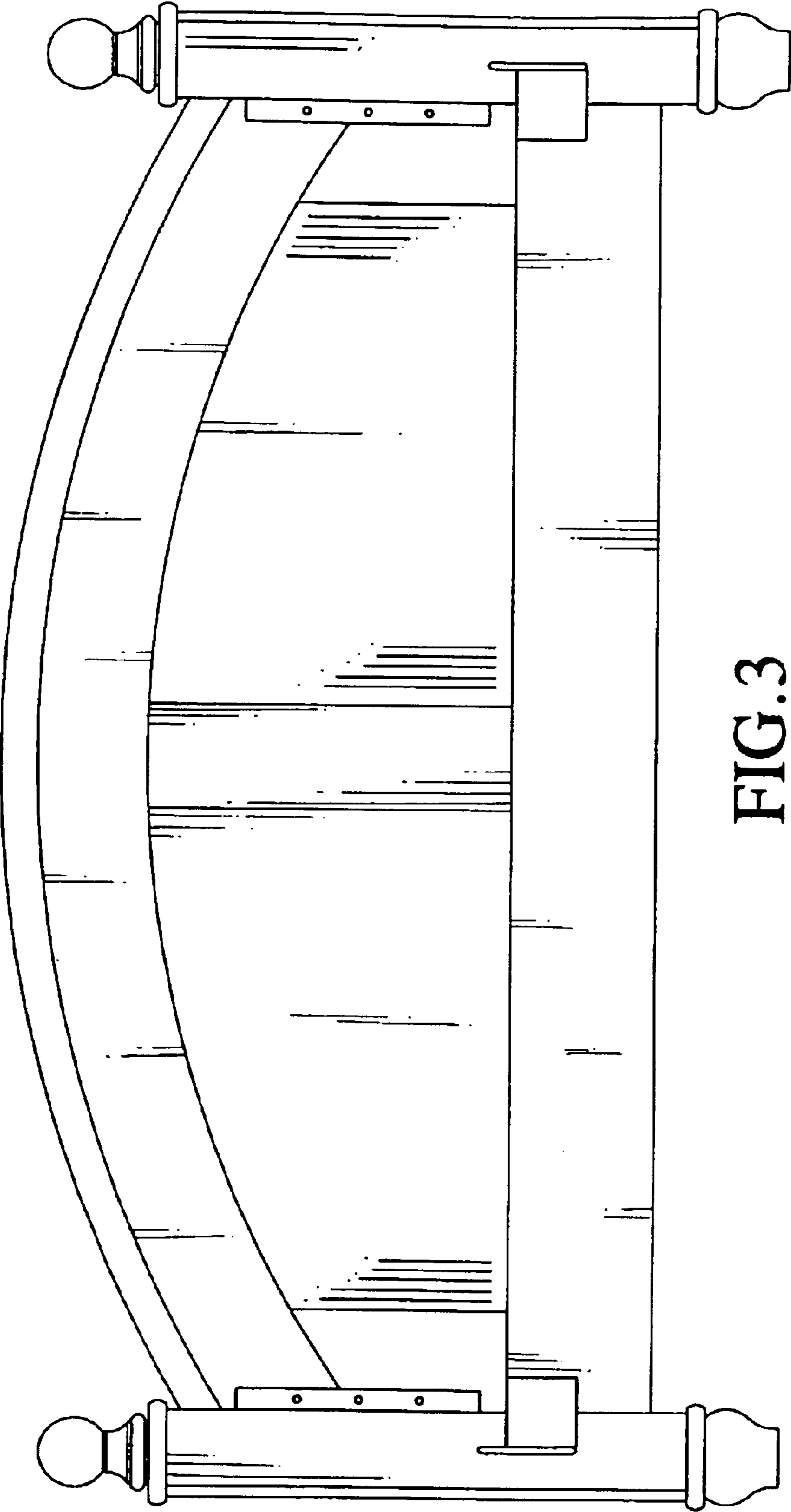

FIG. 3

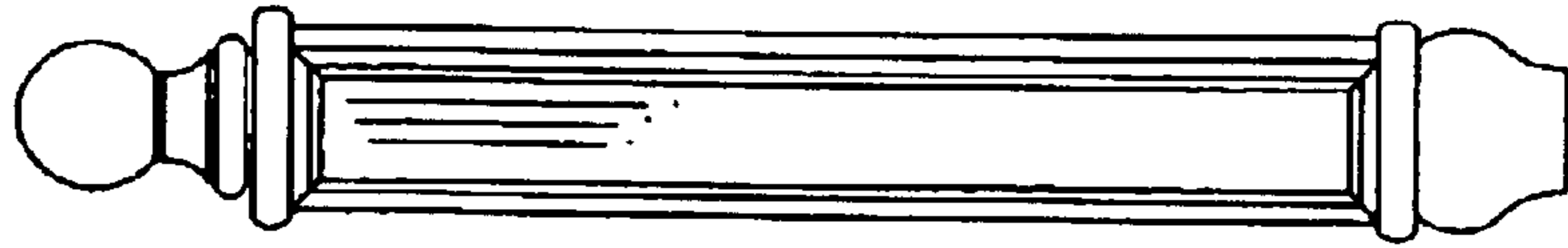

FIG. 4

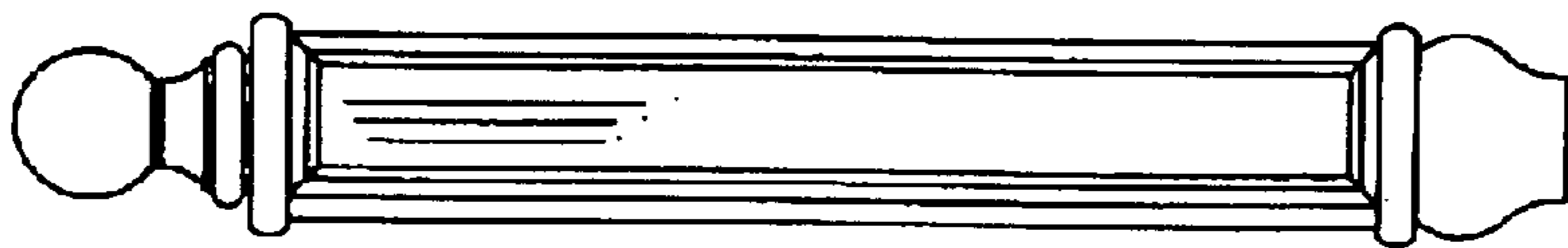

FIG. 5

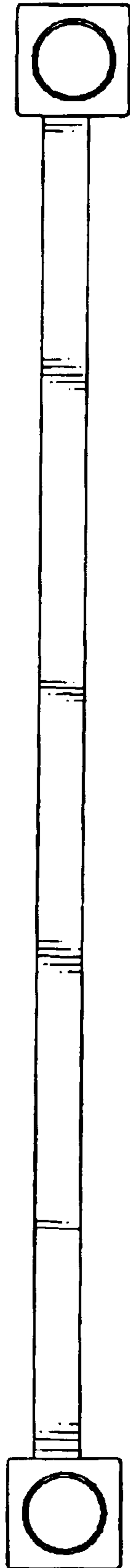

FIG. 6

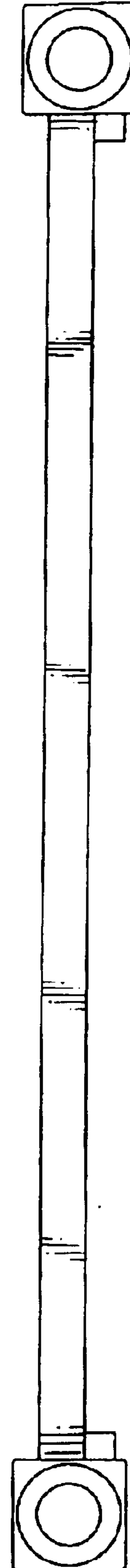

FIG. 7