

US00D505409S

(12) **United States Design Patent**  
**Hirano**

(10) **Patent No.:** **US D505,409 S**

(45) **Date of Patent:** **\*\* May 24, 2005**

(54) **COMBINED DISC PLAYER, RADIO RECEIVER AND TAPE RECORDER**

D475,360 S 6/2003 Yoneda et al.  
D477,299 S \* 7/2003 Kobayashi ..... D14/168

(75) Inventor: **Shinpei Hirano**, Tokyo (JP)

(73) Assignee: **Sony Corporation**, Tokyo (JP)

(\*\*) Term: **14 Years**

(21) Appl. No.: **29/200,801**

(22) Filed: **Mar. 5, 2004**

(51) **LOC (7) Cl.** ..... **14-01**

(52) **U.S. Cl.** ..... **D14/168**

(58) **Field of Search** ..... D14/135-136,  
D14/160-168, 188, 197-198, 156-157;  
455/100, 344, 346-351, 157.1, 350; 369/75.1,  
75.2, 77.2

(56) **References Cited**

**U.S. PATENT DOCUMENTS**

- D329,850 S \* 9/1992 Kang ..... D14/164
- D442,160 S 5/2001 Tsuchiya
- D449,589 S \* 10/2001 Ishibashi et al. .... D14/171
- D452,963 S 1/2002 Suzuki
- D454,856 S 3/2002 Kobayashi
- D457,880 S 5/2002 Suzuki et al.

**OTHER PUBLICATIONS**

Web page "CFD-S26" [http://www.sony.jp/products/rtc/prod/radicasse/cfd-s26\\_p.html](http://www.sony.jp/products/rtc/prod/radicasse/cfd-s26_p.html), 1 sheet, Sony (Aug. 2003).

\* cited by examiner

*Primary Examiner*—Nanda Bondade

(74) *Attorney, Agent, or Firm*—Rader, Fishman & Grauer PLLC

(57) **CLAIM**

The ornamental design for a combined disc player, radio receiver and tape recorder, as shown.

**DESCRIPTION**

FIG. 1 is a perspective view of a combined disc player, radio receiver and tape recorder showing my new design; FIG. 2 is a front elevational view thereof; FIG. 3 is a rear elevational view thereof; FIG. 4 is a left side elevational view thereof; FIG. 5 is a right side elevational view thereof; FIG. 6 is a top plan view thereof; and, FIG. 7 is a bottom plan view thereof.

**1 Claim, 4 Drawing Sheets**

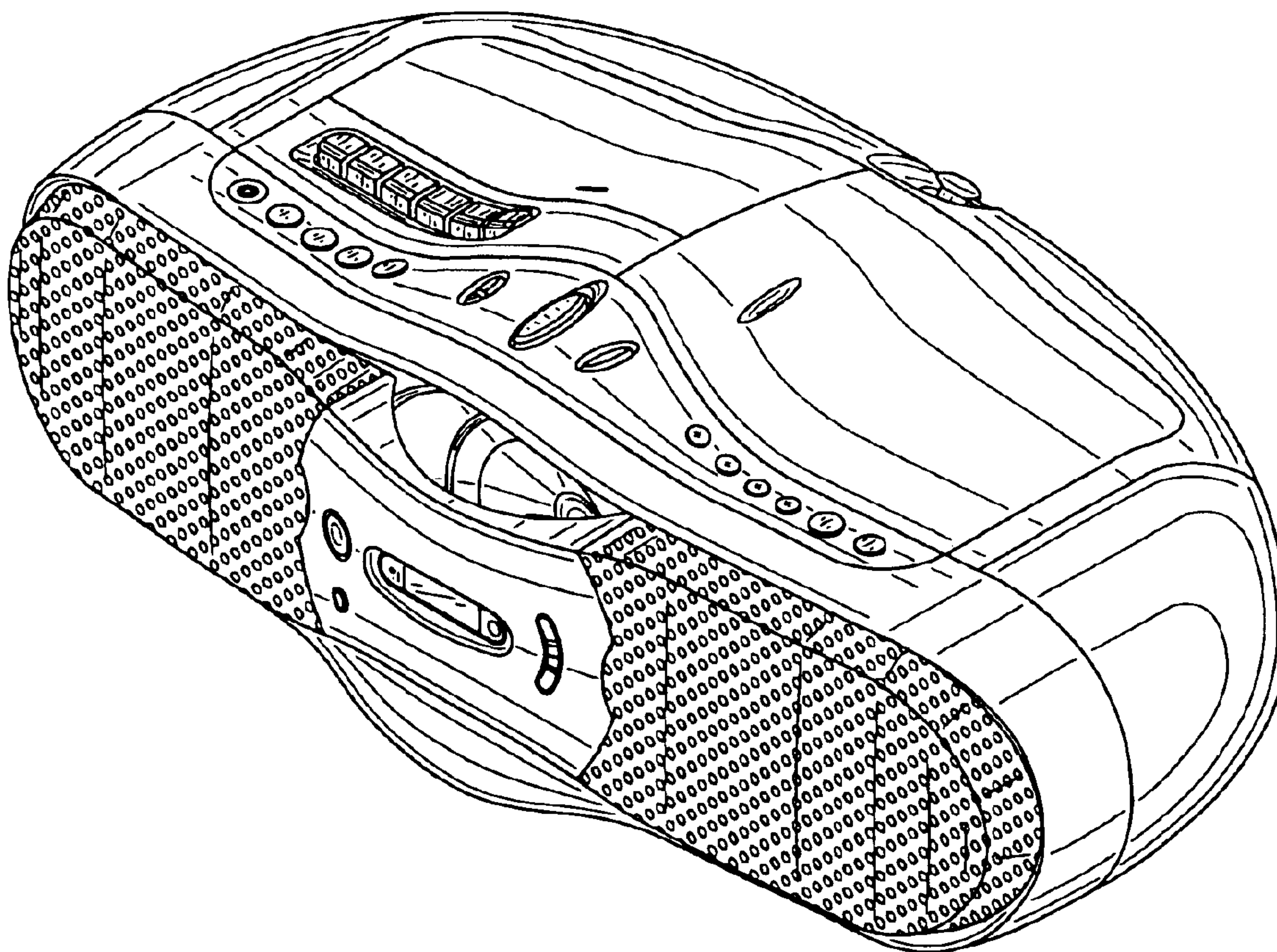

Fig. 1

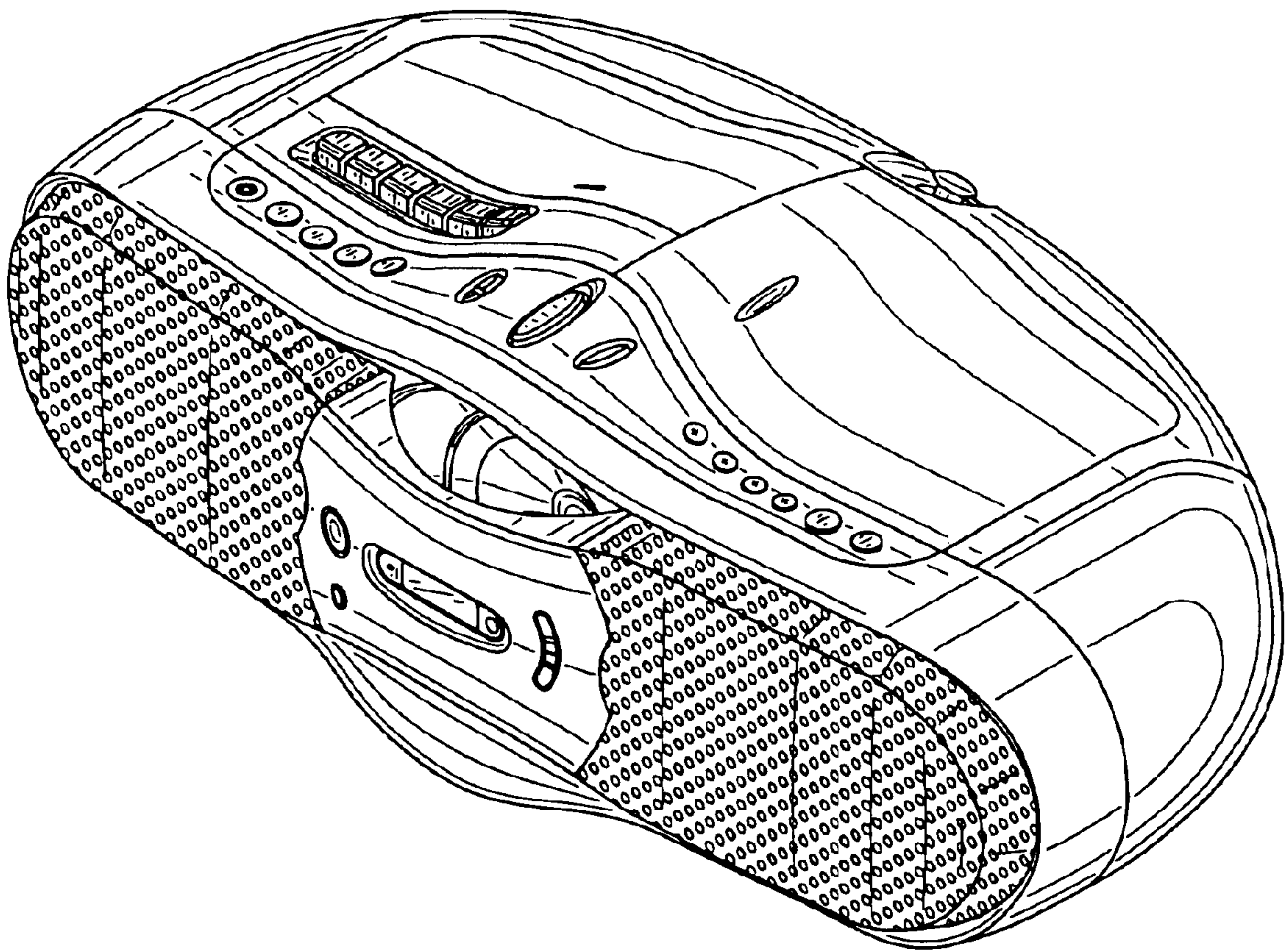



Fig.2

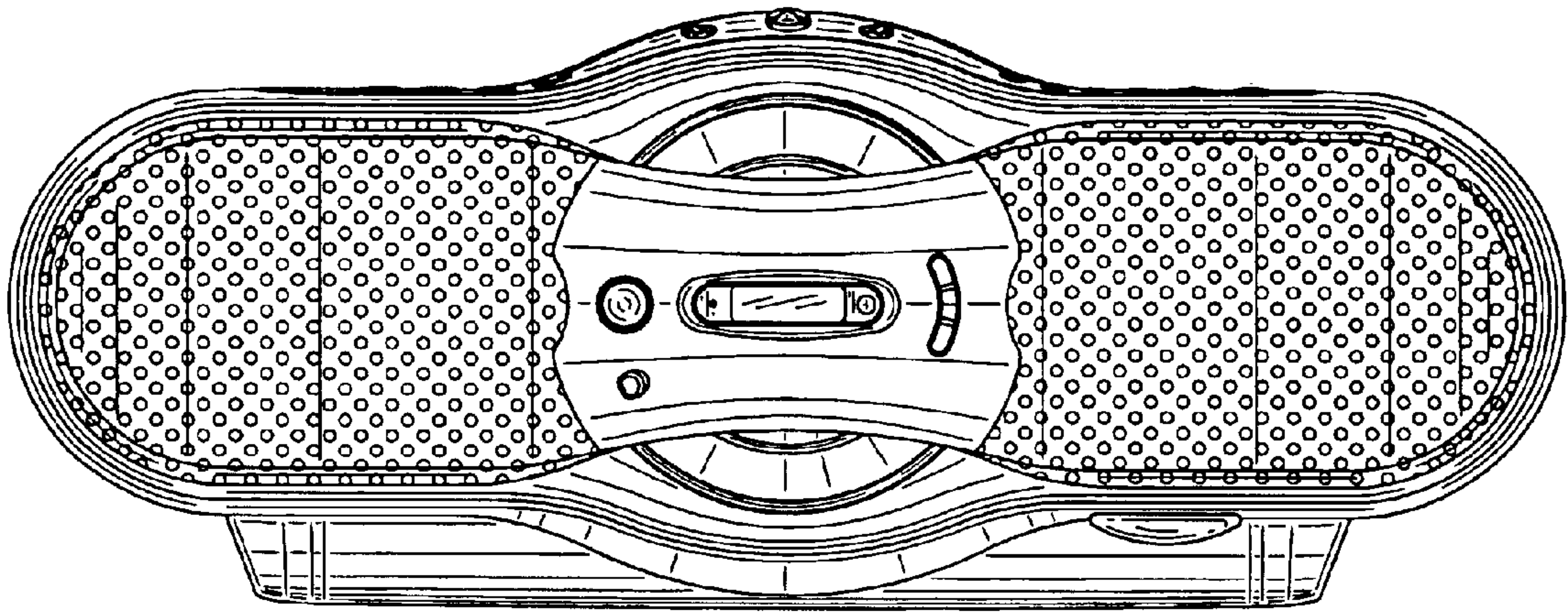

Fig.3

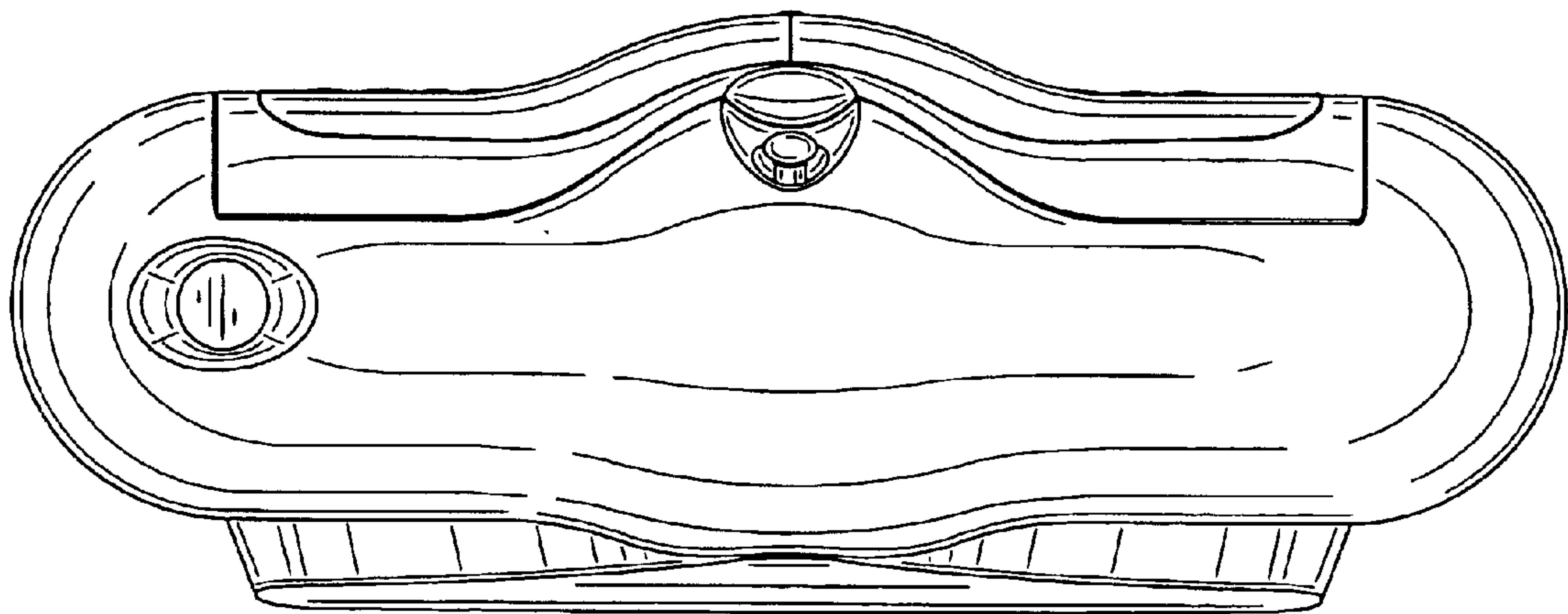

Fig.4

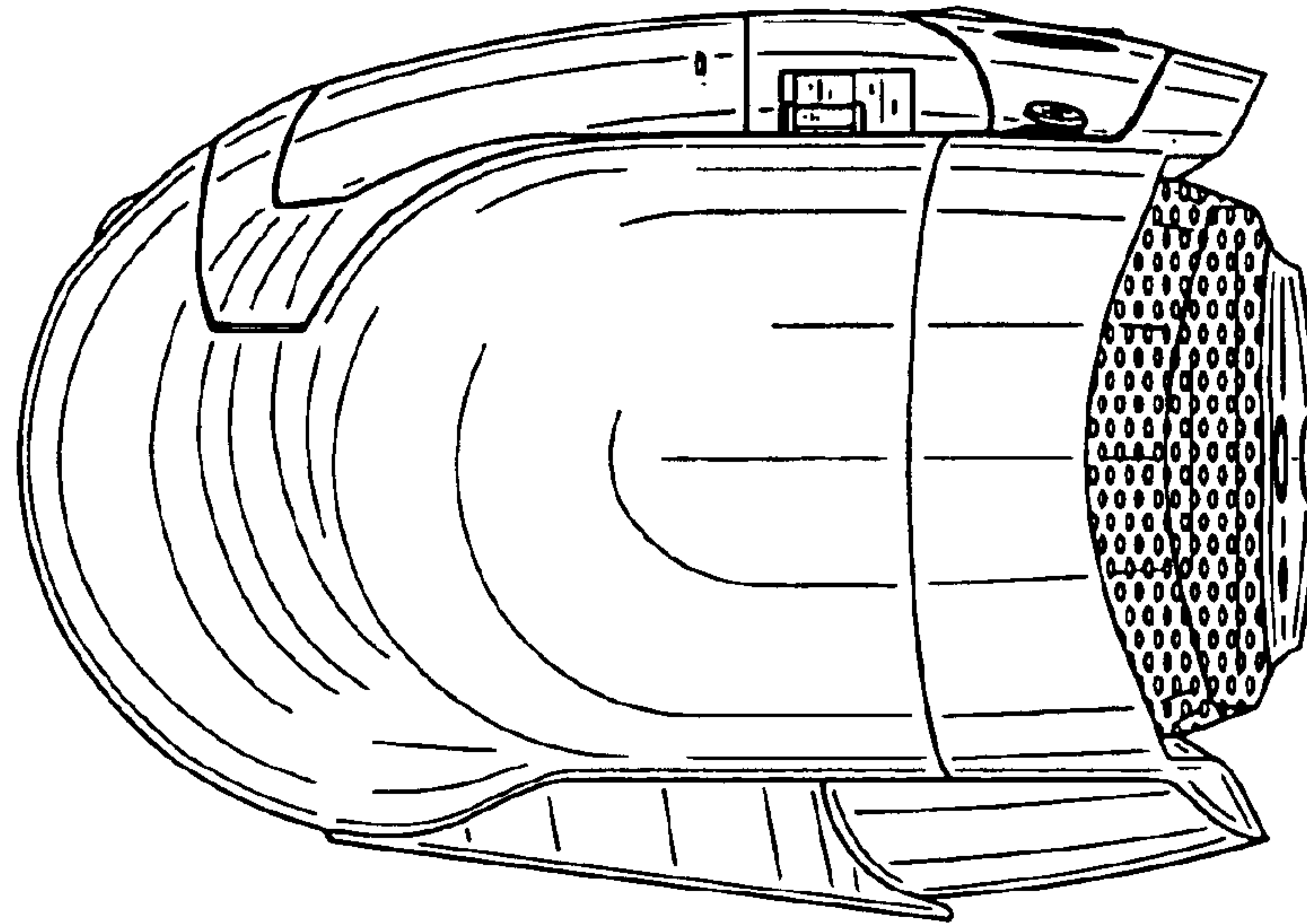

Fig.5

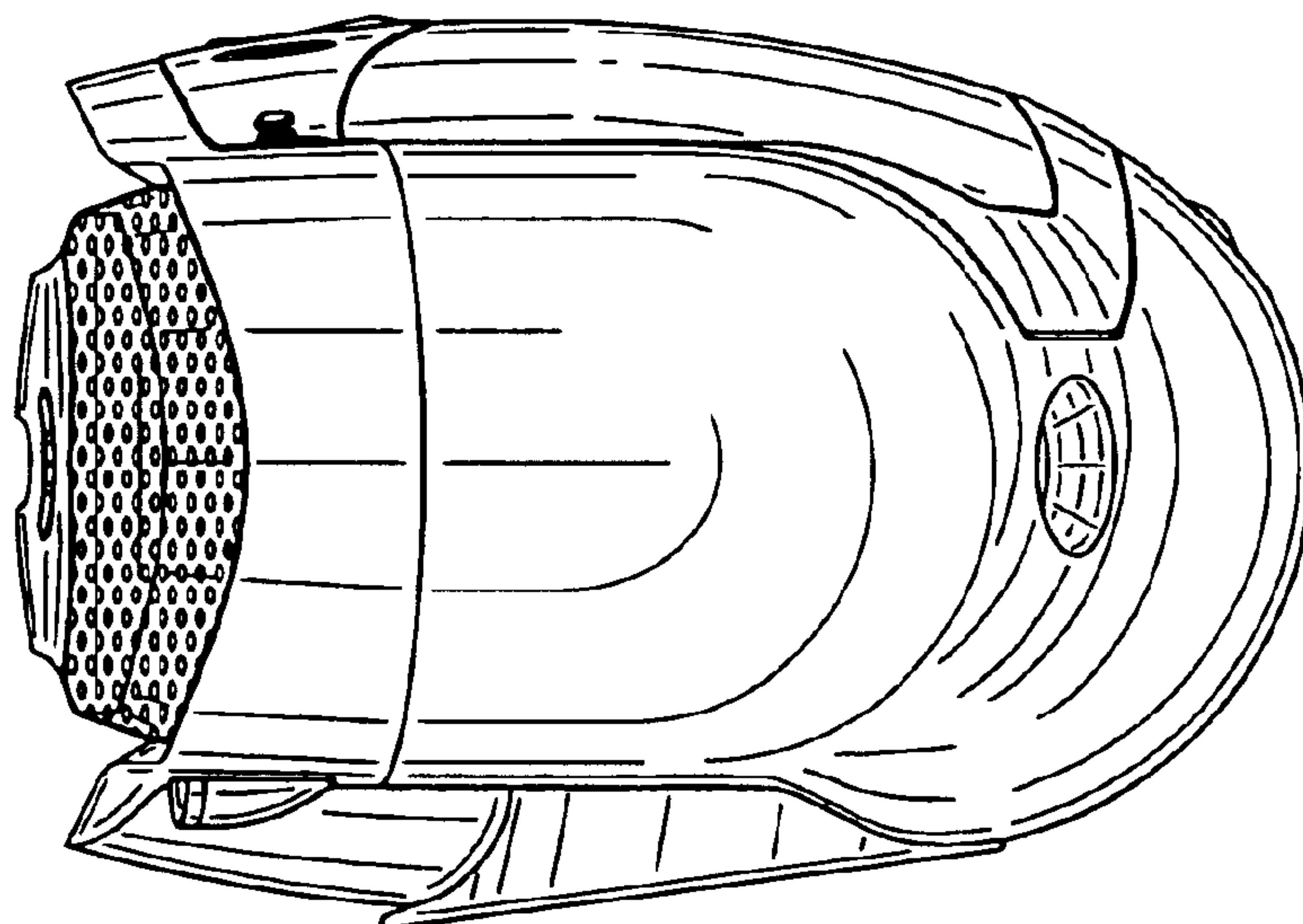

Fig.6

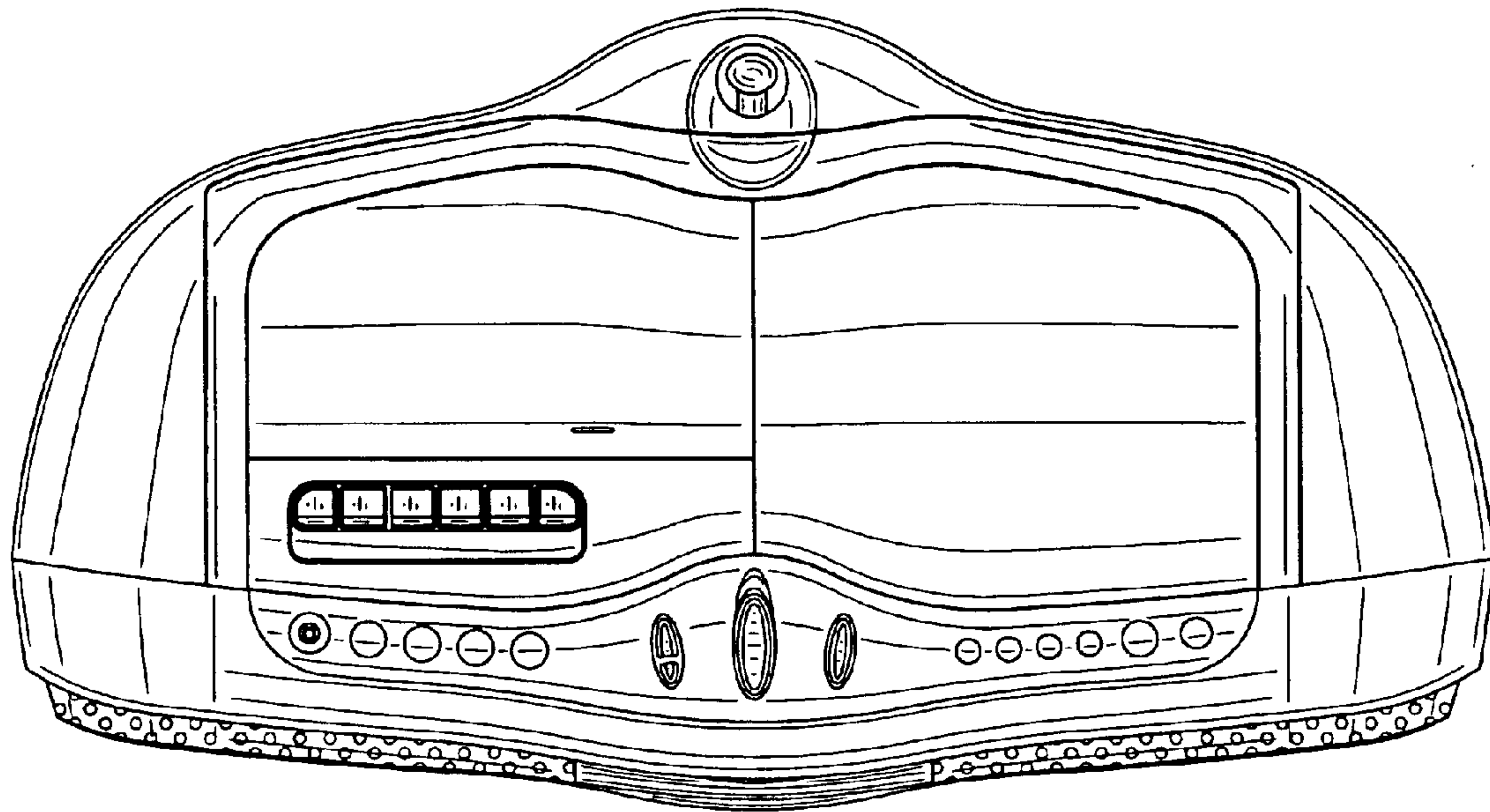

Fig.7

