

US00D505256S

(12) **United States Design Patent** (10) **Patent No.:** **US D505,256 S**
Nepp (45) **Date of Patent:** **** May 24, 2005**

(54) **RIBBON ORGANIZER**

(76) Inventor: **Keith Nepp**, 1750 W. Romneya Dr.
#217, Anaheim, CA (US) 92801

(**) Term: **14 Years**

(21) Appl. No.: **29/199,219**

(22) Filed: **Feb. 11, 2004**

(51) **LOC (7) Cl.** **03-07**

(52) **U.S. Cl.** **D3/25**

(58) **Field of Search** D3/18, 20, 23-25,
D3/259, 304, 315; 206/225-227, 49, 389;
242/594.4, 129.6, 129.62; 223/106

(56) **References Cited**

U.S. PATENT DOCUMENTS

| | | | | |
|---------------|---------|-------------|-------|------------|
| 1,136,854 A * | 4/1915 | Wechsler | | 242/129.62 |
| 1,946,276 A | 2/1934 | Barberena | | 206/52 |
| 4,186,833 A | 2/1980 | Homan | | 206/225 |
| D272,954 S * | 3/1984 | Sparks | | D6/467 |
| 5,887,819 A * | 3/1999 | Korn et al. | | 242/129.6 |
| D417,958 S * | 12/1999 | West | | D3/315 |
| 6,382,377 B2 | 5/2002 | Godshaw | | 190/110 |

* cited by examiner

Primary Examiner—Robert A. Delehanty
(74) *Attorney, Agent, or Firm*—Goldstein Law Offices, P.C.

(57) **CLAIM**

The ornamental design for a ribbon organizer, as shown and described.

DESCRIPTION

FIG. 1 is a perspective view of the ribbon organizer.
 FIG. 2 is a perspective view of the ribbon organizer illustrating the rod, which holds the ribbon spools, being removed from the frame of the ribbon organizer for refilling and replacing the spools thereon.
 FIG. 3 is a front elevational view of the ribbon organizer.
 FIG. 4 is a rear elevational view thereof.
 FIG. 5 is a right elevational view thereof, the left side view being a mirror image of the right side view.
 FIG. 6 is a top plan view thereof; and,
 FIG. 7 is a bottom plan view thereof.
 The broken line showing of a plurality of ribbon spools is for illustrative purposes only and forms no part of the claimed design.

1 Claim, 5 Drawing Sheets

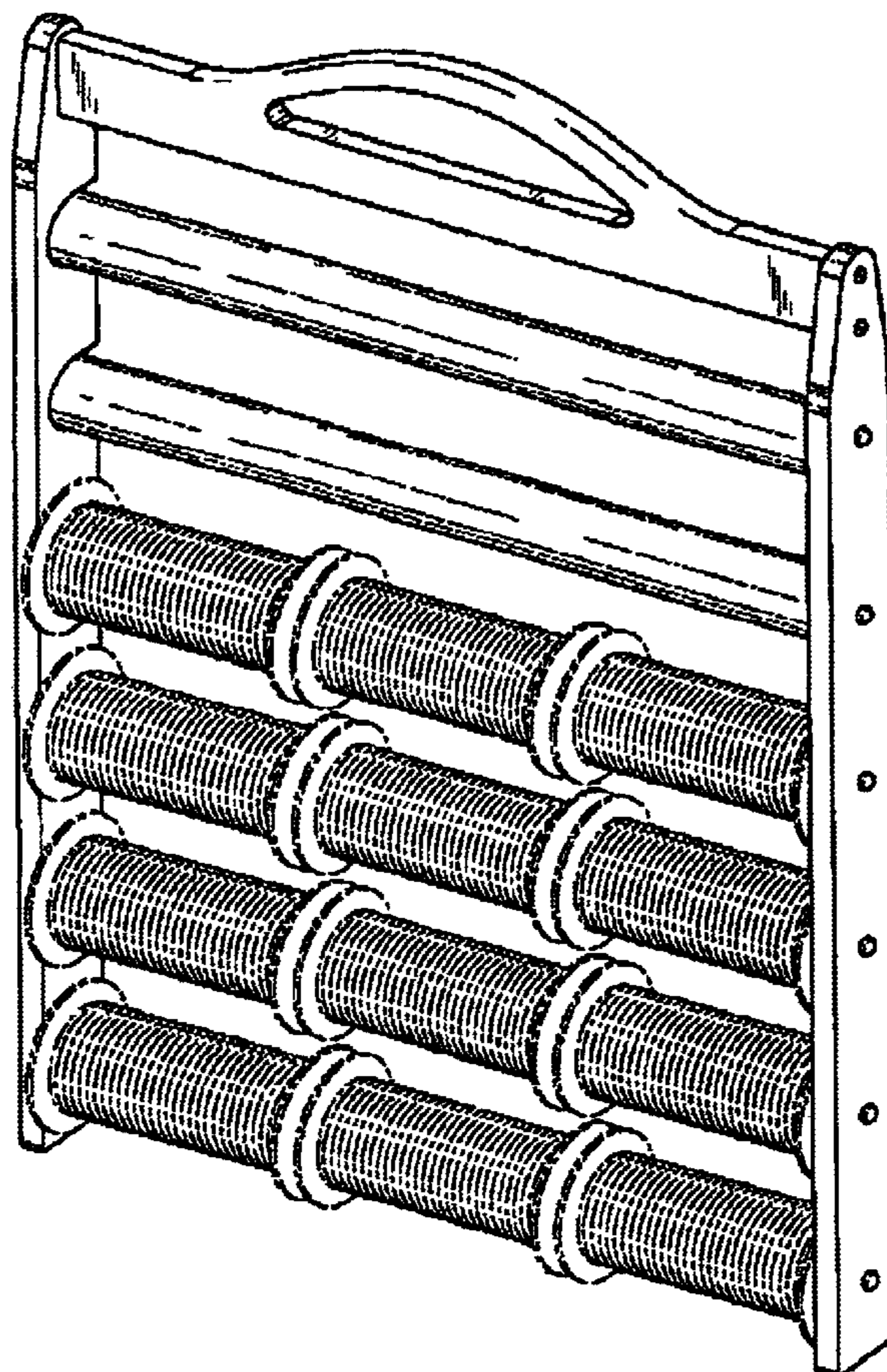

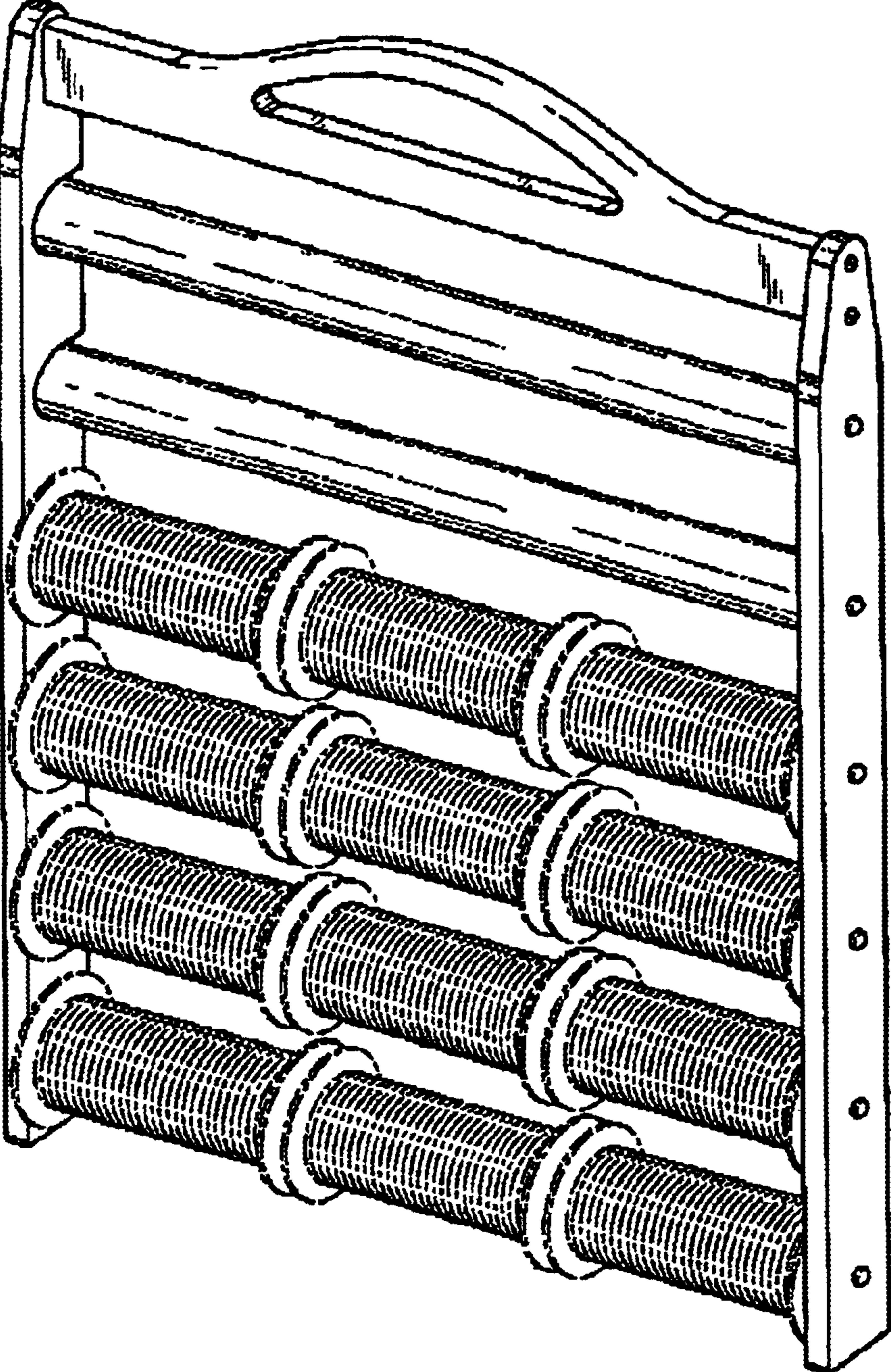

FIG. 1

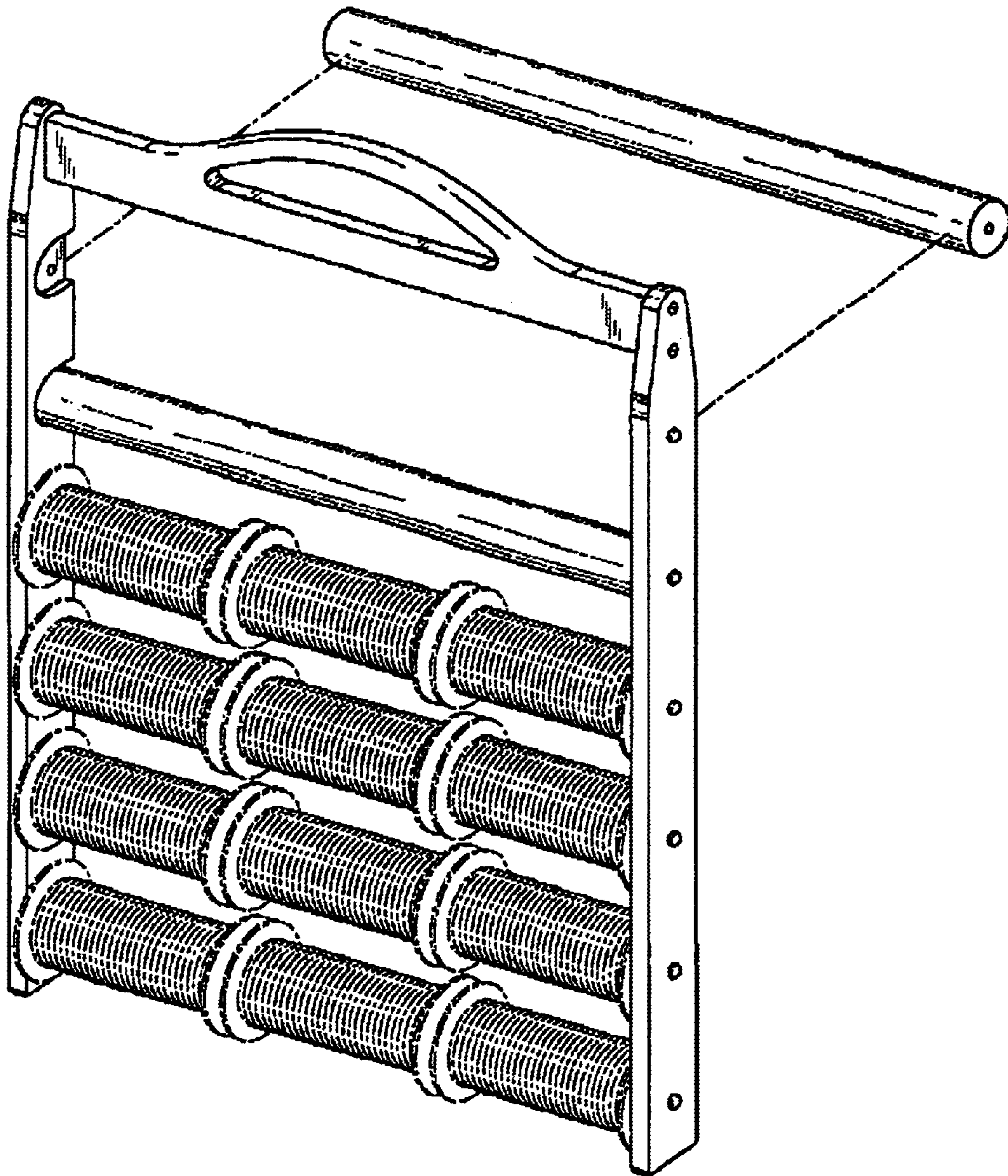

FIG. 2

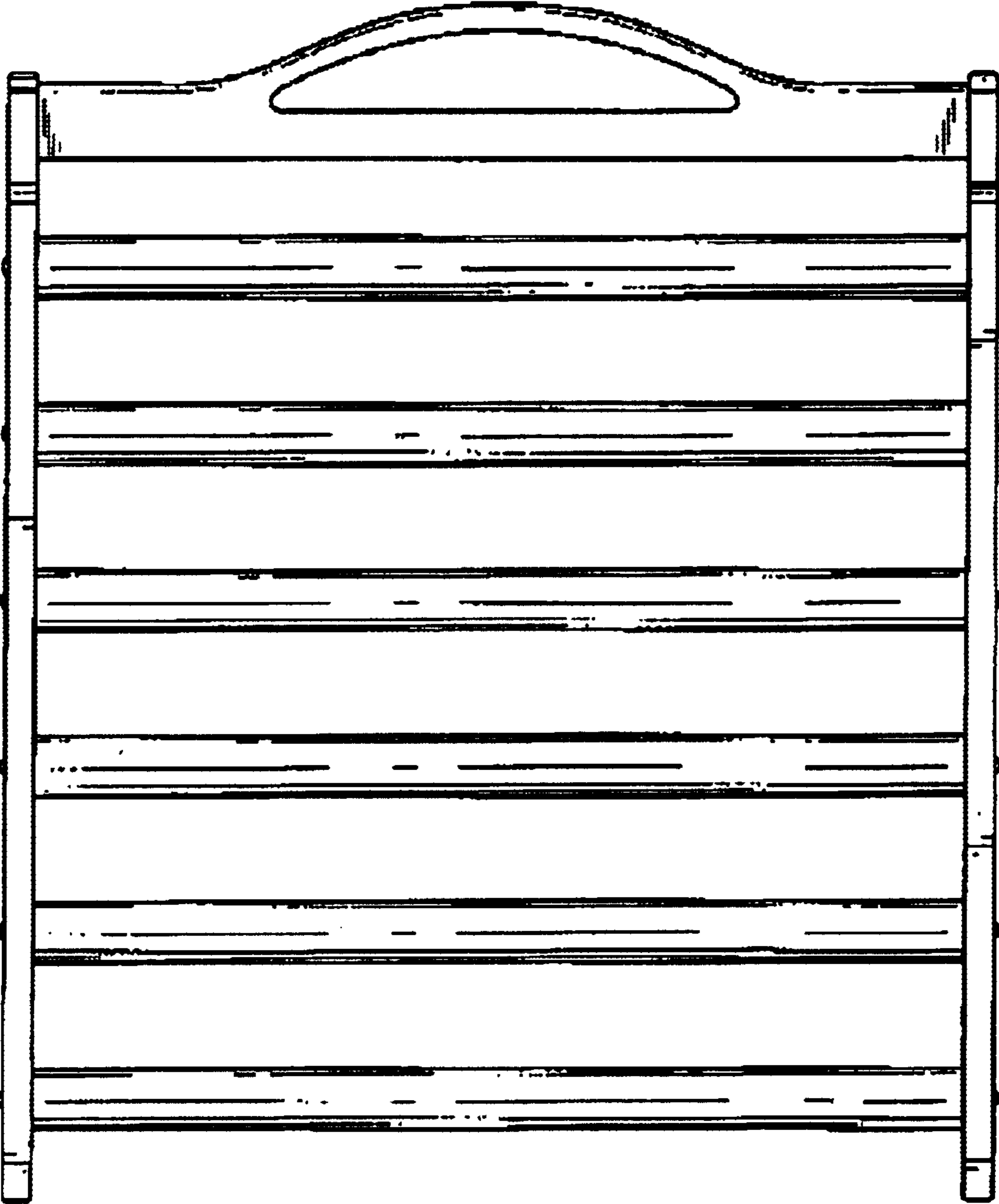

FIG. 3

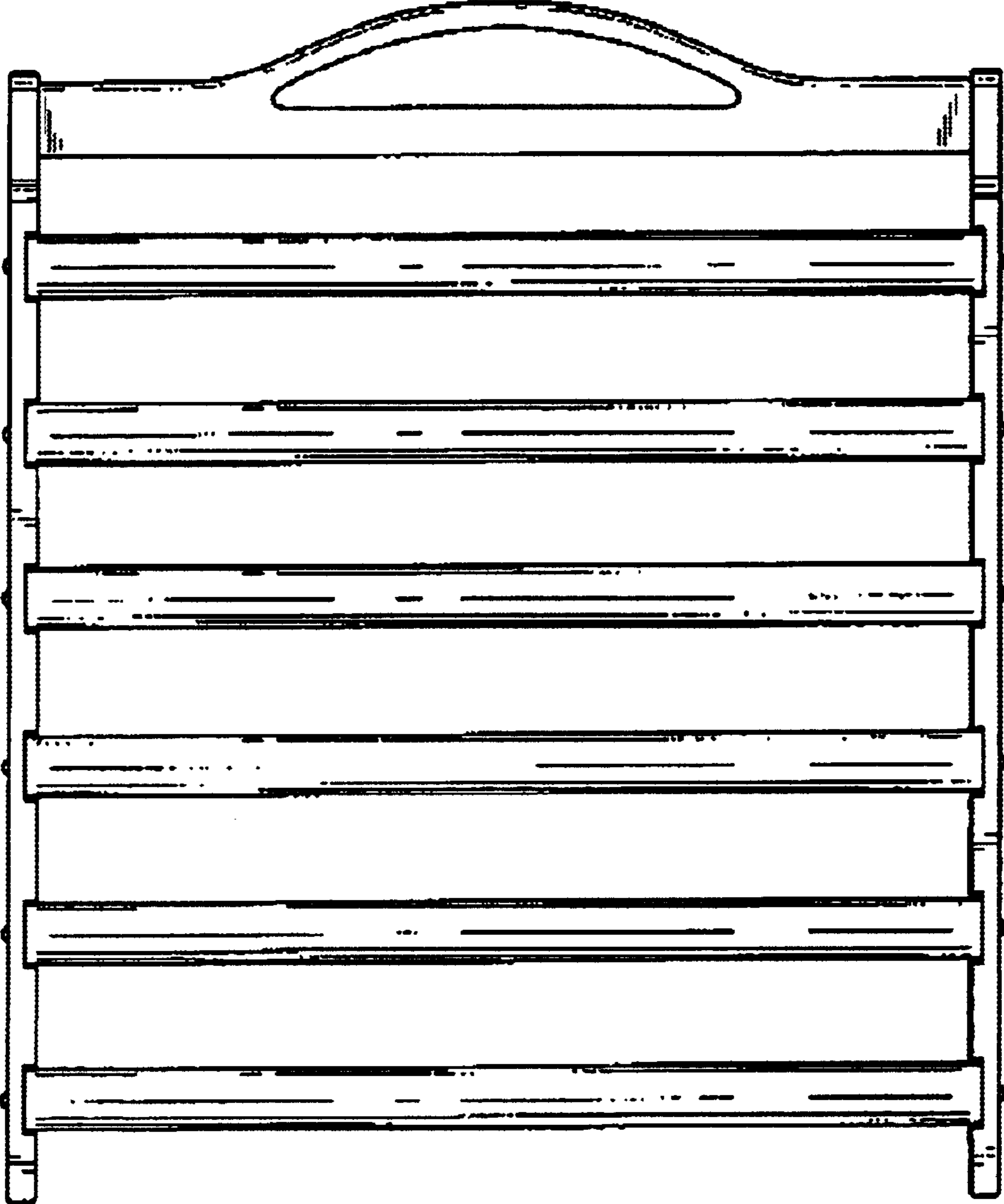

FIG. 4



FIG. 5

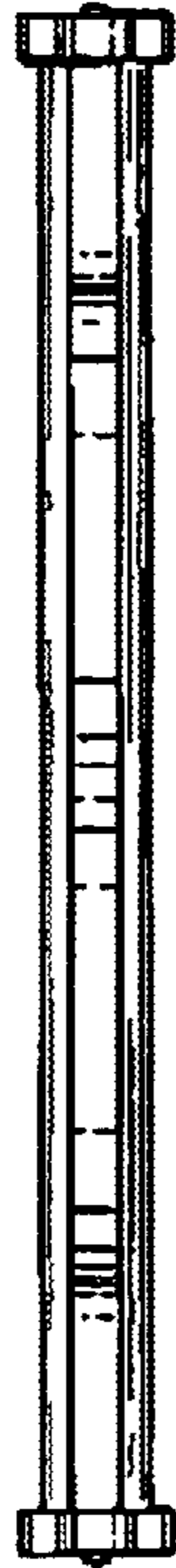

FIG. 6

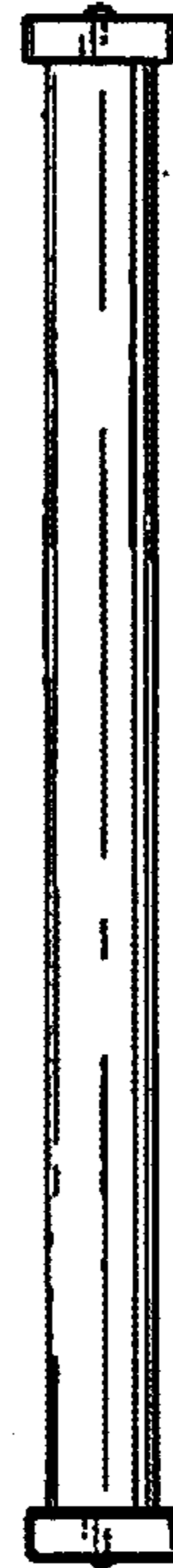

FIG. 7