



US00D505093S

(12) **United States Design Patent**  
**Kothari**

(10) **Patent No.:** **US D505,093 S**  
(45) **Date of Patent:** **\*\* May 17, 2005**

(54) **DIAMOND SETTING COMPRISING OVAL SHAPE TOTAL 10 ROUND DIAMOND**

(75) Inventor: **Prem Kothari**, Mumbai (IN)

(73) Assignee: **Fine Jewellery (India) Ltd.**, Andheri (IN)

(\*\*) Term: **14 Years**

(21) Appl. No.: **29/195,003**

(22) Filed: **Dec. 3, 2003**

(51) **LOC (7) Cl.** ..... **11-01**

(52) **U.S. Cl.** ..... **D11/91**

(58) **Field of Search** ..... D11/89-94, 85-86,  
D11/79-81, 16, 26, 34; 63/15, 26-31, 35

(56) **References Cited**

**U.S. PATENT DOCUMENTS**

434,405	A	*	8/1890	Schill	.....	63/28
D149,469	S	*	5/1948	Bogoff	.....	D11/17
D150,675	S	*	8/1948	Bogoff	.....	D11/16
D374,410	S	*	10/1996	Tanory, Jr.	.....	D11/34
D422,935	S	*	4/2000	Chan	.....	D11/92
D460,017	S	*	7/2002	Chan	.....	D11/91

**OTHER PUBLICATIONS**

Spiegel Catalog Spring 2001□□p. 251 Endless Diamonds Jewelry collection.\*

Fendt Finding Company, Inc. 1987□□p. 30 TR189 marquise shape setting.\*

Baker Settings, 1981□□cluster settings.\*

Service Merchandise 1994/95□□p. 37 Item No. 36 and 43-pear-shaped pendants.\*

\* cited by examiner

*Primary Examiner*—Louis S. Zarfes

*Assistant Examiner*—John Windmuller

(74) *Attorney, Agent, or Firm*—Thomas I. Rozsa; Tony D. Chen

(57) **CLAIM**

The Ornamental design for a diamond setting comprising oval shape total 10 round diamond, as shown and described.

**DESCRIPTION**

FIG. 1 is a perspective view of the diamond setting comprising oval shape total 10 round diamond, showing my new design;

FIG. 2 is a top plan view;

FIG. 3 is a bottom plan view;

FIG. 4 is a side elevational view;

FIG. 5 is a top plan view with the diamonds removed; and,

FIG. 6 is a perspective view with the diamonds removed.

**1 Claim, 1 Drawing Sheet**

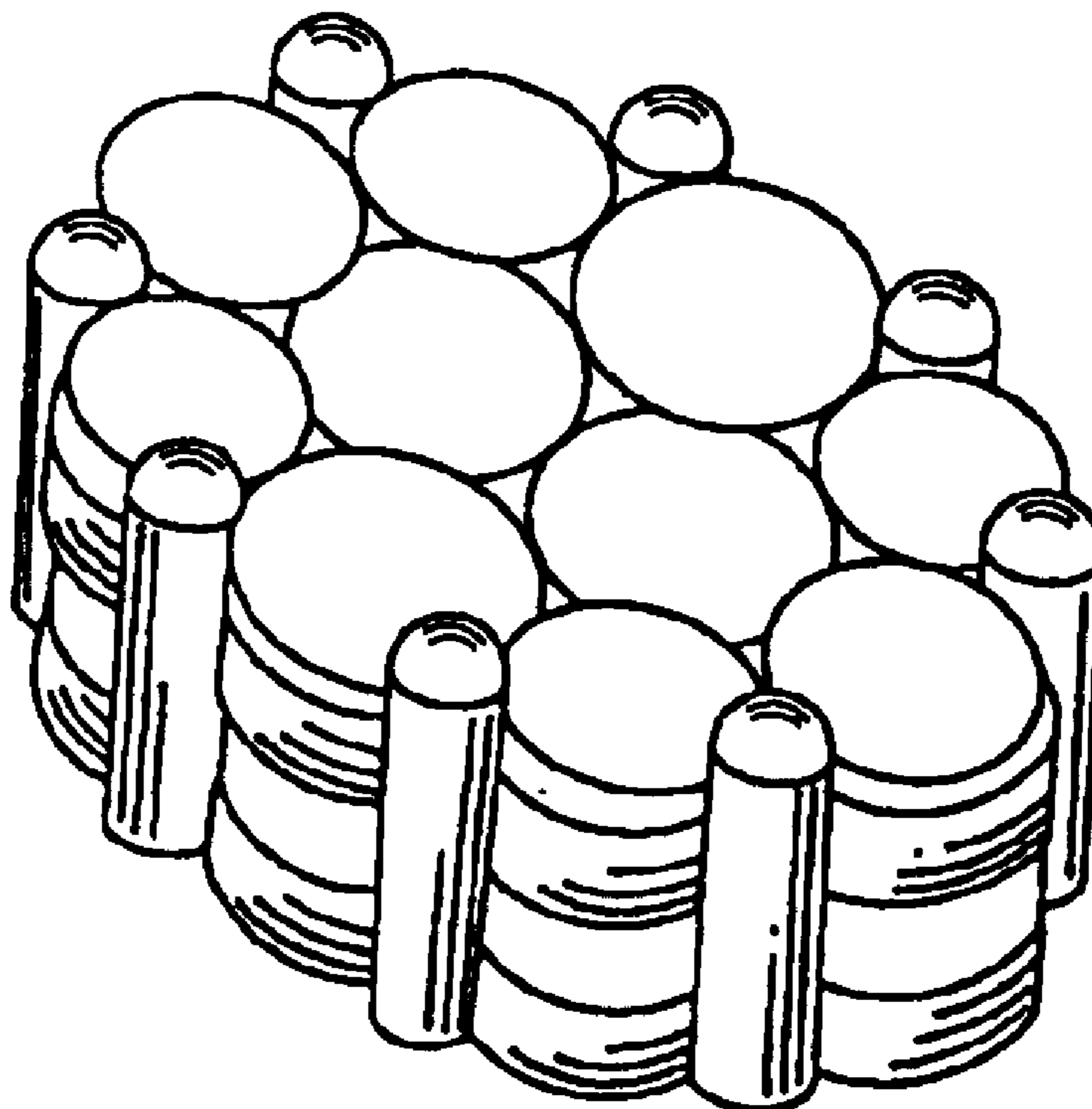

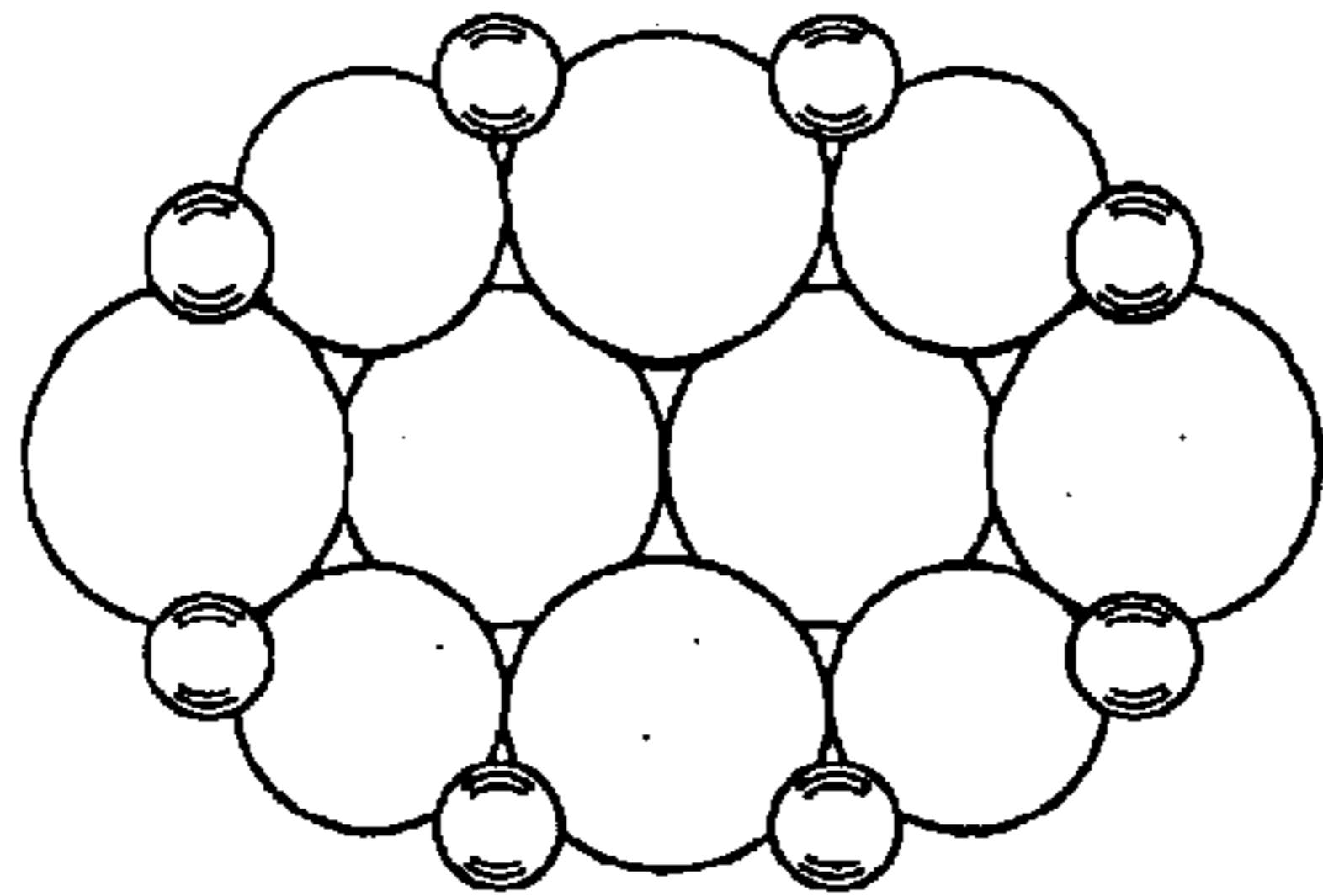

FIG. 2

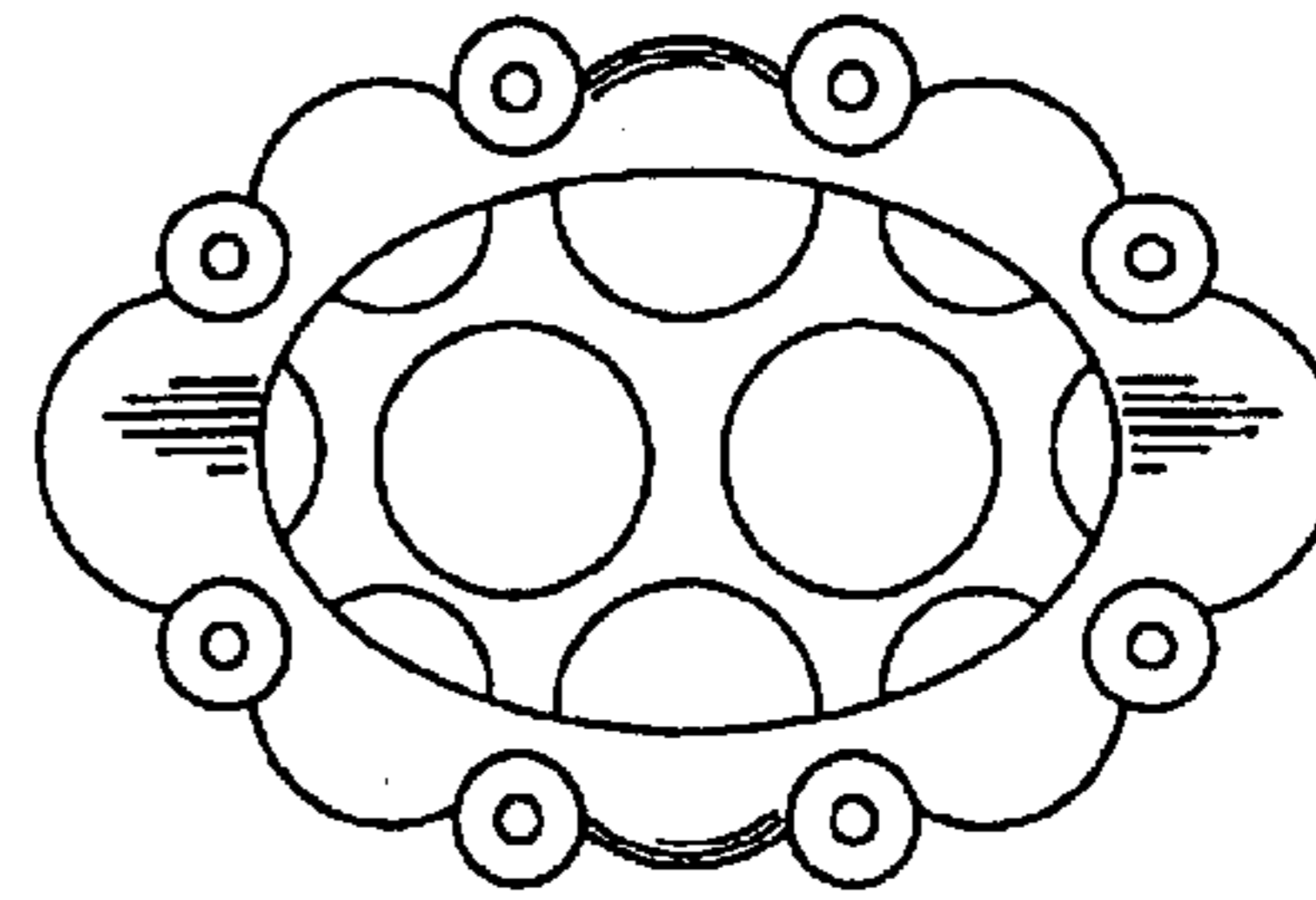

FIG. 3

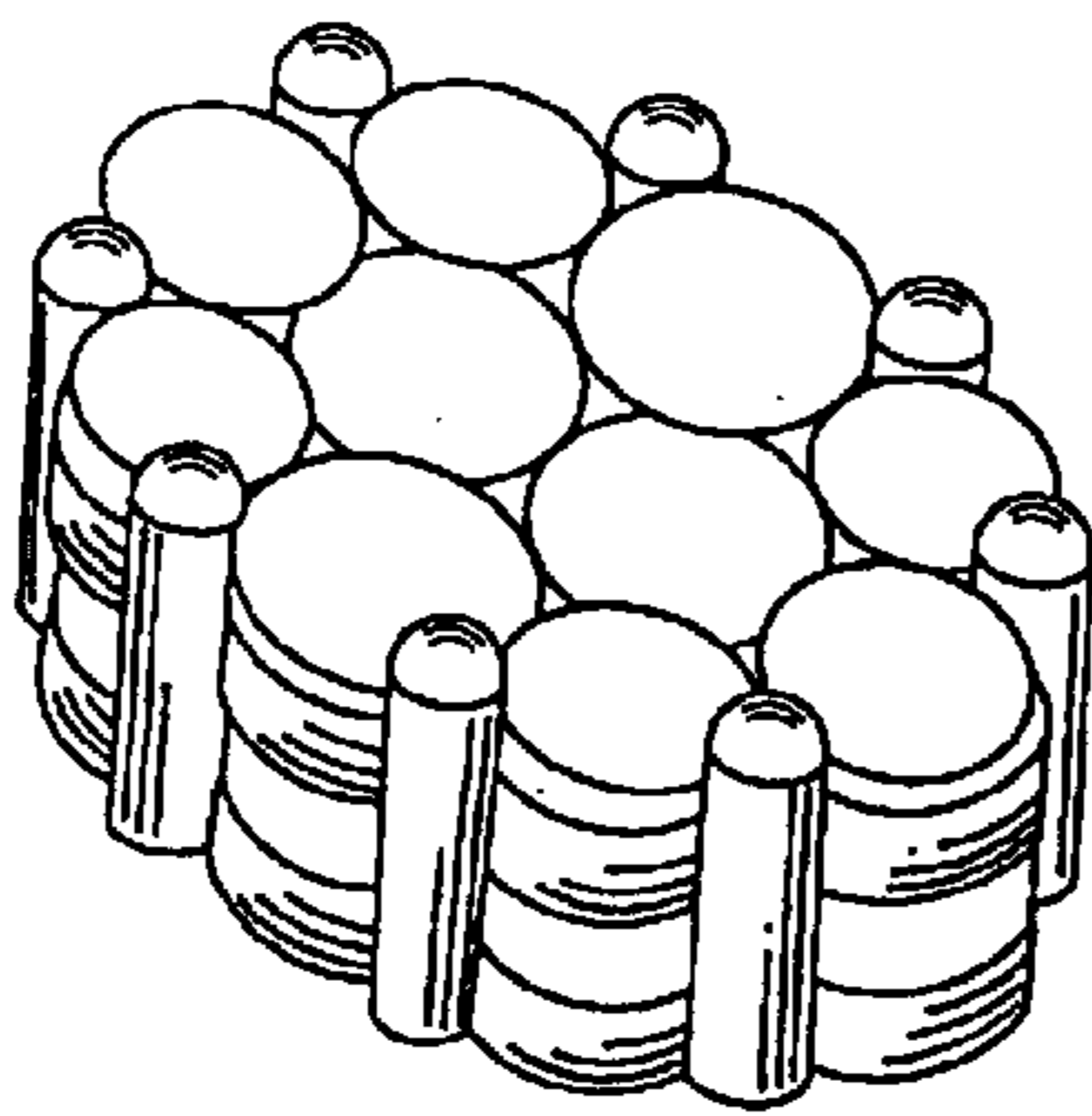

FIG. 1

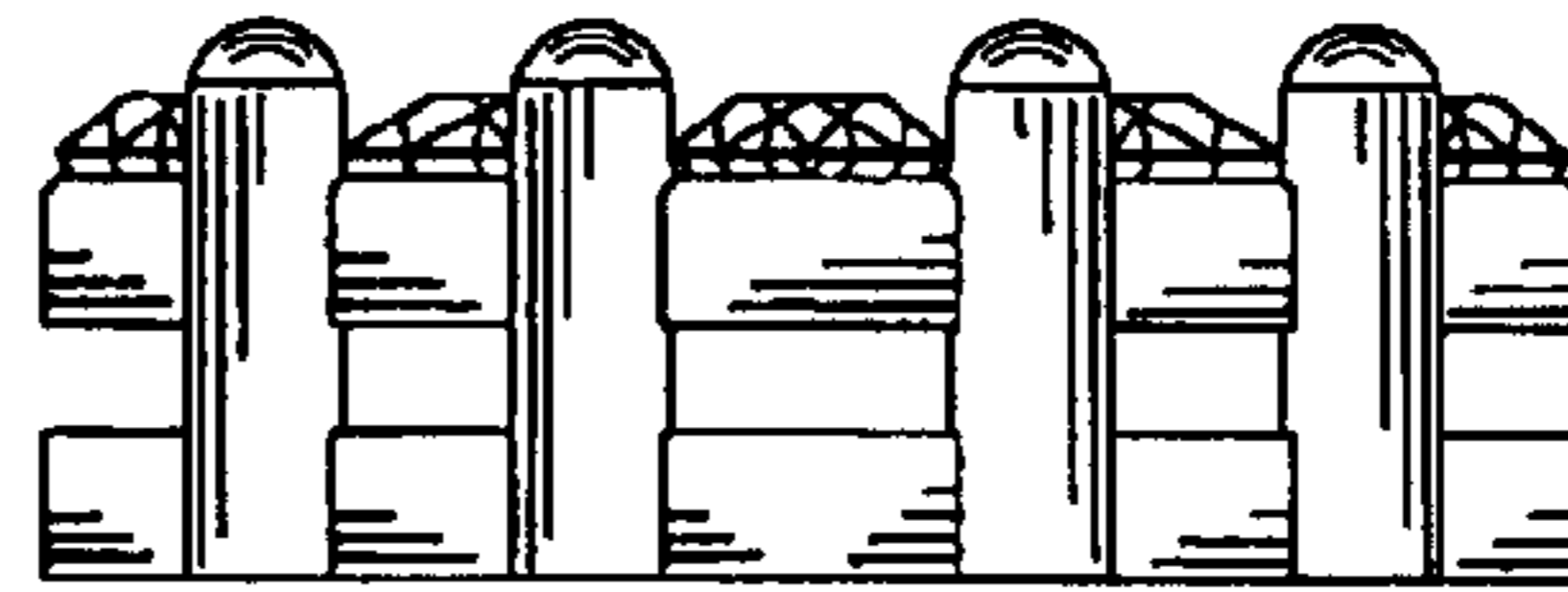

FIG. 4

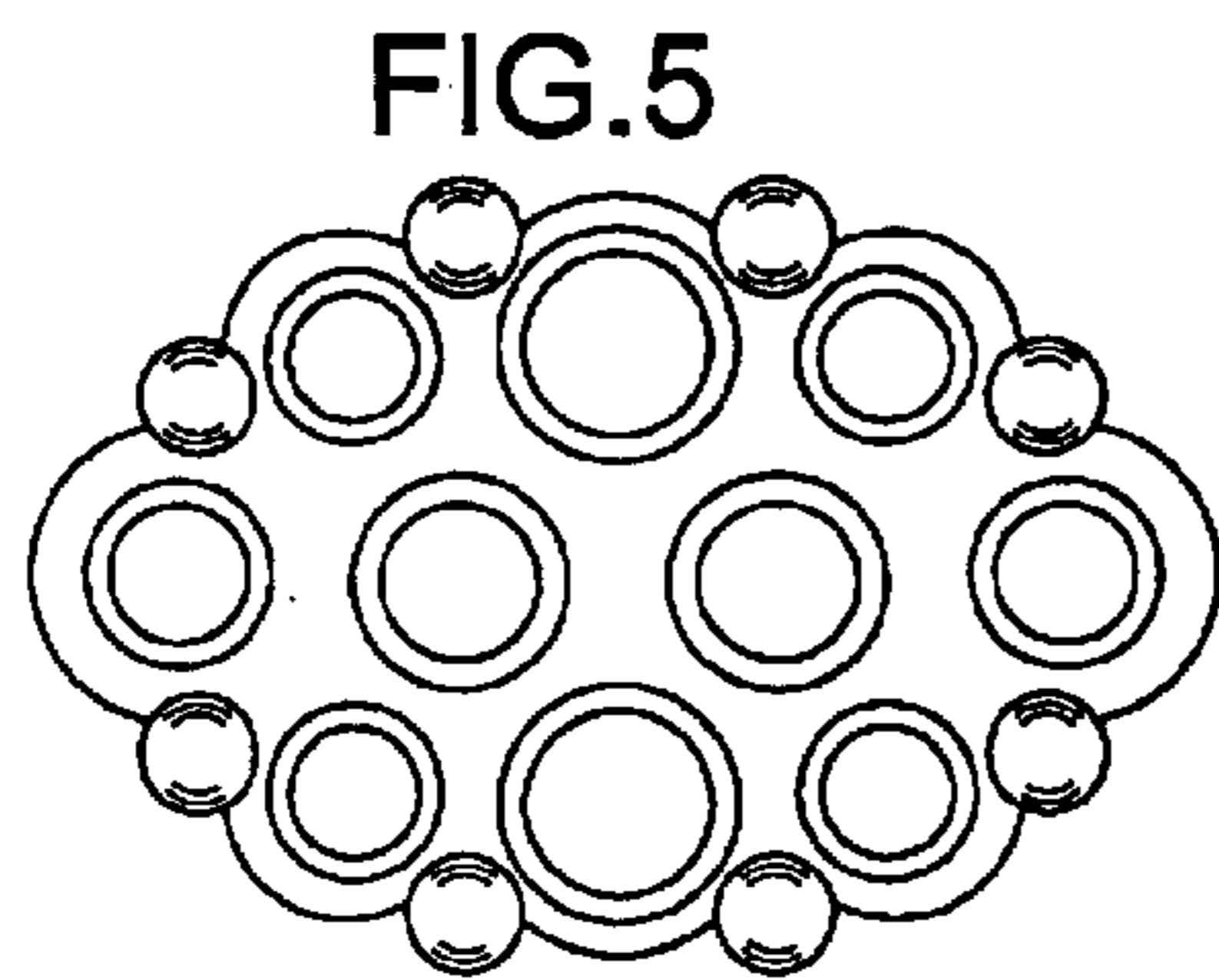

FIG. 5

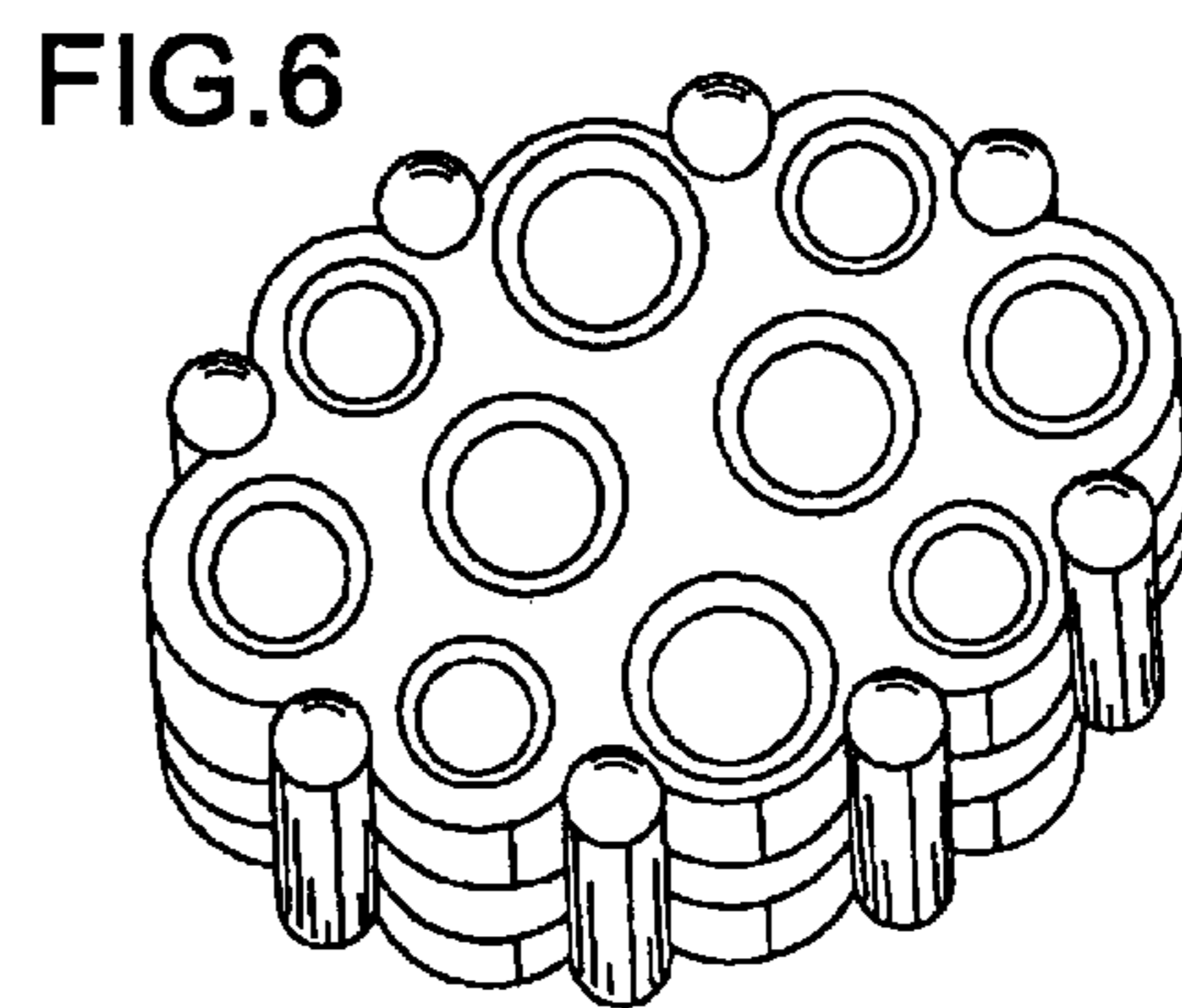

FIG. 6