

US00D505071S

(12) **United States Design Patent** (10) **Patent No.:** **US D505,071 S**
Mansau (45) **Date of Patent:** **** May 17, 2005**

(54) **BOTTLE CAP**

(75) Inventor: **Serge Mansau**, Bouloone (FR)

(73) Assignee: **Salvatore Ferragamo Italia S.p.A.**,
Florence (IT)

(**) Term: **14 Years**

(21) Appl. No.: **29/183,219**

(22) Filed: **Jun. 10, 2003**

(30) **Foreign Application Priority Data**

Dec. 11, 2002 (IT) FI2002O0090

(51) **LOC (7) Cl.** **09-07**

(52) **U.S. Cl.** **D9/435; D9/443**

(58) **Field of Search** D9/545, 435, 443,
D9/558; D28/91.1; 215/6, 200

(56) **References Cited**

U.S. PATENT DOCUMENTS

- 4,054,220 A * 10/1977 Rosenstein 215/6
D339,071 S * 9/1993 Mansau D9/558
D342,903 S * 1/1994 Ricci D9/545
D428,213 S * 7/2000 De Baschmakoff D28/91.1

* cited by examiner

Primary Examiner—Louis S. Zarfes

Assistant Examiner—G. Andoll

(74) *Attorney, Agent, or Firm*—Finnegan, Henderson,
Farabow, Garrett & Dunner, LLP

(57) **CLAIM**

The ornamental design for a bottle cap, as shown and described.

DESCRIPTION

FIG. 1 is a top perspective view of a bottle cap according to the design;
FIG. 2 is a bottom perspective view of the cap of FIG. 1;
FIG. 3 is a front-side view of the cap of FIG. 1, the view from the opposite side being a mirror image thereof;
FIG. 4 is a side view of the cap of FIG. 1, the view from the opposite side being a mirror image thereof;
FIG. 5 is a top plan view of the cap of FIG. 1;
FIG. 6 is a bottom plan view of the cap of FIG. 1;
FIG. 7 is a top perspective view of a second embodiment of the bottle cap of FIG. 1 made of an opaque material;
FIG. 8 is a bottom perspective view of the cap FIG. 7;
FIG. 9 is a front-side view of the cap of FIG. 7, the view from the opposite side being a mirror image thereof;
FIG. 10 is a side view of the cap of FIG. 7, view from the opposite side being a mirror image thereof;
FIG. 11 is a top plan view of the cap of FIG. 7; and
FIG. 12 is a bottom plan view of the cap of FIG. 7.
The bottle cap is made of transparent or non-transparent, glass, metal or plastic material.

1 Claim, 4 Drawing Sheets

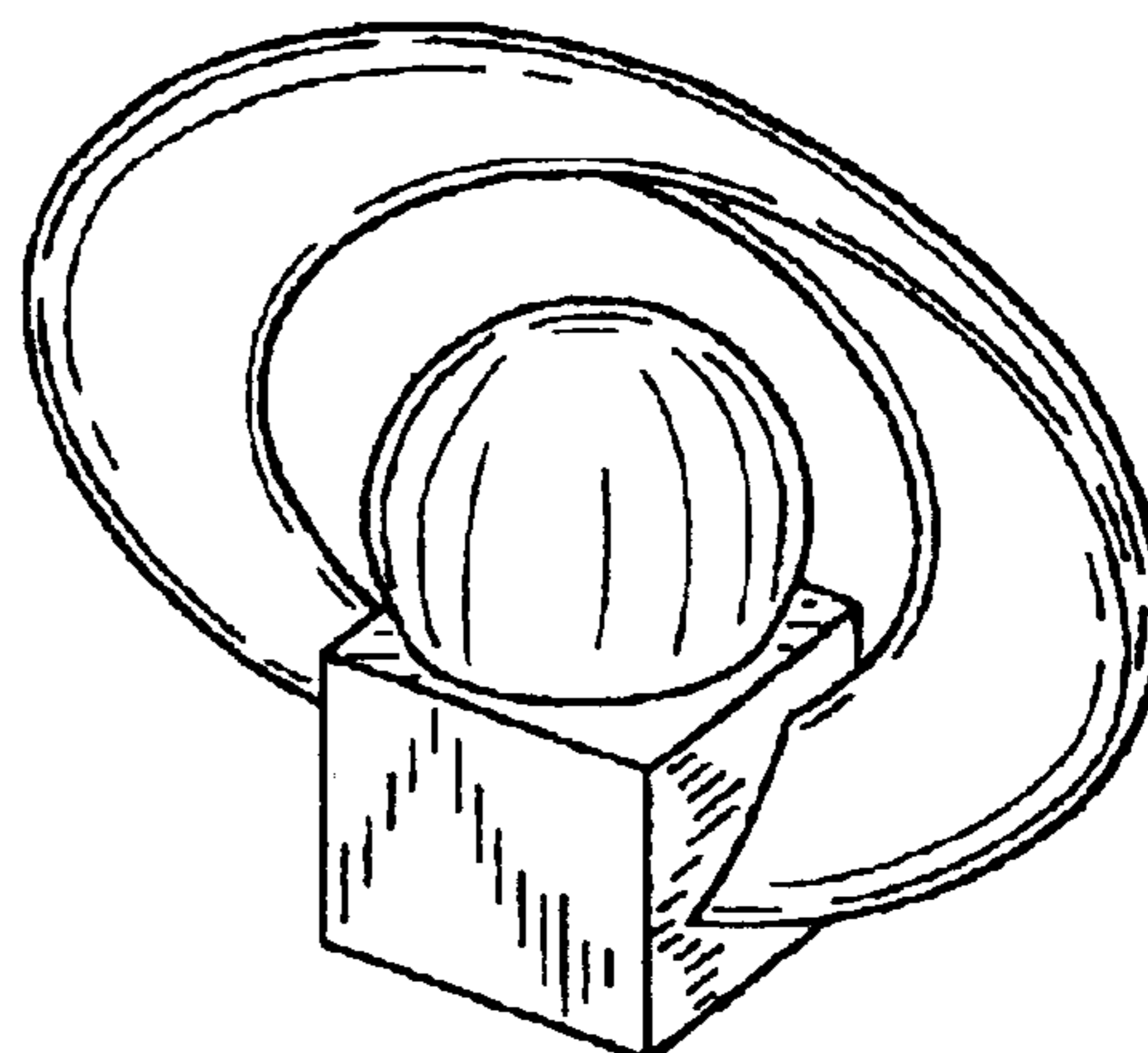
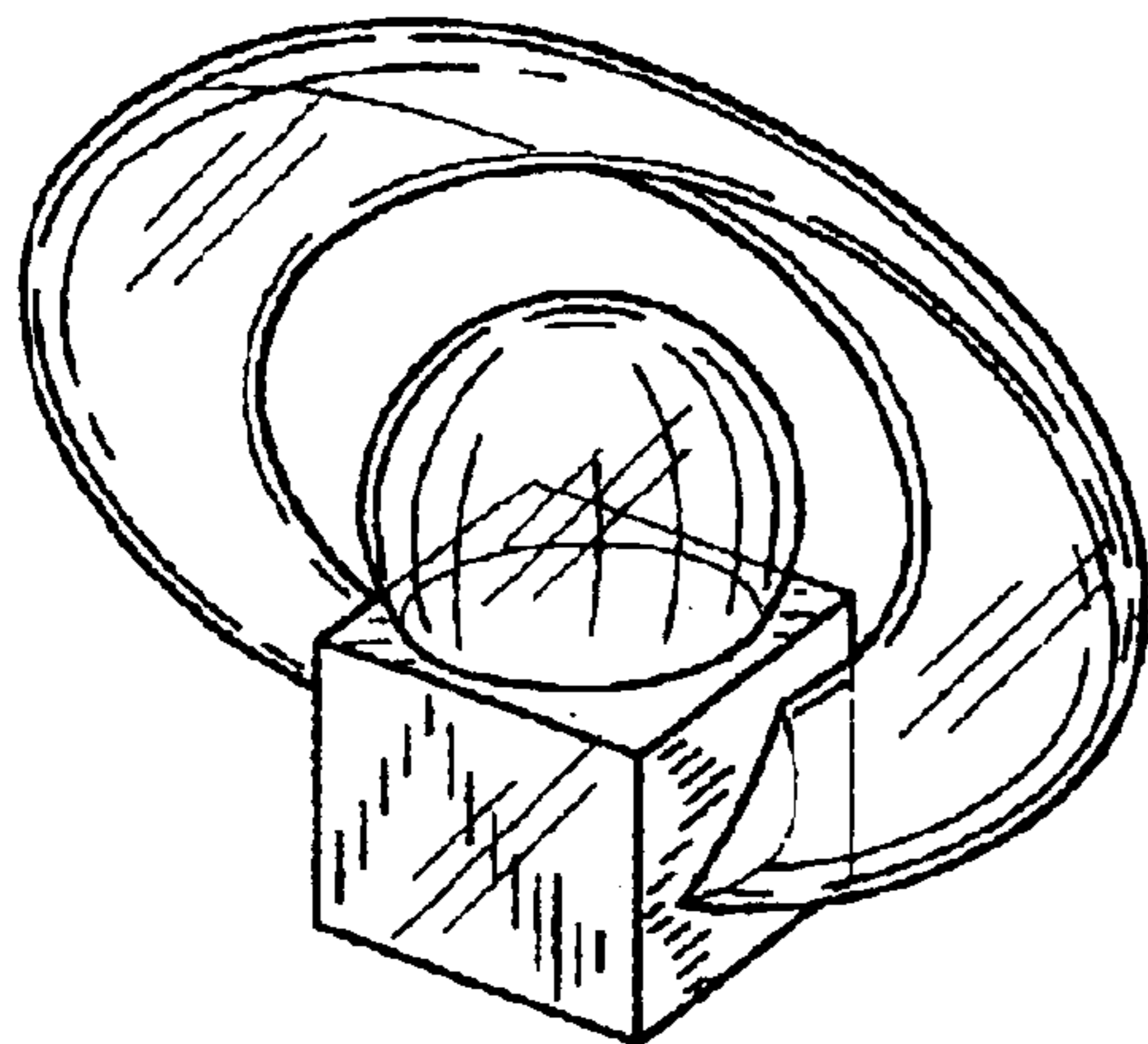

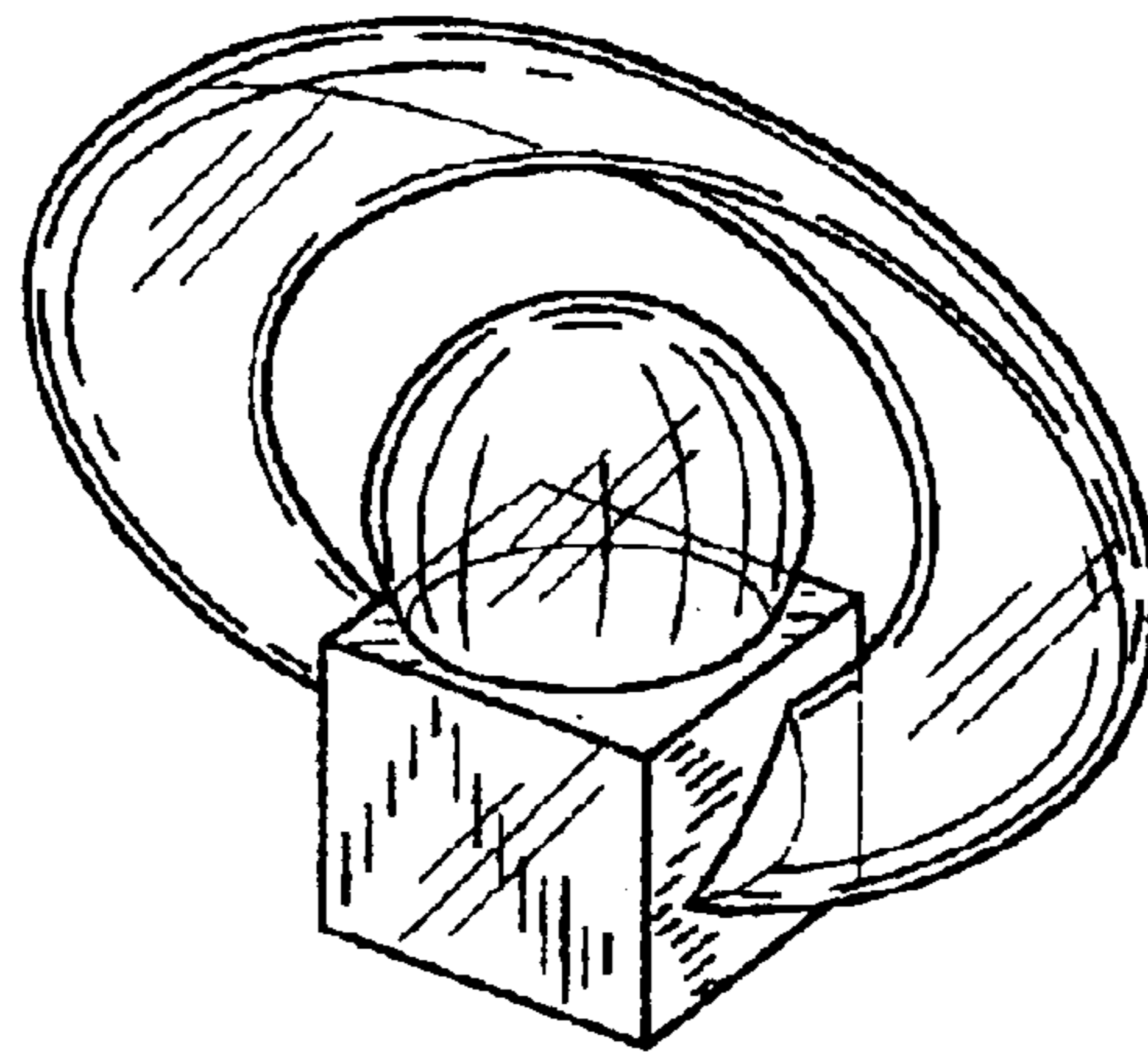

FIG. 1

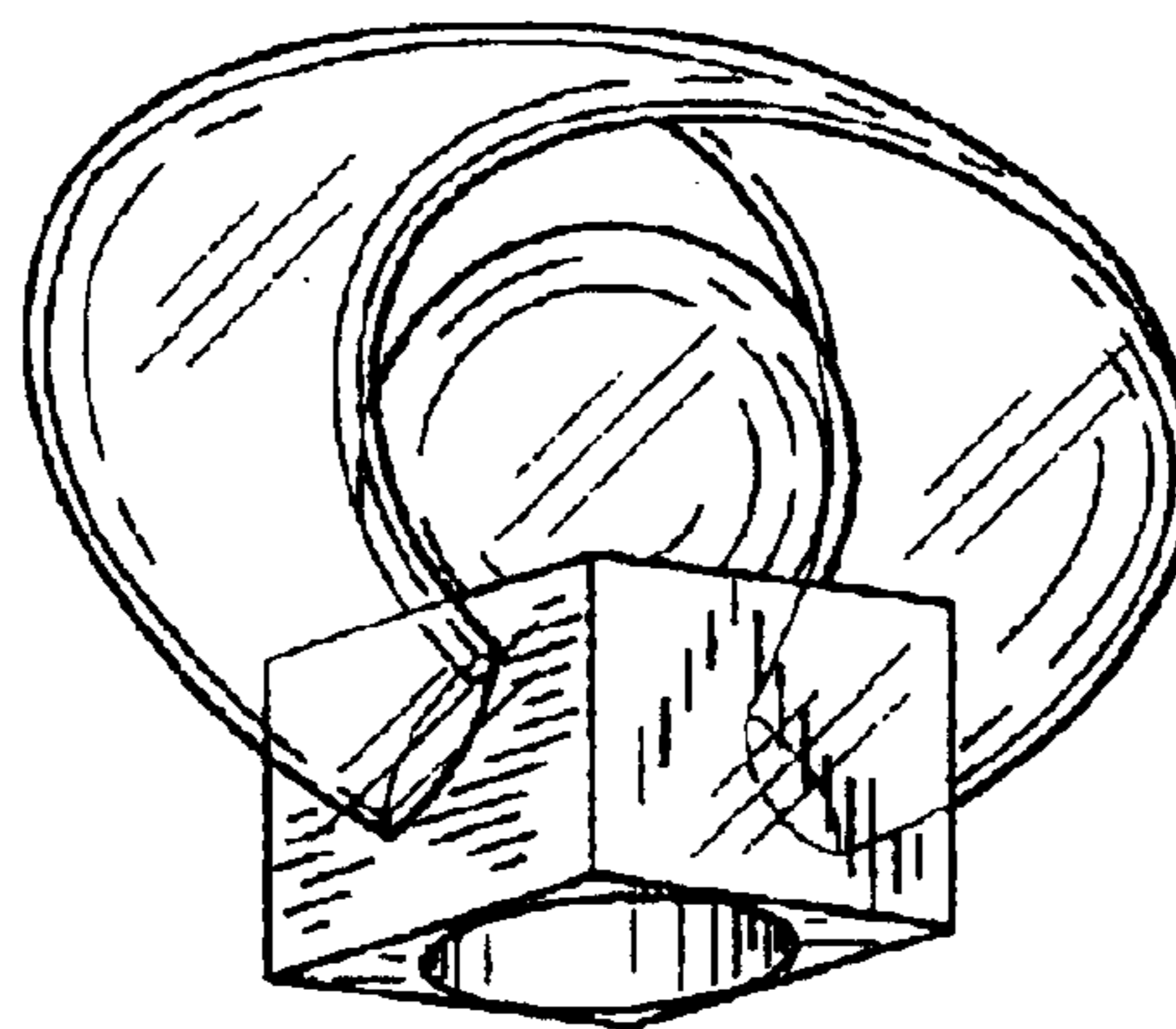

FIG. 2

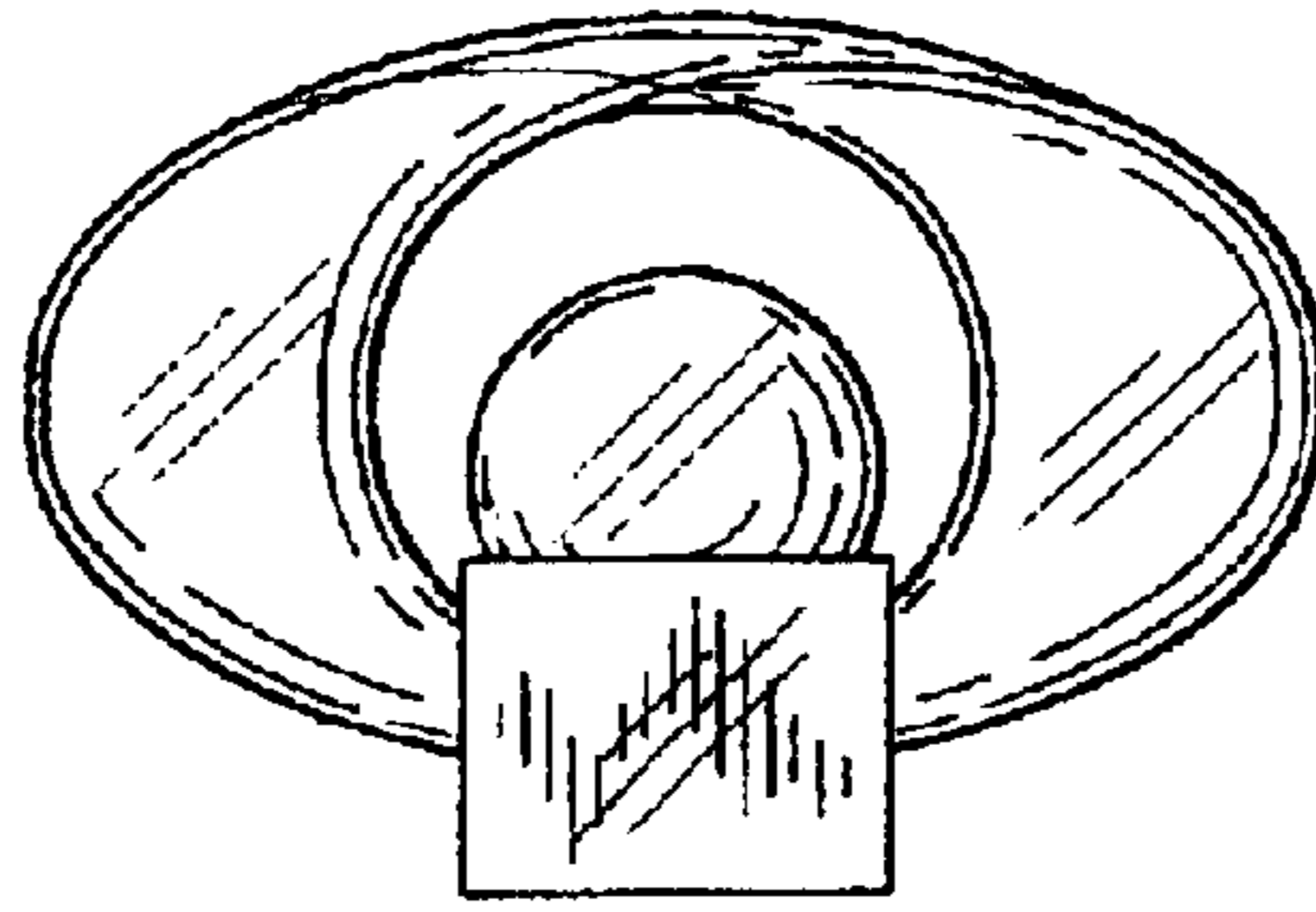

FIG. 3

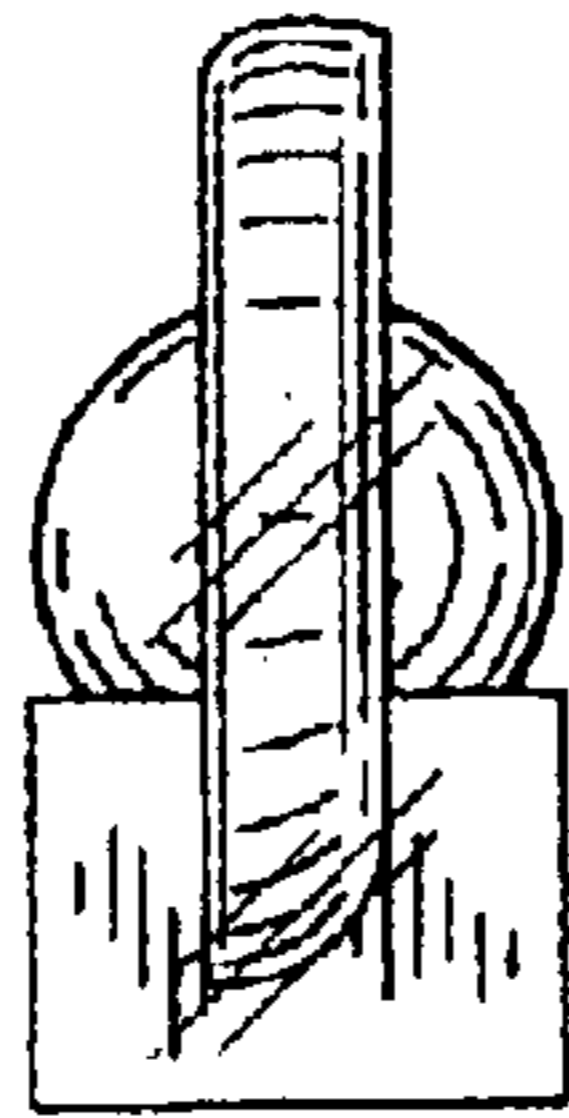

FIG. 4

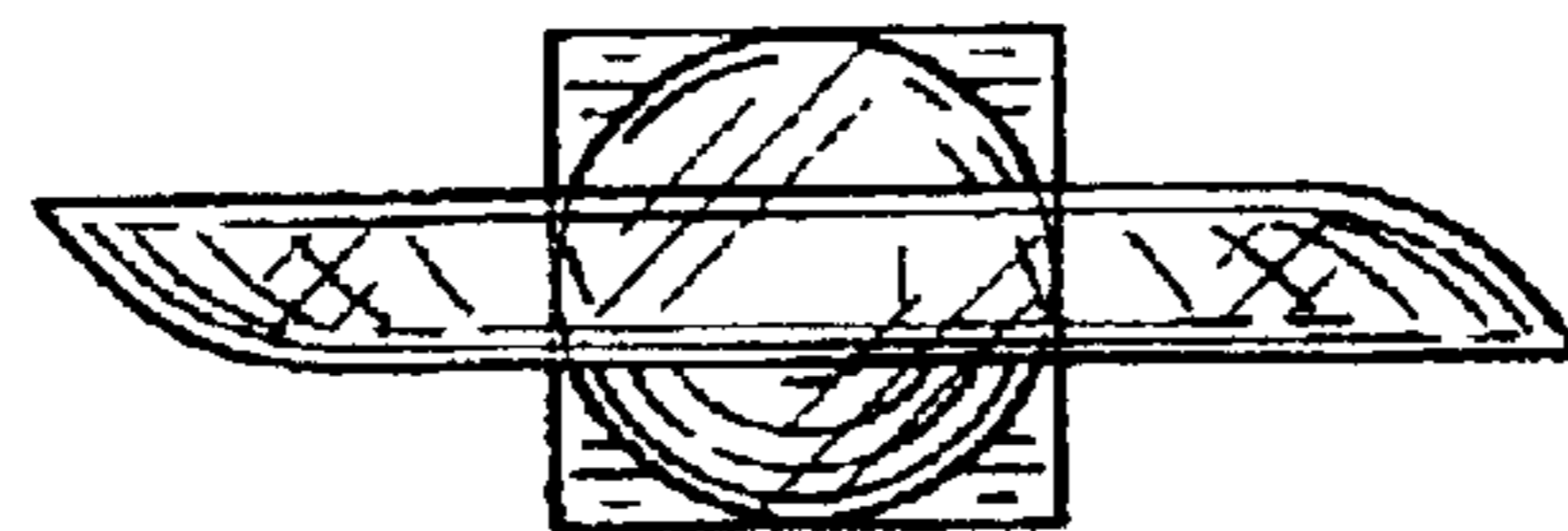

FIG. 5

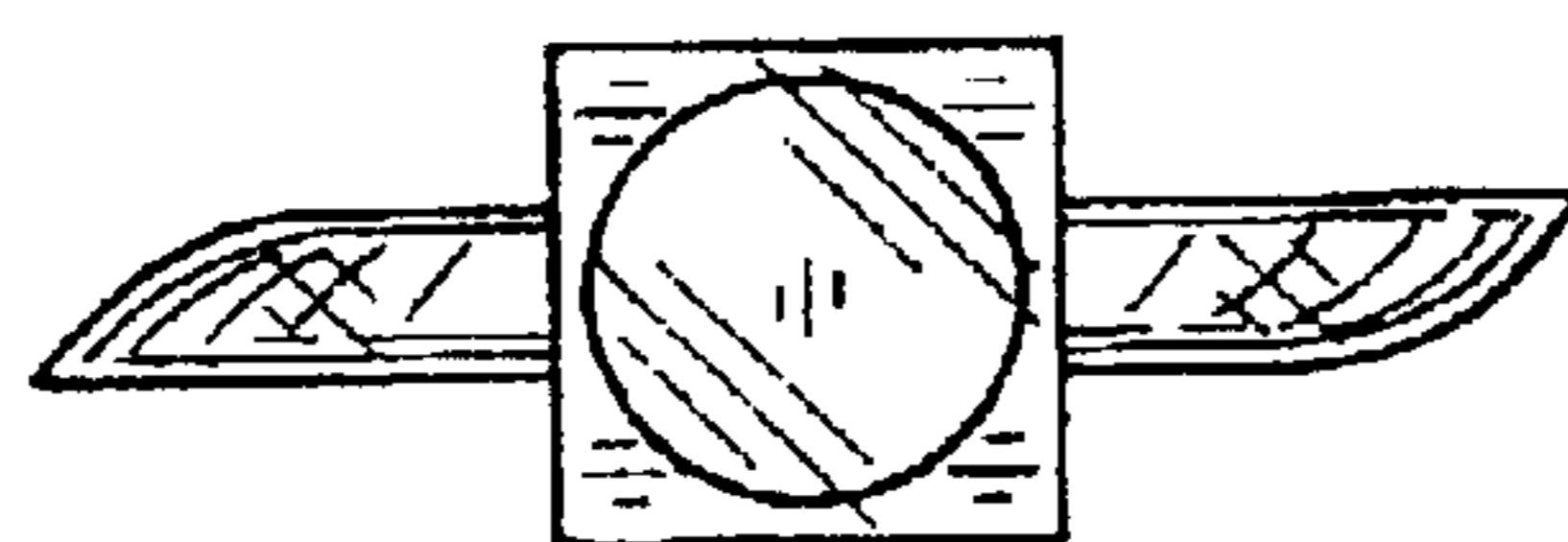

FIG. 6

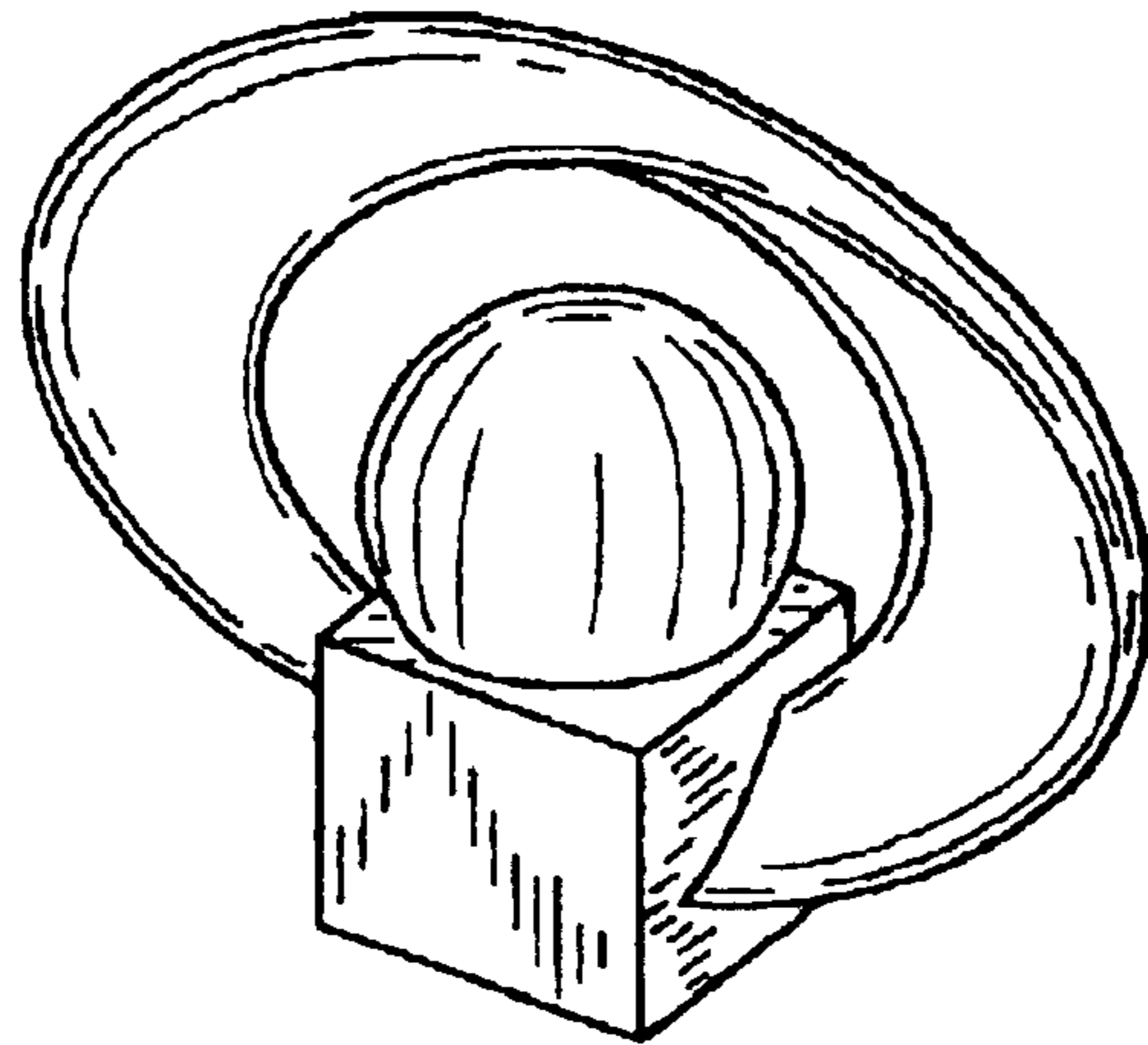

FIG. 7

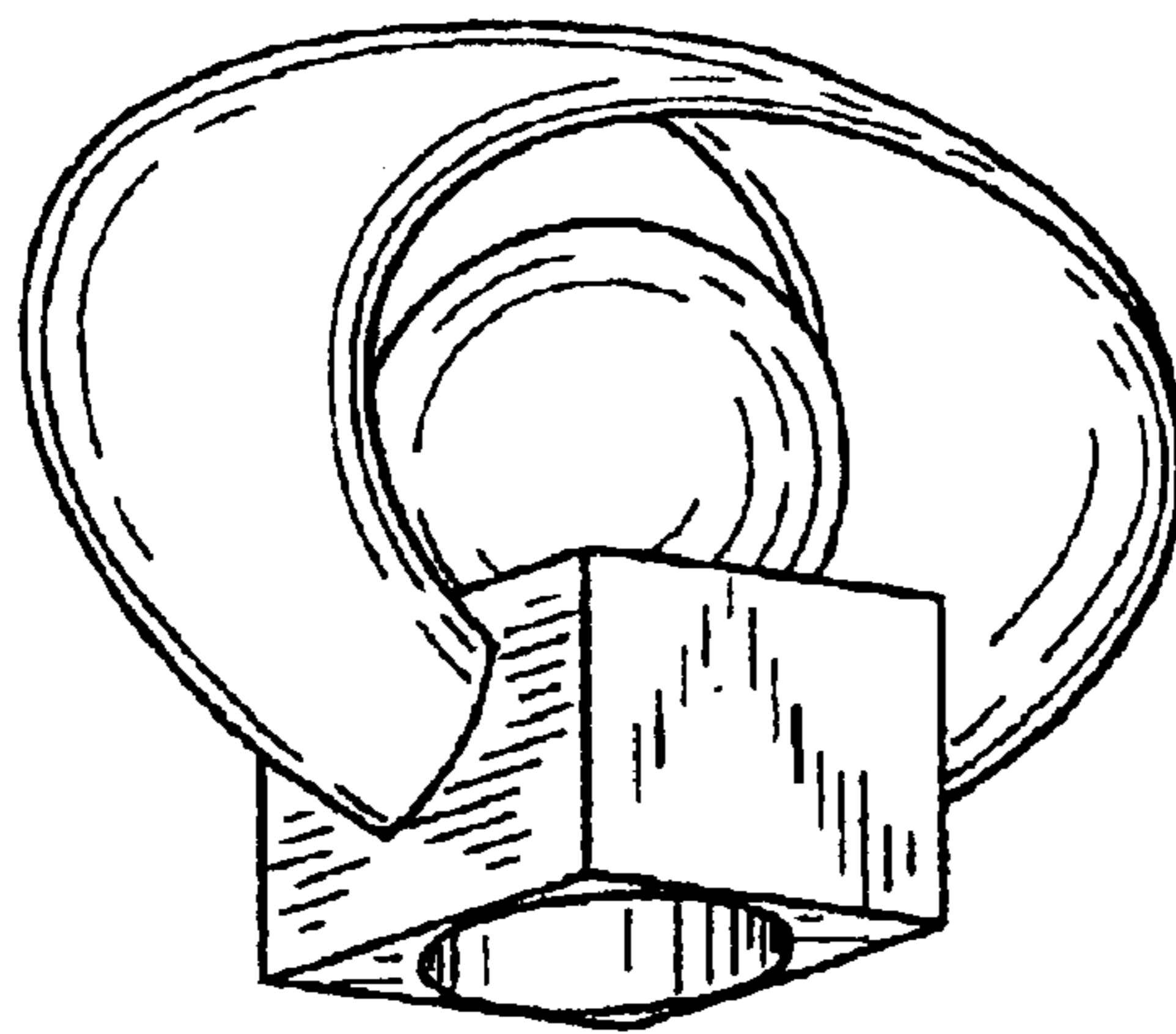

FIG. 8

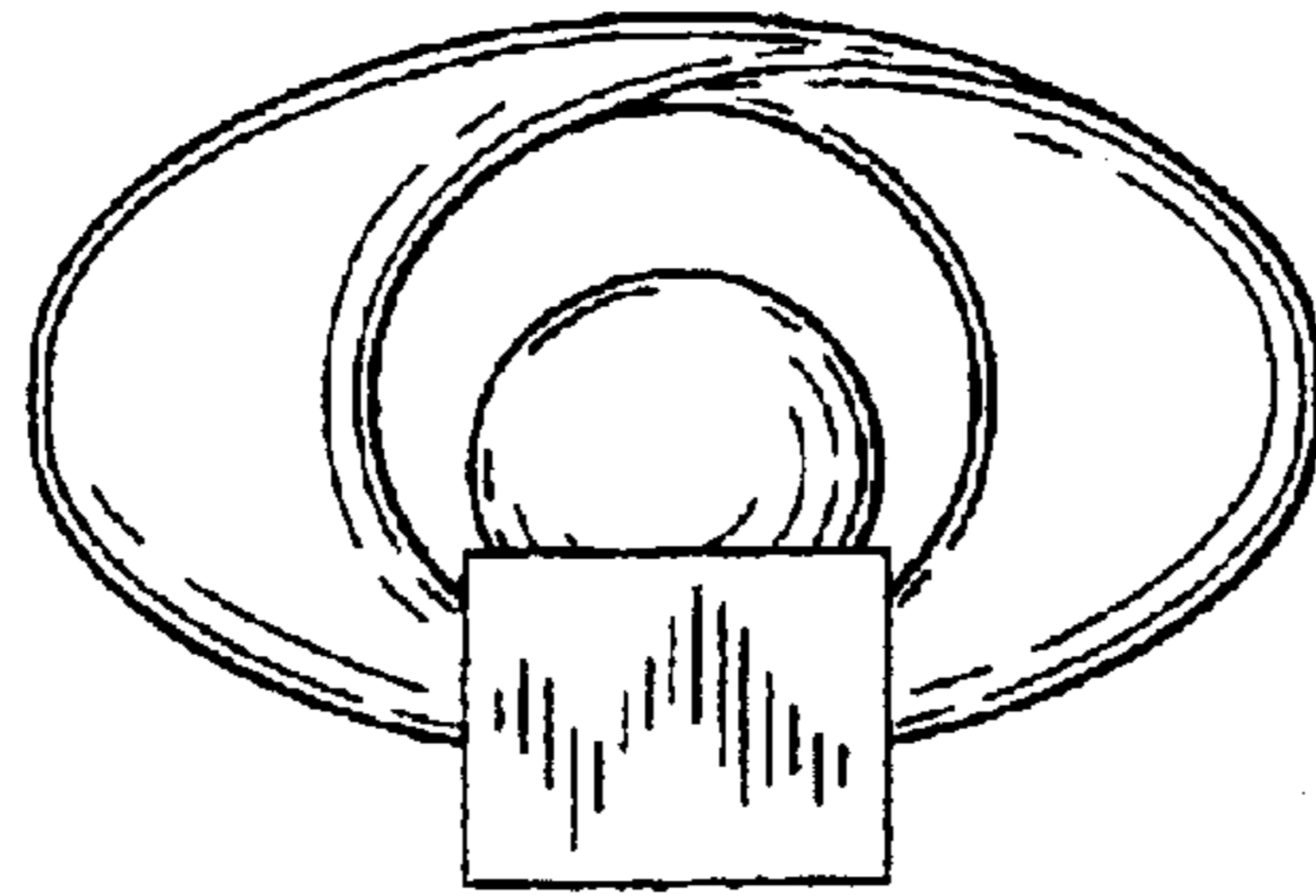

FIG. 9

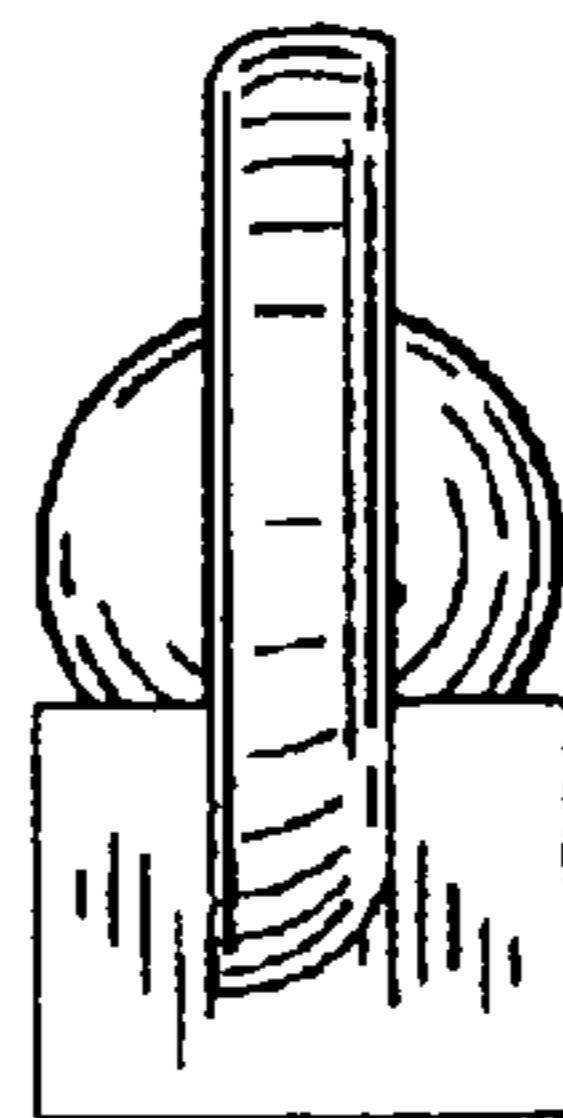

FIG. 10

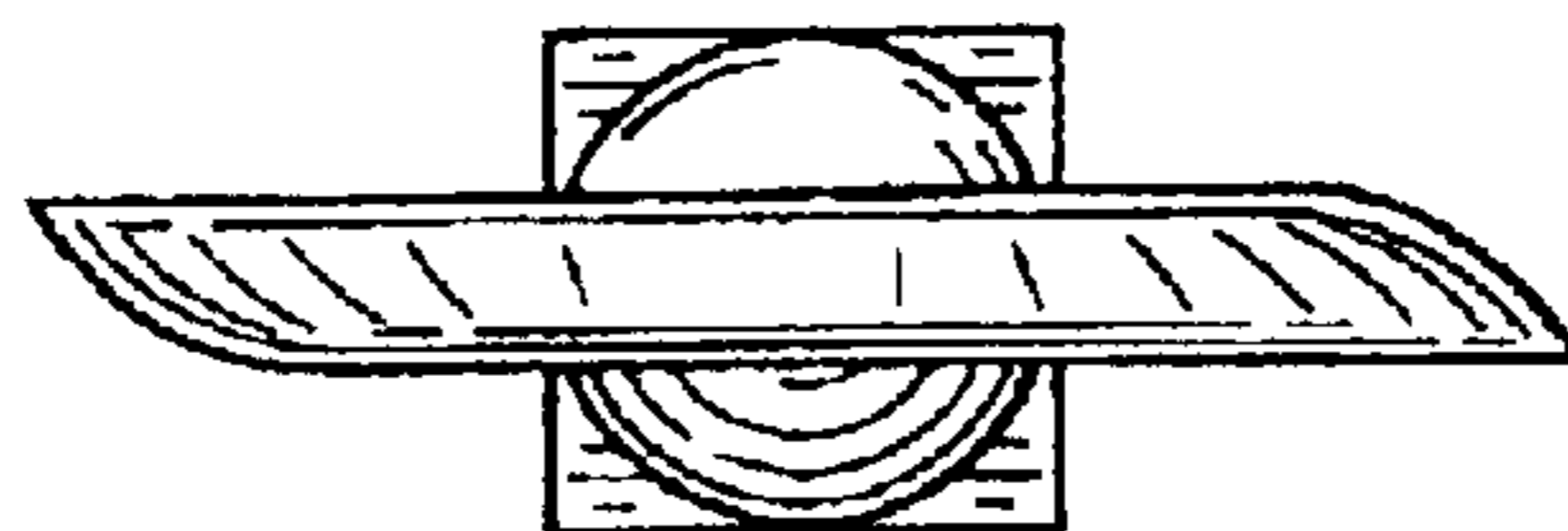

FIG. 11

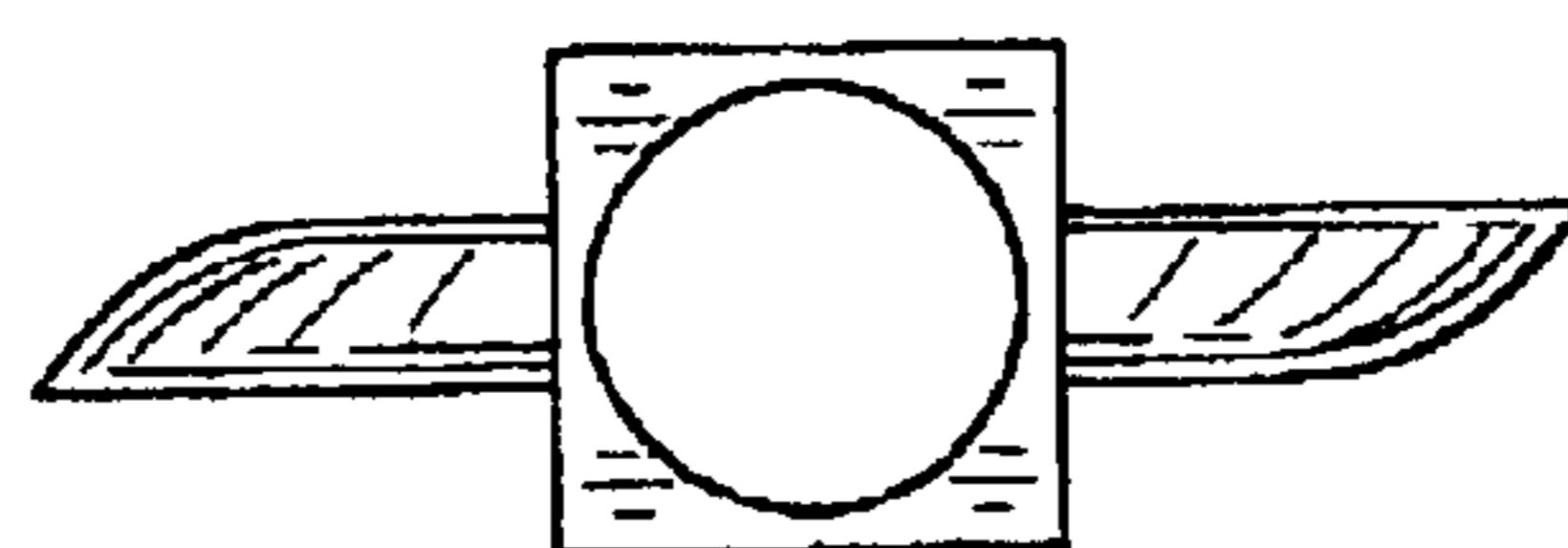

FIG. 12