



US00D505033S

(12) **United States Design Patent** (10) **Patent No.:** **US D505,033 S**
Cude (45) **Date of Patent:** **** May 17, 2005**

(54) **HEAD REST WITH MIRROR**

(76) **Inventor:** **R. Norman Cude**, 1869 Salem Bluff Dr., Winston Salem, NC (US) 27127

(**) **Term:** **14 Years**

(21) **Appl. No.:** **29/215,312**

(22) **Filed:** **Oct. 18, 2004**

(51) **LOC (7) Cl.** **06-06**

(52) **U.S. Cl.** **D6/501**

(58) **Field of Search** D6/334, 335, 356, D6/500-502; 297/391, 394, 397, 185, 220; D12/400; 248/118; 359/838, 871, 872, 879-881; 362/492

(56) **References Cited**

U.S. PATENT DOCUMENTS

3,905,642	A	*	9/1975	Simjian	297/185
4,557,520	A	*	12/1985	Simjian	297/185
4,702,519	A	*	10/1987	Lobanoff	297/185
D353,497	S	*	12/1994	Bergkvist et al.	D6/356
D436,271	S	*	1/2001	Corti	D6/501
6,283,622	B1	*	9/2001	Chupp et al.	362/492
D468,917	S	*	1/2003	Veneruso	D6/356
D471,369	S	*	3/2003	Khavari	D6/356
6,601,804	B2	*	8/2003	Bisch	297/391
6,773,123	B1	*	8/2004	Hatchett	359/872
D498,097	S	*	11/2004	Schwyzler	D6/501

2002/0135911	A1	*	9/2002	Glasow	359/880
2002/0185573	A1	*	12/2002	Bisch	248/118
2003/0030924	A1	*	2/2003	Takahashi	359/871
2003/0234567	A1	*	12/2003	O'Connor	297/391
2004/0179282	A1	*	9/2004	Kane	359/879
2004/0190167	A1	*	9/2004	Berger	359/879

* cited by examiner

Primary Examiner—Mimosa De

(57) **CLAIM**

The ornamental design for a head rest with mirror, as shown and described.

DESCRIPTION

FIG. 1 is a front, top, right side perspective view of the head rest with mirror embodying my design; FIG. 2 is a front elevational view thereof; FIG. 3 is a rear elevational thereof; FIG. 4 is a top plan view thereof, the bottom view being a mirror image thereof; FIG. 5 is a right side elevational view thereof, the left side elevational view being a mirror image thereof; FIG. 6 is a cross sectional view taken along line 6—6 of FIG. 5 showing of the mirror; and, FIG. 7 is a cross sectional view taken along line 7—7 of FIG. 5 showing of the headrest.

1 Claim, 5 Drawing Sheets

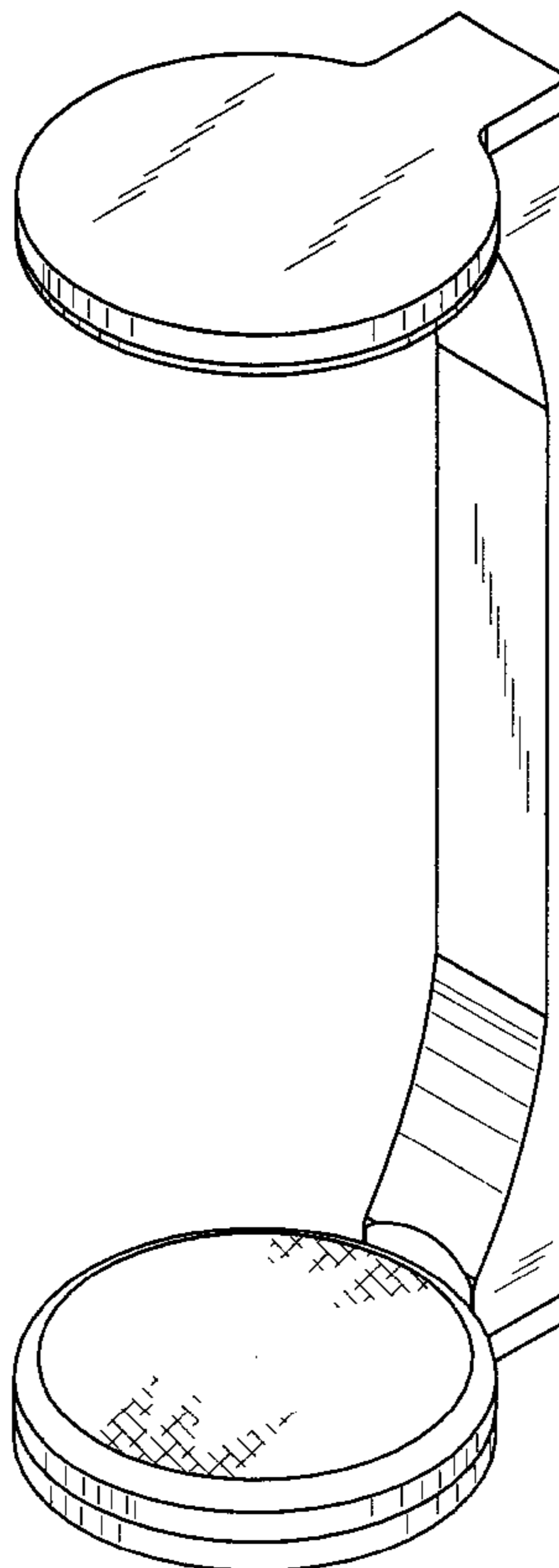

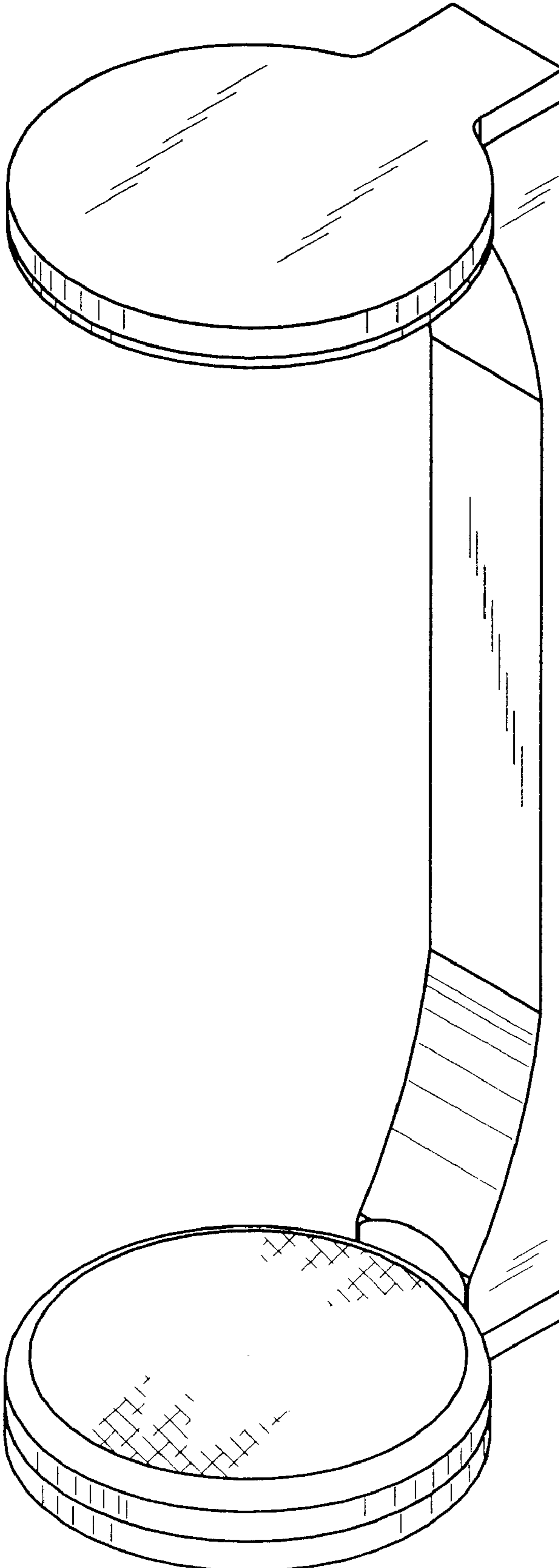

FIG. 1

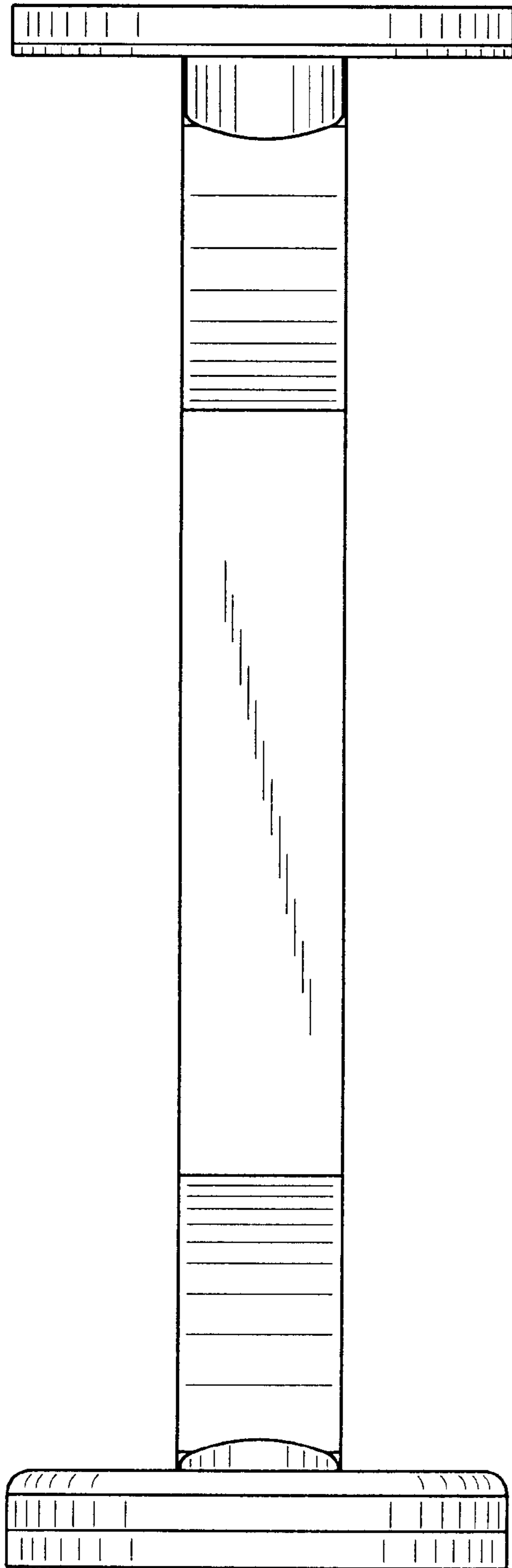

FIG. 2

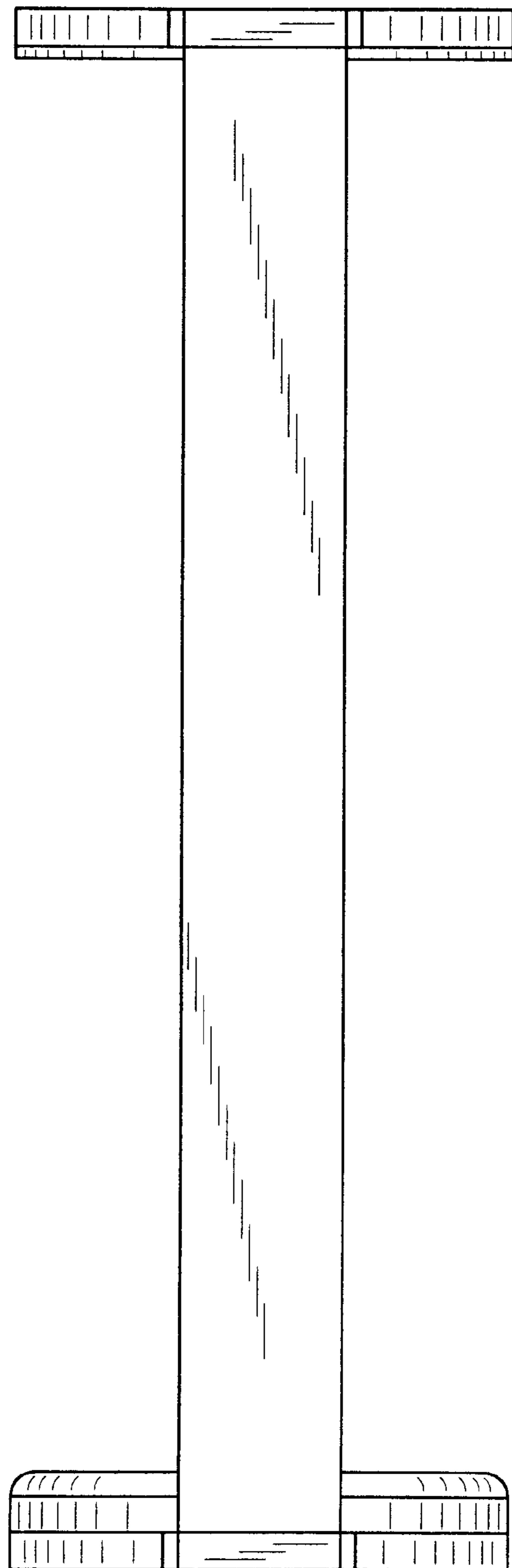

FIG. 3

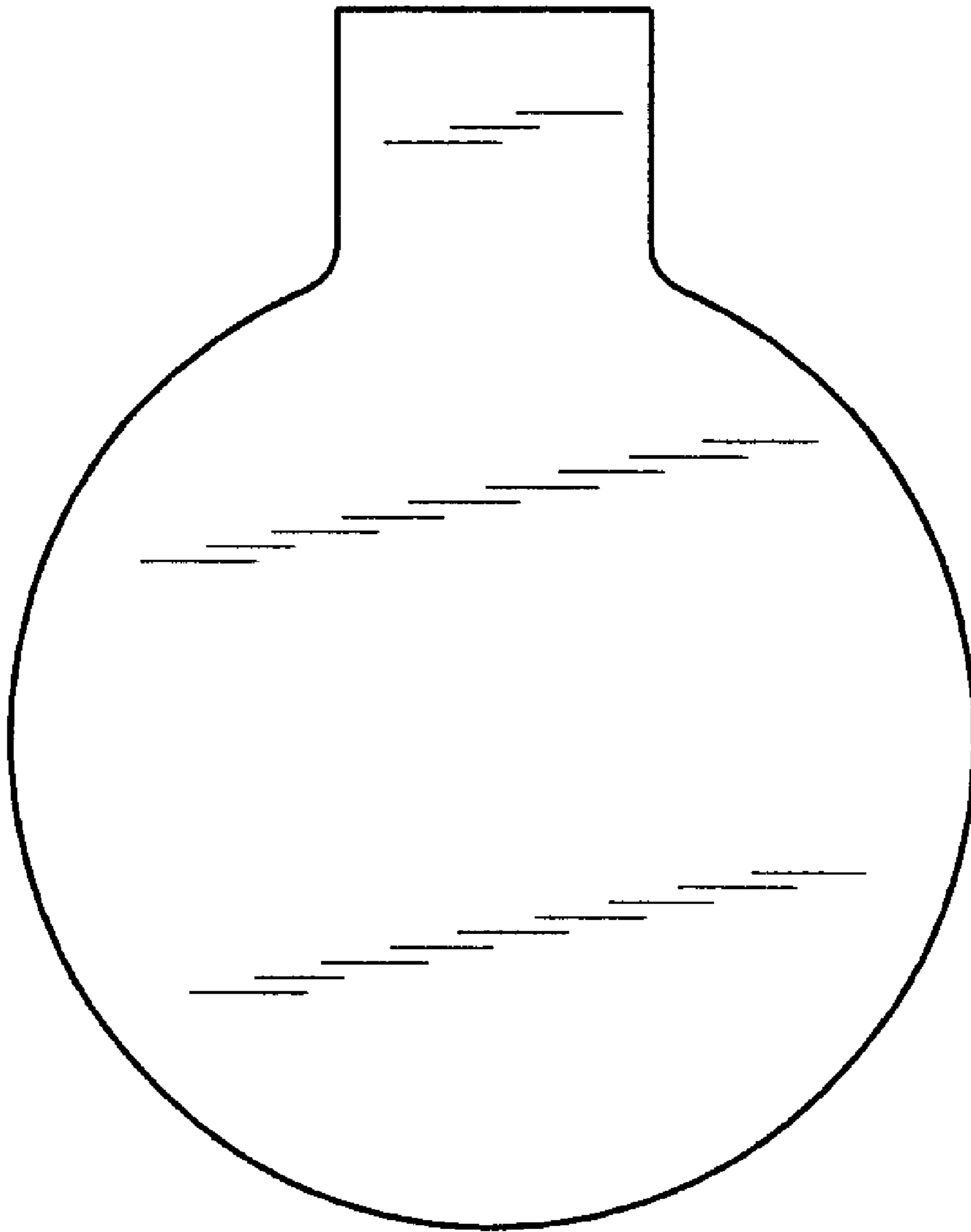

FIG. 4

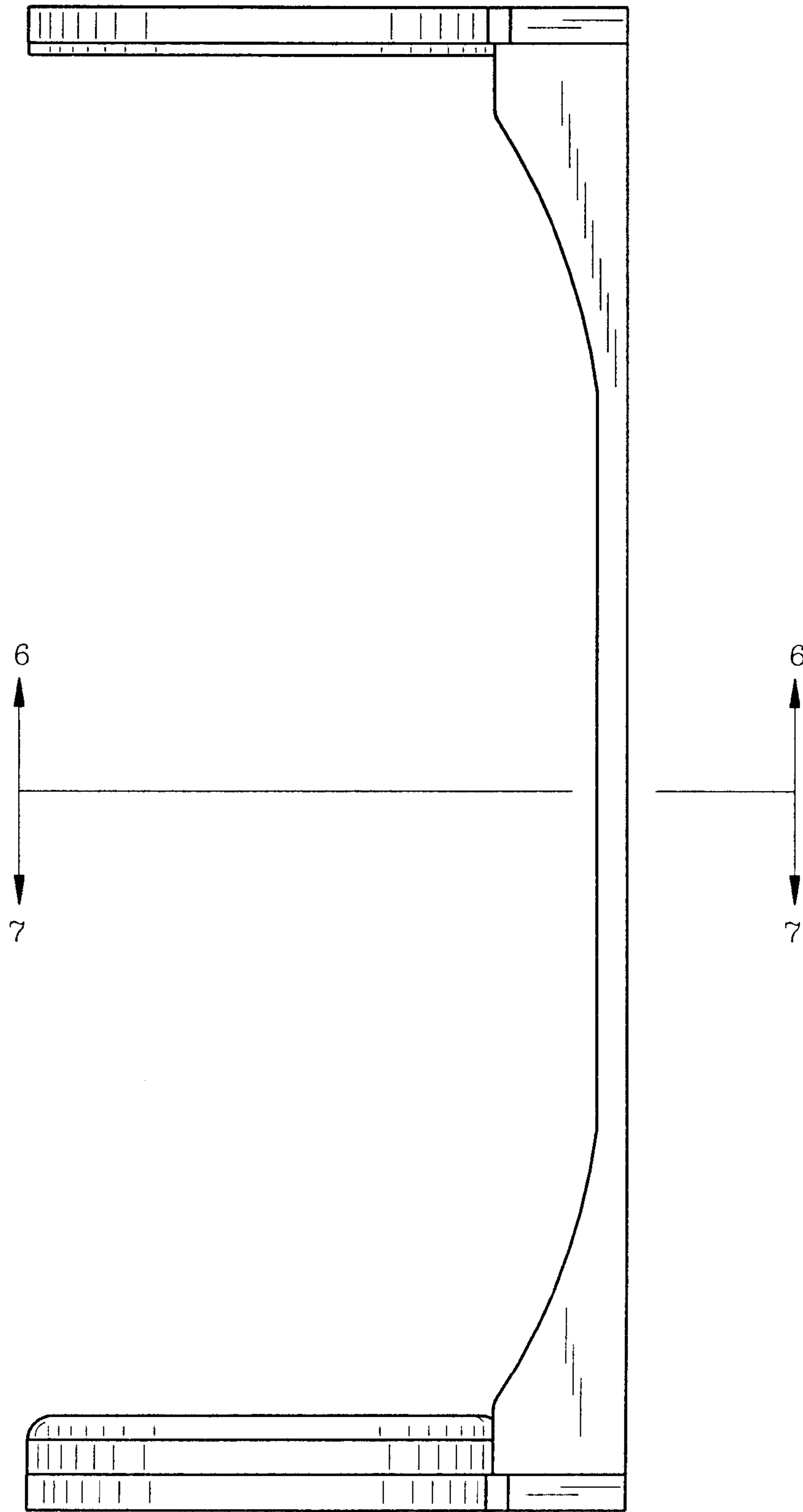

FIG. 5

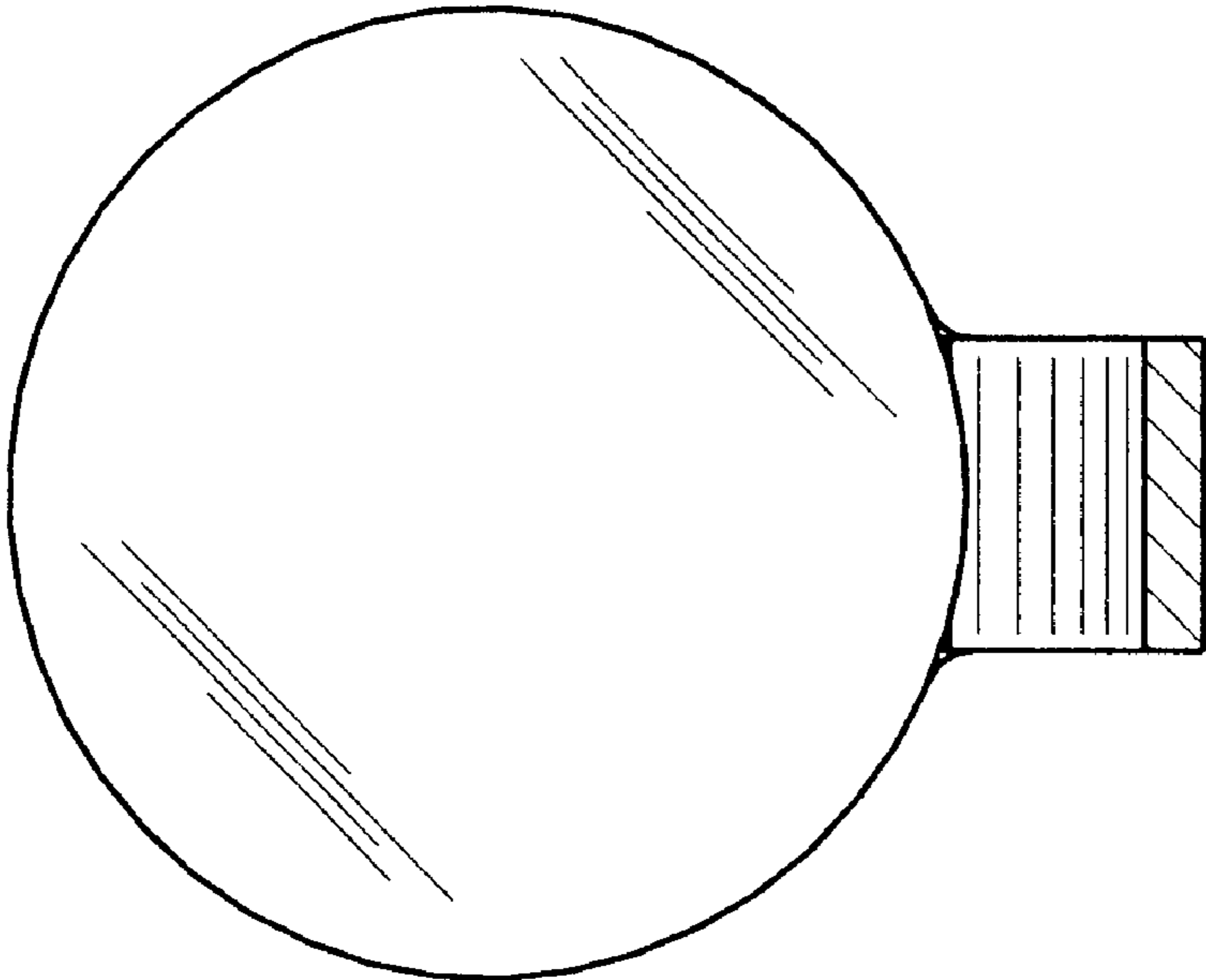

FIG. 6

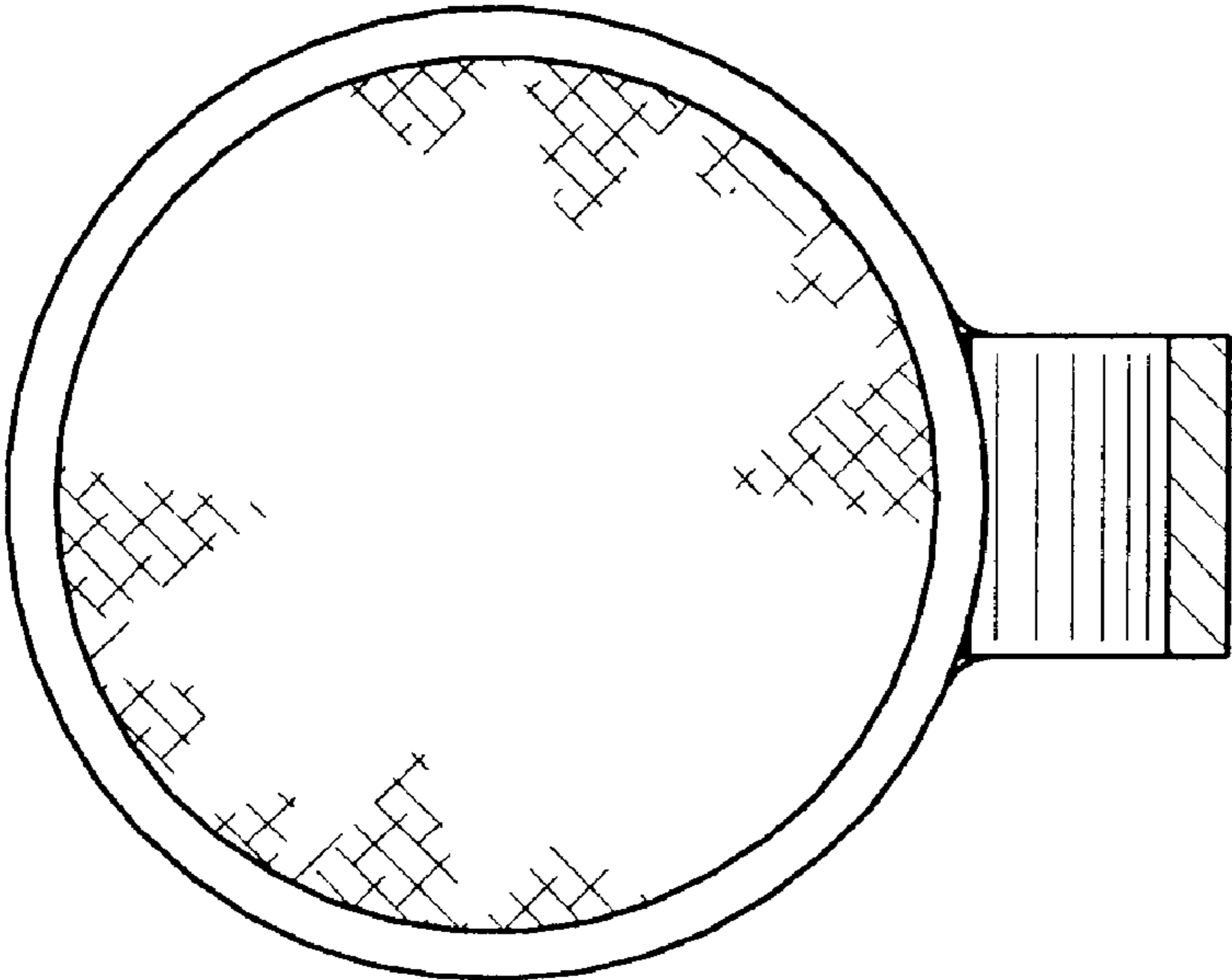

FIG. 7