



US00D504909S

(12) **United States Design Patent**  
**Banderet**

(10) **Patent No.: US D504,909 S**  
(45) **Date of Patent: \*\* May 10, 2005**

(54) **HIGHLIGHTER**

**DESCRIPTION**

(75) Inventor: **Philippe Banderet**, Chatuzange le Goubet (FR)

(73) Assignee: **Reynolds**, Valence (FR)

(\*\*) Term: **14 Years**

(21) Appl. No.: **29/194,817**

(22) Filed: **Dec. 2, 2003**

(30) **Foreign Application Priority Data**

Jun. 2, 2003 (FR) ..... 03 2910  
Nov. 4, 2003 (FR) ..... 03 5371

(51) **LOC (7) Cl.** ..... **19-06**

(52) **U.S. Cl.** ..... **D19/36; D19/43; D19/50**

(58) **Field of Search** ..... **D19/35, 36, 41-51, D19/53-58, 81-85; 401/6, 7, 88, 29-34, 196, 198, 202, 213, 260, 261, 262; D28/77**

(56) **References Cited**

**U.S. PATENT DOCUMENTS**

D229,446 S	*	11/1973	Dahl	.....	D19/46
D290,851 S	*	7/1987	Yoshida	.....	D19/41
4,702,633 A	*	10/1987	Schmidt	.....	401/34
4,902,151 A	*	2/1990	Assano et al.	.....	401/34
D312,659 S	*	12/1990	Oka	.....	D19/41
D321,905 S	*	11/1991	Tu	.....	D19/36
D322,811 S	*	12/1991	Isern	.....	D19/36
D338,741 S	*	8/1993	Cassai	.....	D19/36 X

\* cited by examiner

*Primary Examiner*—Martie K. Holtje

(74) *Attorney, Agent, or Firm*—Marshall, Gerstein & Borun LLP

(57) **CLAIM**

The ornamental design for a “highlighter,” as shown and described.

FIG. 1 is a front, bottom, and right side perspective view of a “highlighter” constructed in accordance with the teachings of the present invention;

FIG. 2 is a front view of the “highlighter” as shown in FIG. 1;

FIG. 3 is a rear view of the “highlighter” as shown in FIG. 1;

FIG. 4 is a top view of the “highlighter” as shown in FIG. 1;

FIG. 5 is a right side view of the “highlighter” as shown in FIG. 1, the left side view being a mirror image of the right side view;

FIG. 6 is a bottom view of the “highlighter” as shown in FIG. 1;

FIG. 7 is an exploded right side view of the “highlighter” as shown in FIG. 1, the left side view being a mirror image of the right side view;

FIG. 8 is an exploded right side view of the “highlighter” as shown in FIG. 1, except wherein the writing tip of the “highlighter” is shown in a reverse orientation, the left side view being a mirror image of the right side view;

FIG. 9 is a right side view of a second embodiment of the “highlighter” in FIG. 1, the left side view being a mirror image of the right side view;

FIG. 10 is a right side view of the “highlighter” as shown in FIG. 9, except wherein the writing tip of the “highlighter” is shown in a reverse orientation, the left side view being a mirror image of the right side view;

FIG. 11 is a right side view of the “highlighter” as shown in FIG. 10;

FIG. 12 is a bottom view of the “highlighter” as shown in FIG. 10;

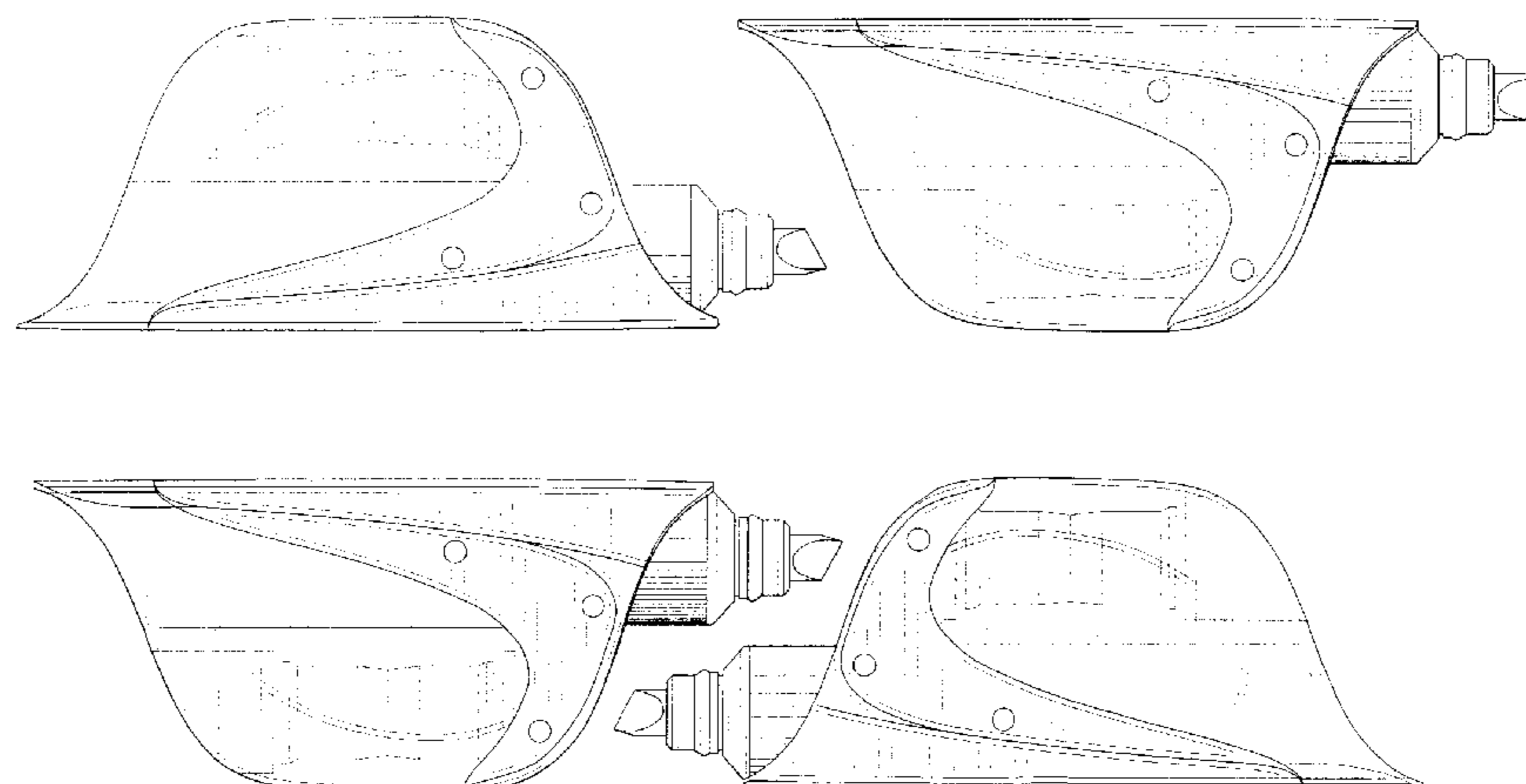
FIG. 13 is an exploded right side view of the “highlighter” as shown in FIG. 10;

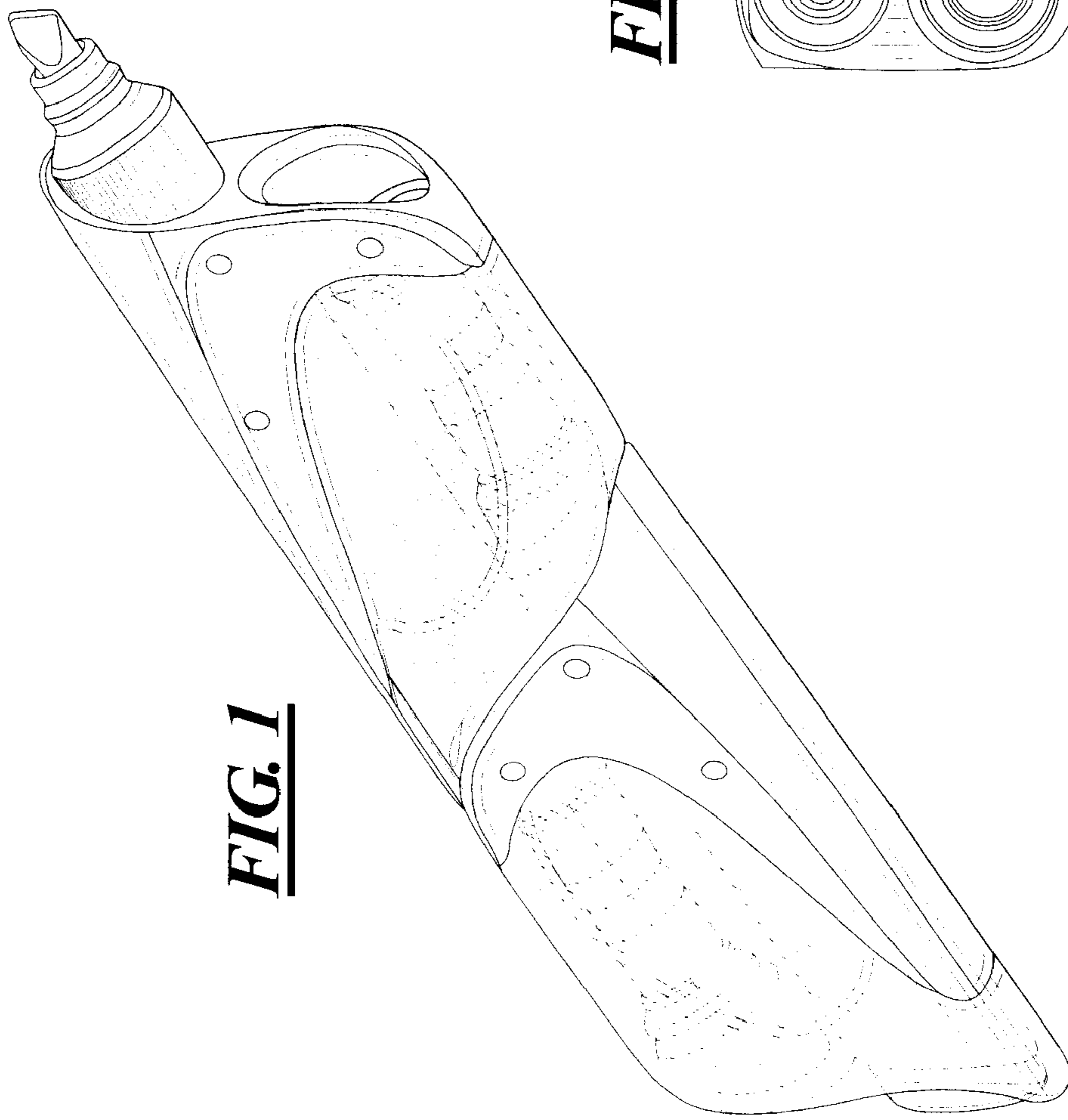
FIG. 14 is a top view of the “highlighter” as shown in FIG. 13;

FIG. 15 is a perspective view of the “highlighter” as shown in FIG. 13; and,

FIG. 16 is a perspective view of the “highlighter” as shown in FIG. 10.

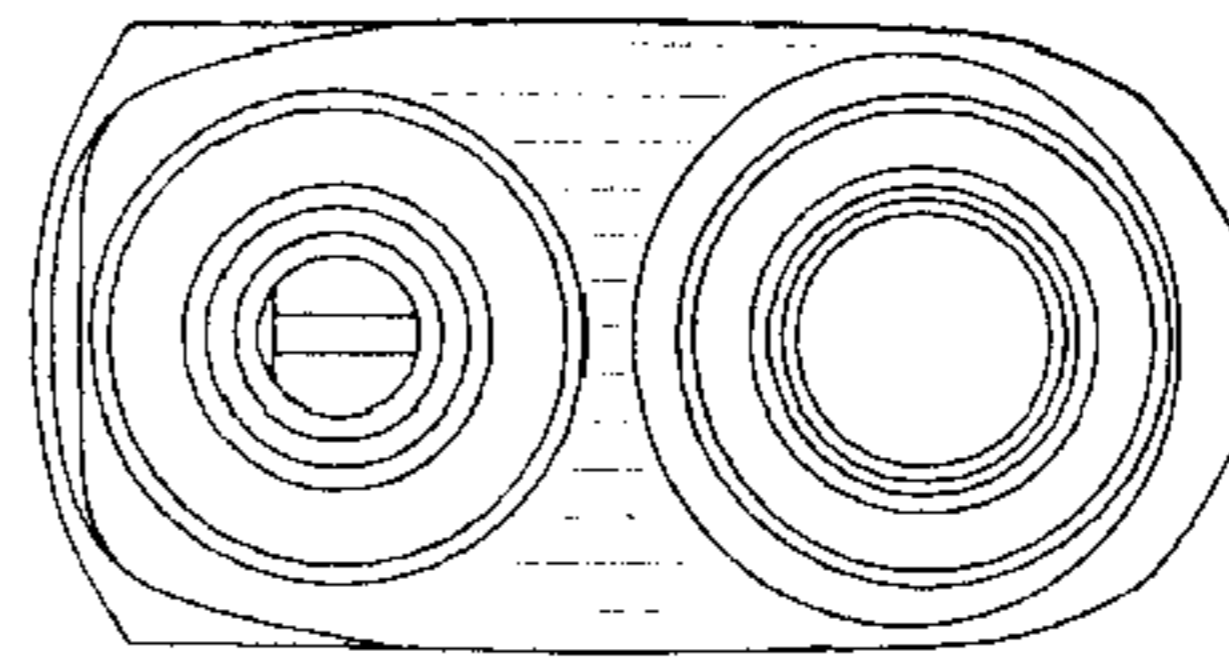
**1 Claim, 7 Drawing Sheets**



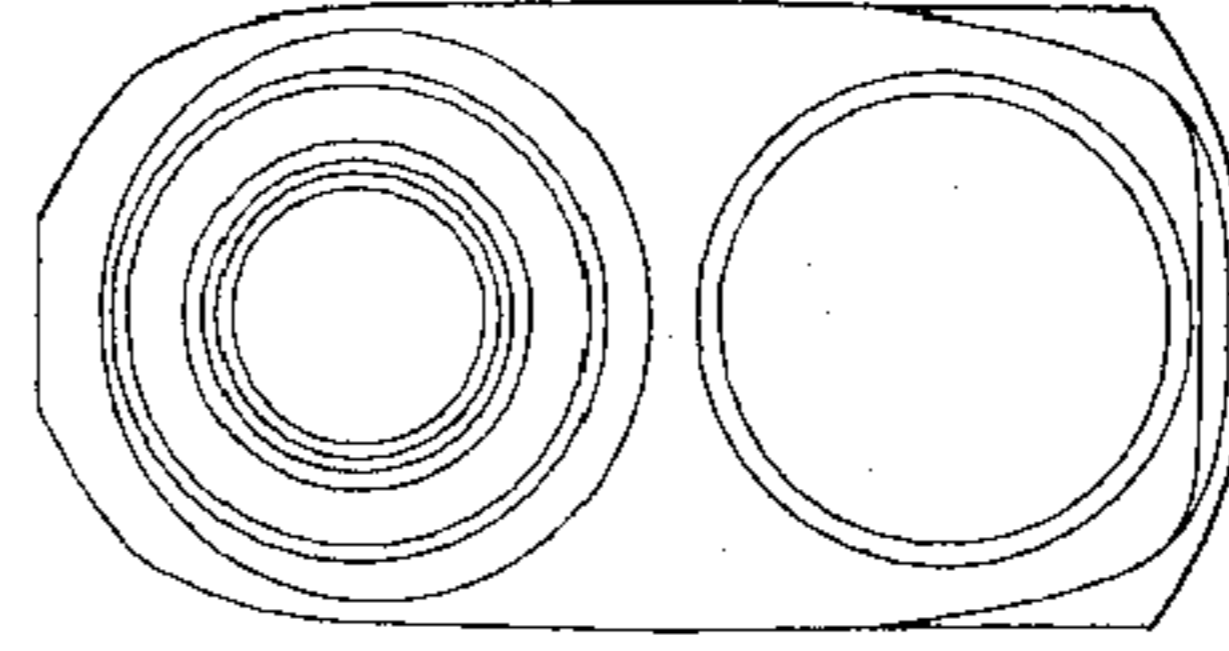


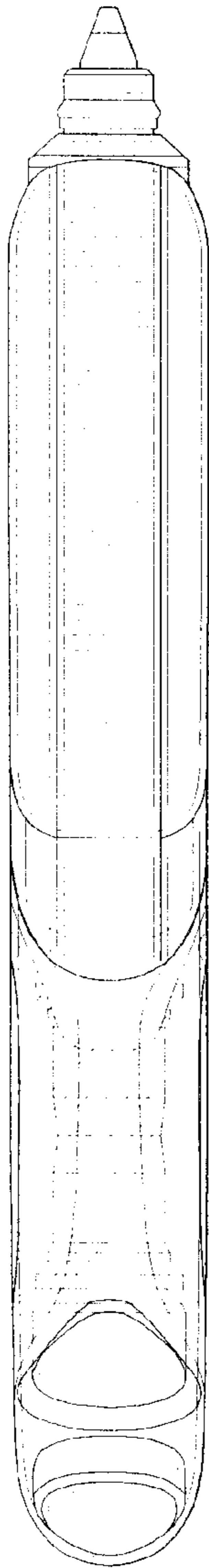
**FIG. 1**

**FIG. 2**

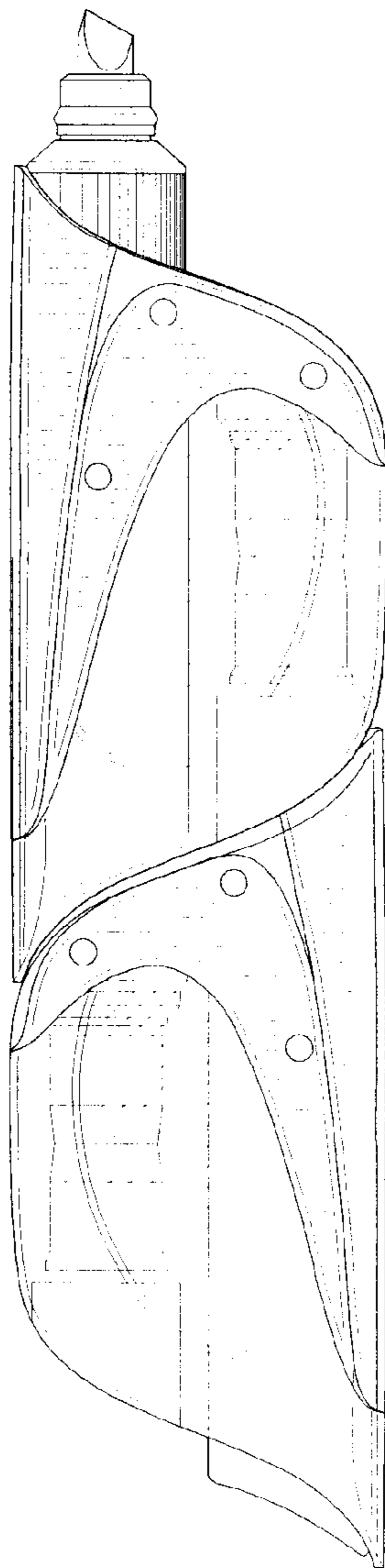


**FIG. 3**

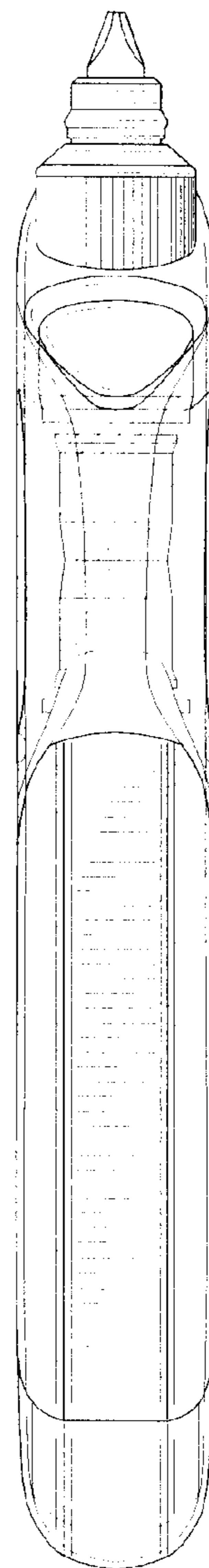




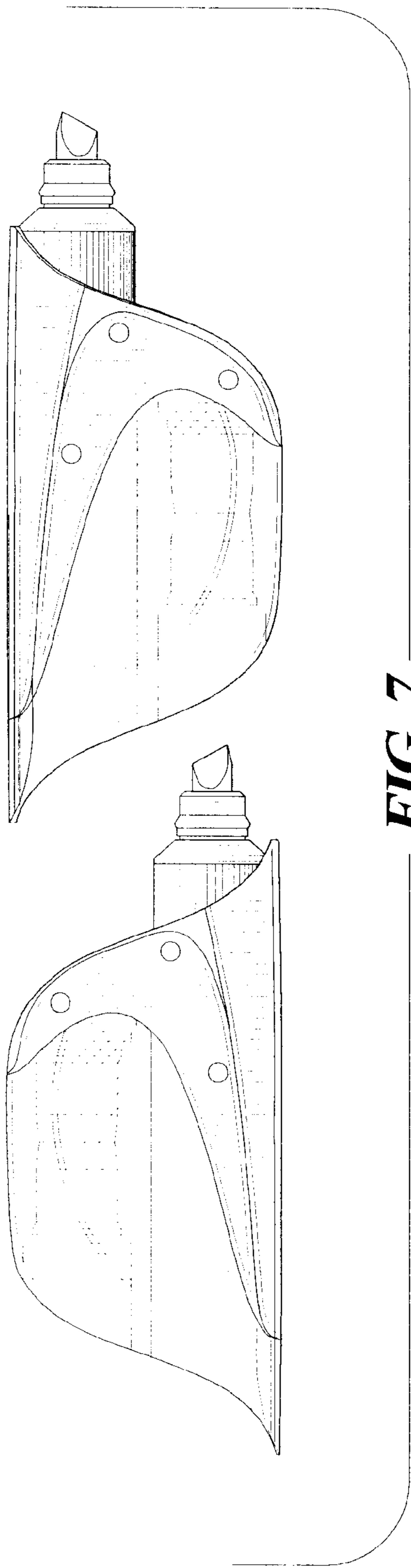
**FIG. 4**



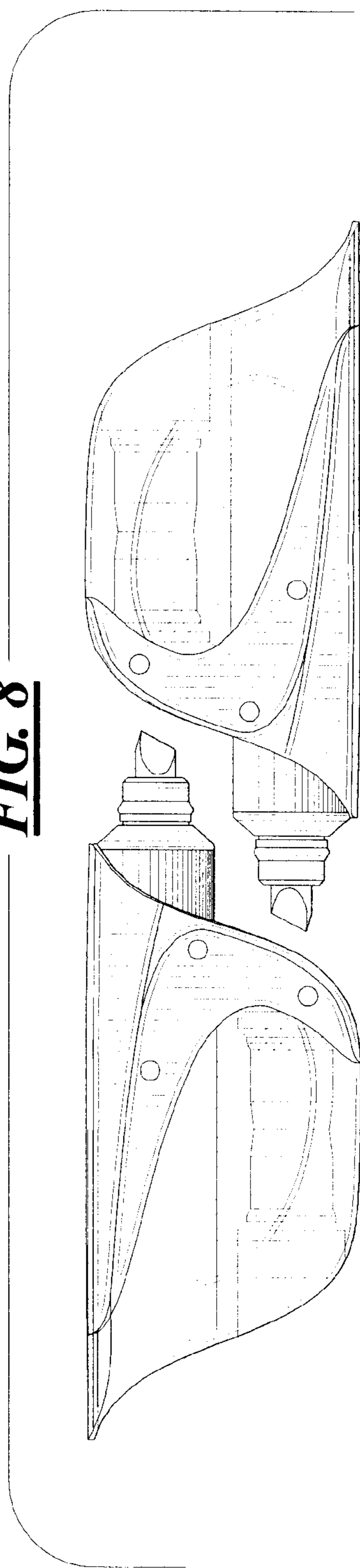
**FIG. 5**



**FIG. 6**

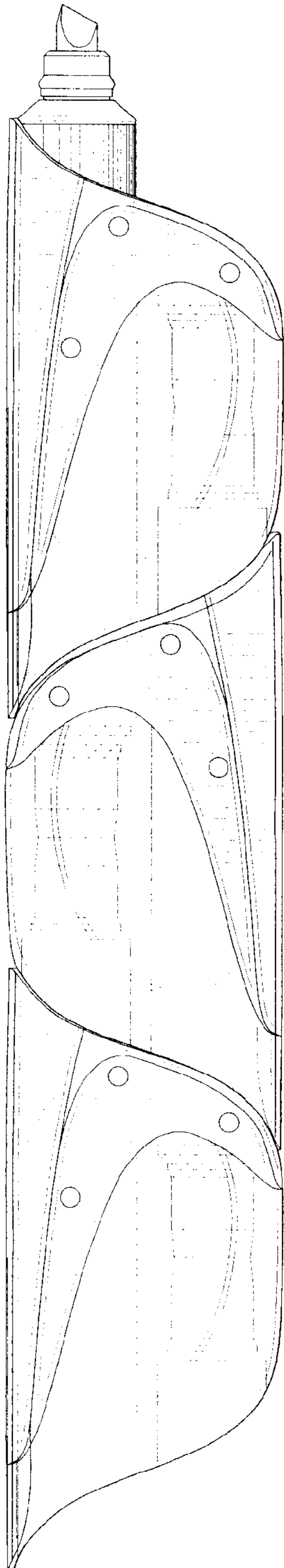


**FIG. 7**

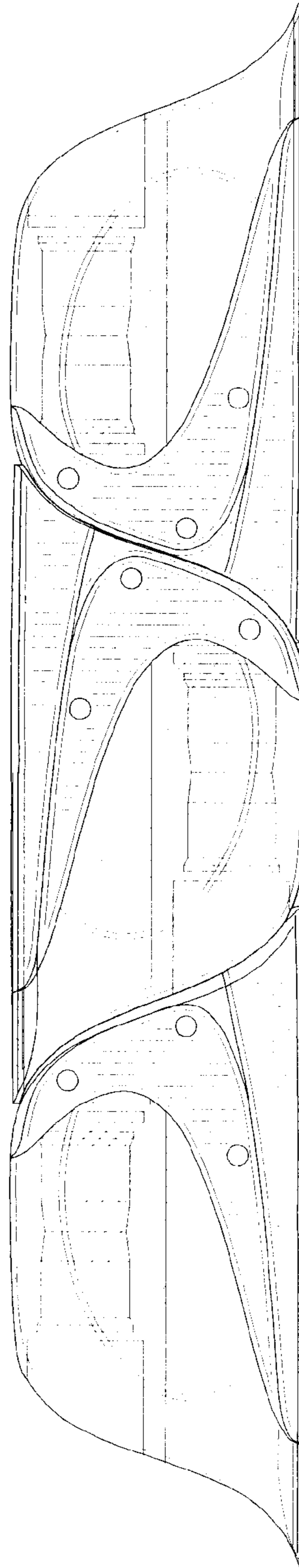


**FIG. 8**

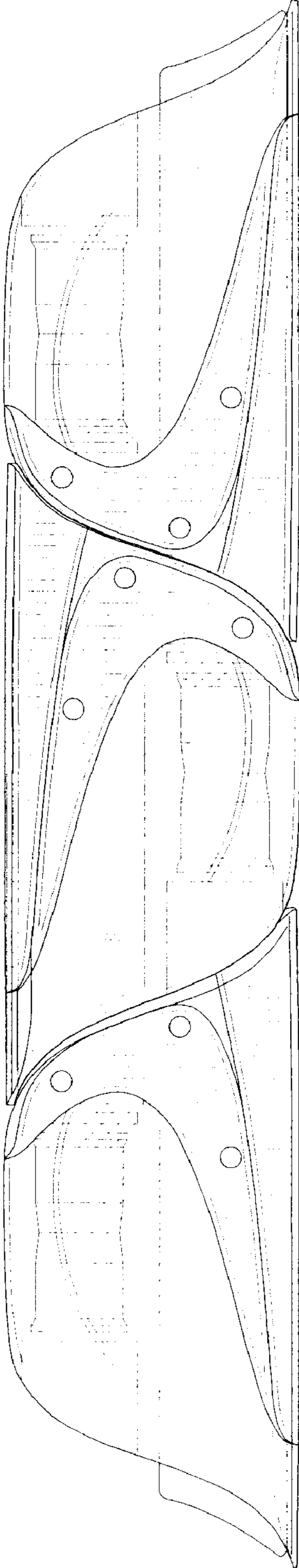
**FIG. 9**



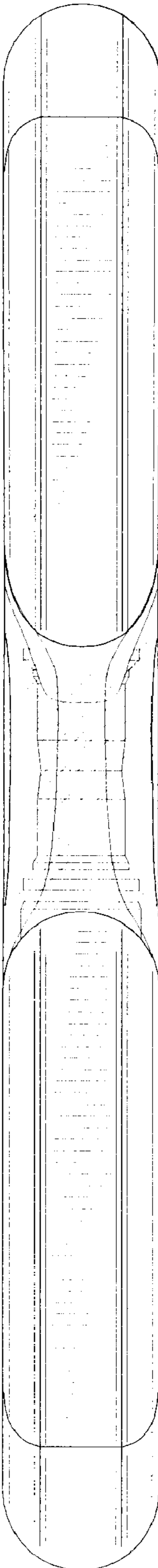
**FIG. 10**



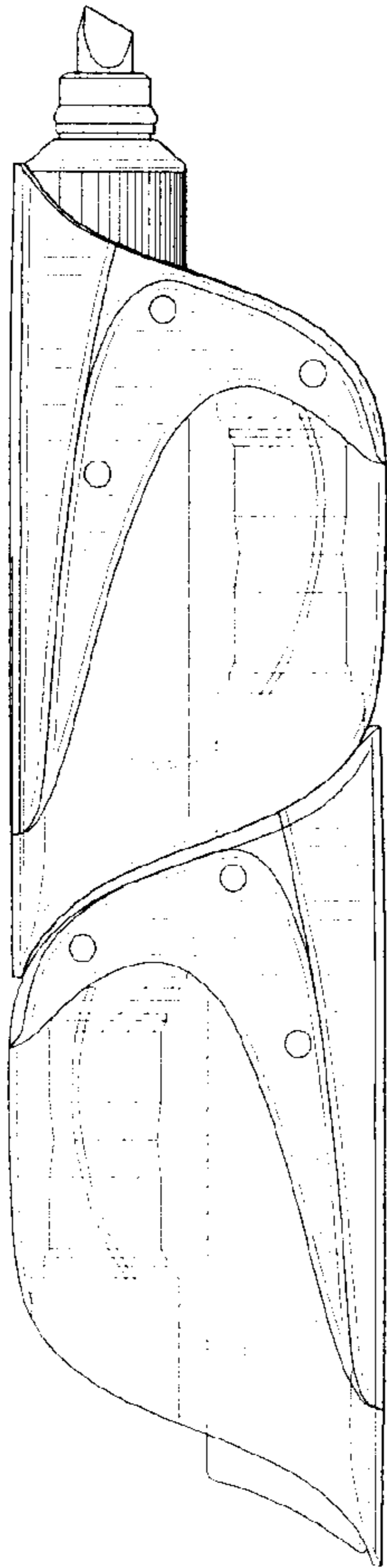
**FIG. 11**



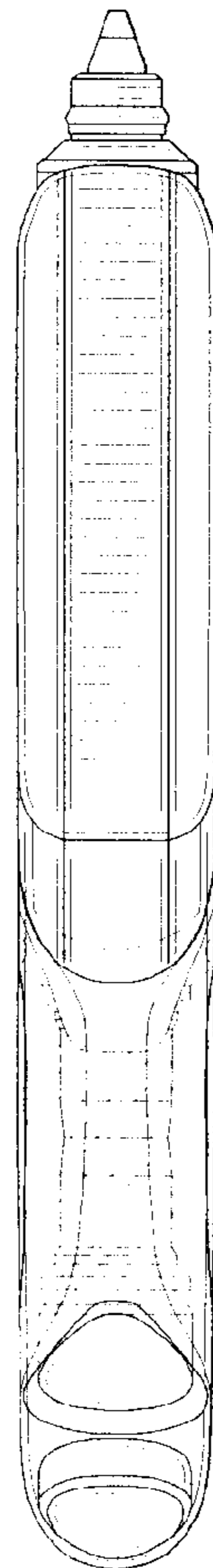
**FIG. 12**



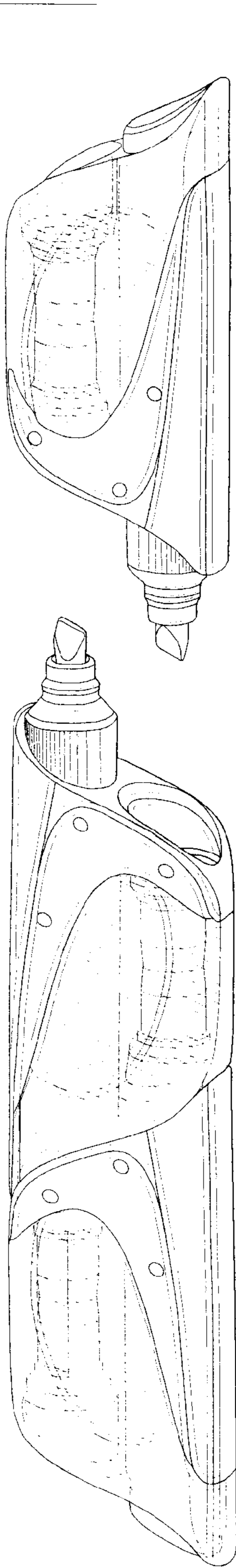
**FIG. 13**



**FIG. 14**



**FIG. 15**



**FIG. 16**

