

US00D504740S

(12) **United States Design Patent**
Dalton et al.

(10) **Patent No.:** **US D504,740 S**
(45) **Date of Patent:** **** May 3, 2005**

(54) **FLASHLIGHT**

D451,225 S * 11/2001 Chien D26/49
D497,020 S * 10/2004 Lee D26/49

(75) Inventors: **David R. Dalton**, Turramurra (AU);
John R. Brown, Mosman (AU);
Joseph P. Gardner, North Ridgeville,
OH (US)

* cited by examiner

Primary Examiner—Marcus A. Jackson
(74) *Attorney, Agent, or Firm*—Stewart A. Fraser

(73) Assignee: **Eveready Battery Company, Inc.**, St.
Louis, MO (US)

(57) **CLAIM**

(**) Term: **14 Years**

We claim the ornamental design for a flashlight, as shown
and described.

(21) Appl. No.: **29/207,073**

DESCRIPTION

(22) Filed: **Jun. 8, 2004**

FIG. 1 is an upper front perspective view of the flashlight of
the present invention;

(30) **Foreign Application Priority Data**

Dec. 9, 2003 (AU) 4374/2003

FIG. 2 is a plan view of the flashlight of the present
invention;

(51) **LOC (7) Cl.** **26-02**

FIG. 3 is an underneath view of the flashlight of the present
invention;

(52) **U.S. Cl.** **D26/49**

FIG. 4 is a right side view of the flashlight of the present
invention;

(58) **Field of Search** D26/37-50; 362/157,
362/158, 171-174, 183-208

FIG. 5 is a left side view of the flashlight of the present
invention;

(56) **References Cited**

FIG. 6 is a front view of the flashlight of the present
invention; and,

U.S. PATENT DOCUMENTS

FIG. 7 is a rear view of the flashlight of the present
invention.

D445,934 S * 7/2001 Dalton et al. D26/49
D449,703 S * 10/2001 Dalton et al. D26/49

1 Claim, 7 Drawing Sheets

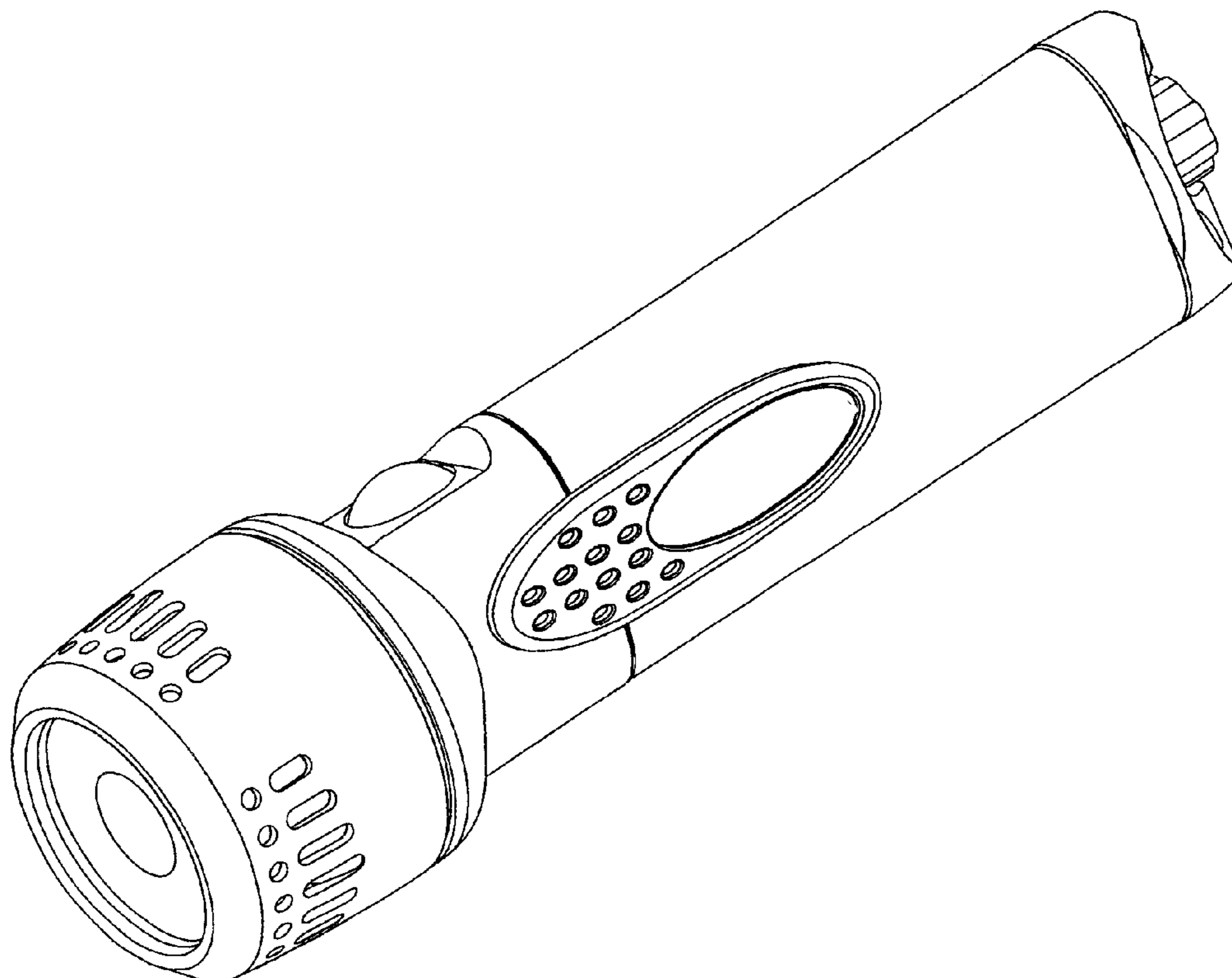

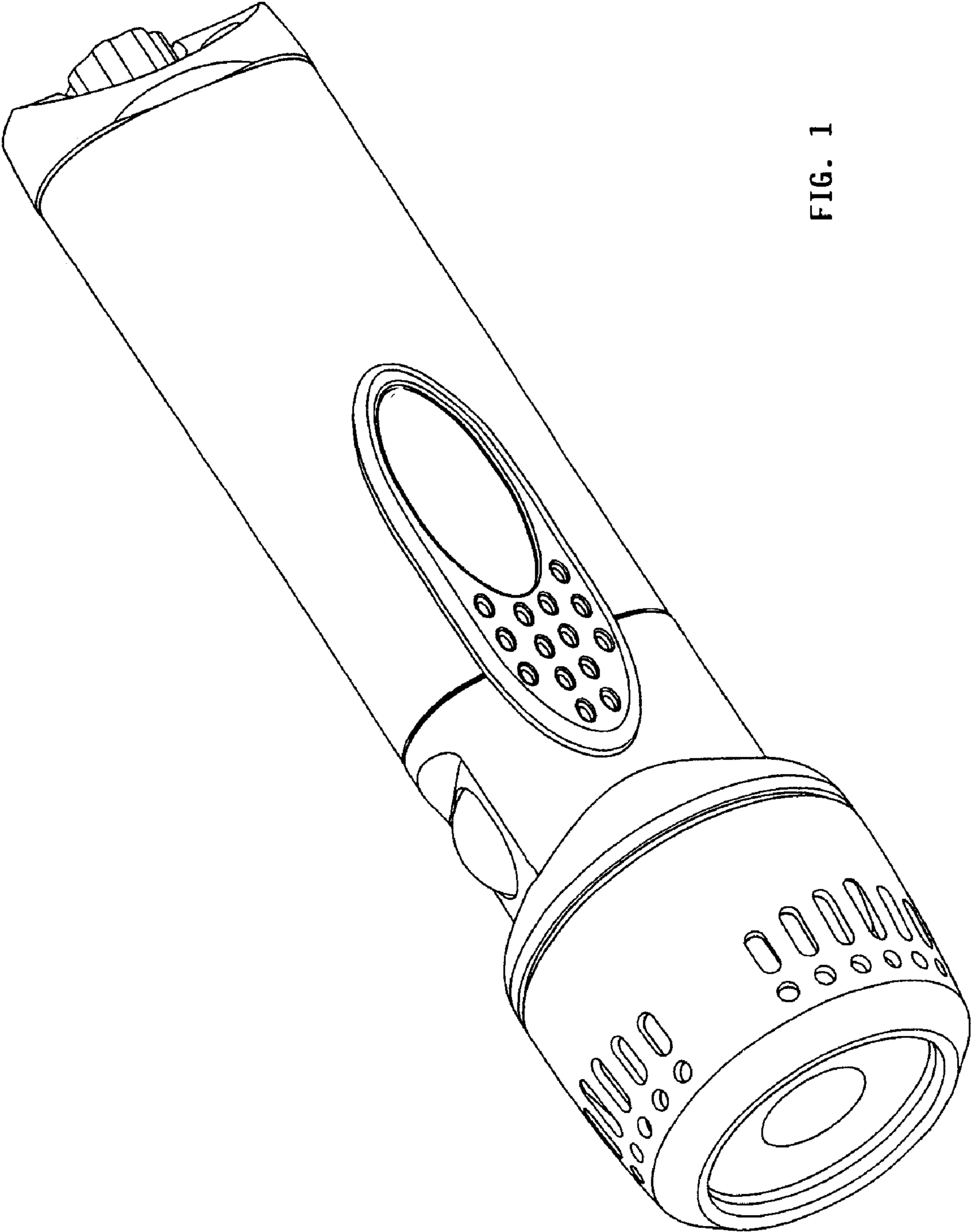

FIG. 1

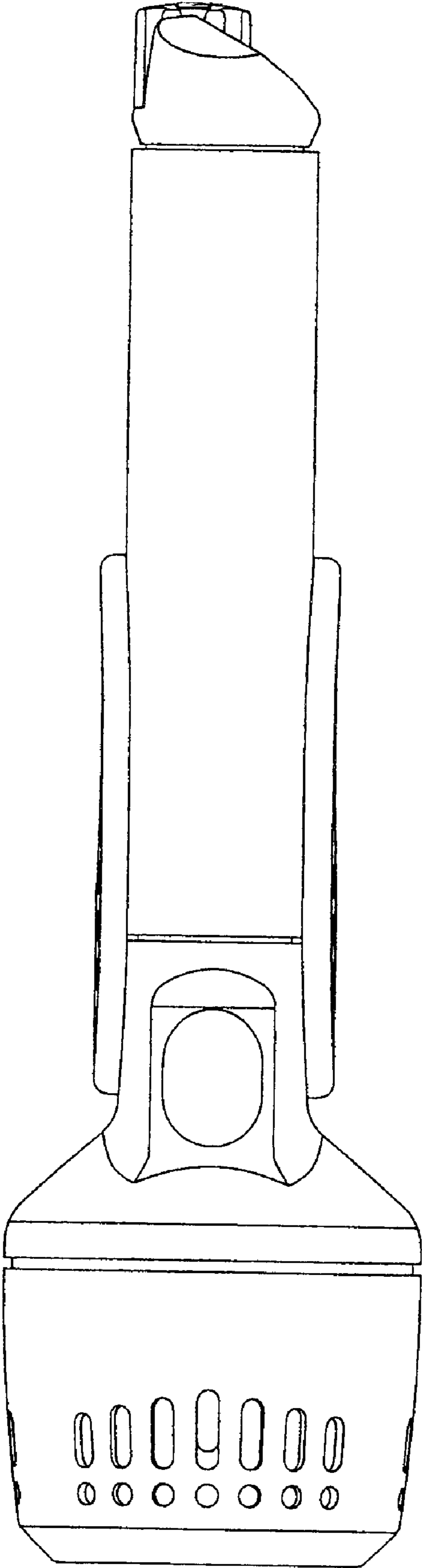

FIG. 2

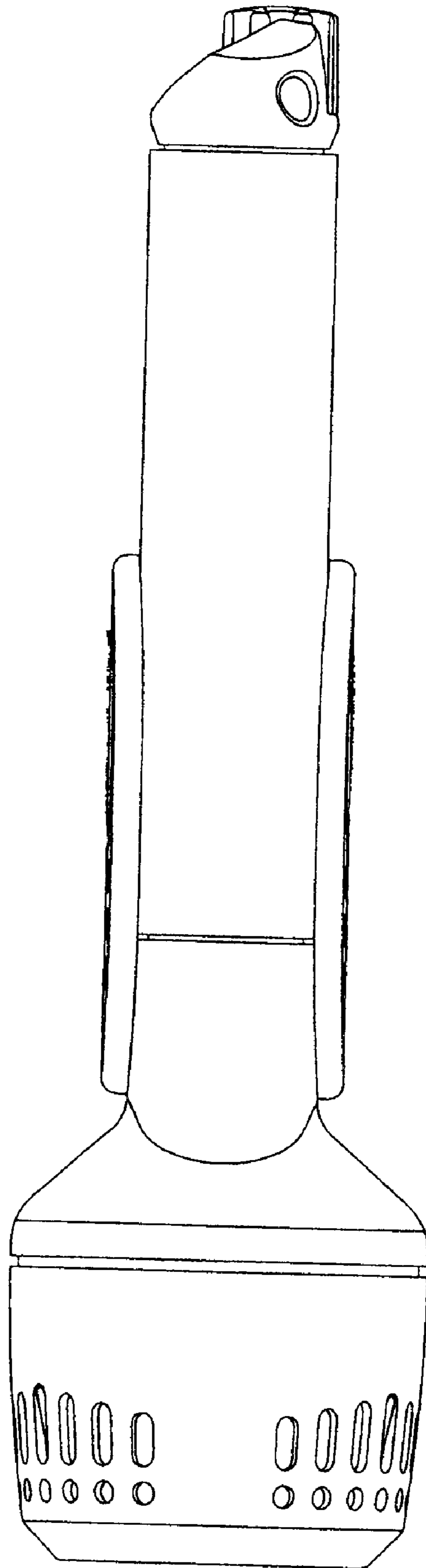

FIG. 3

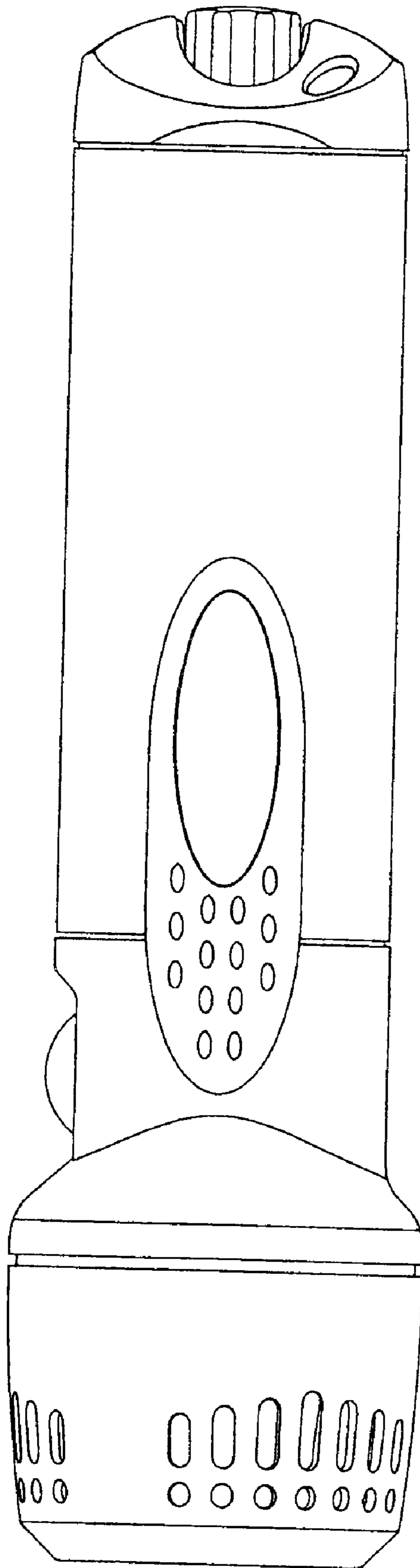

FIG. 4

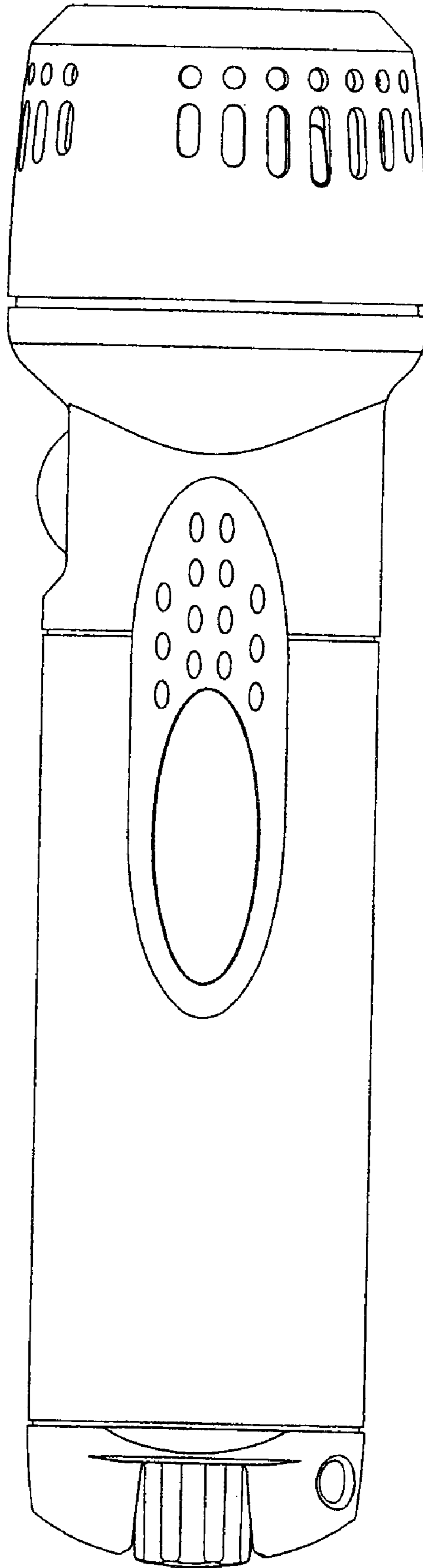

FIG. 5

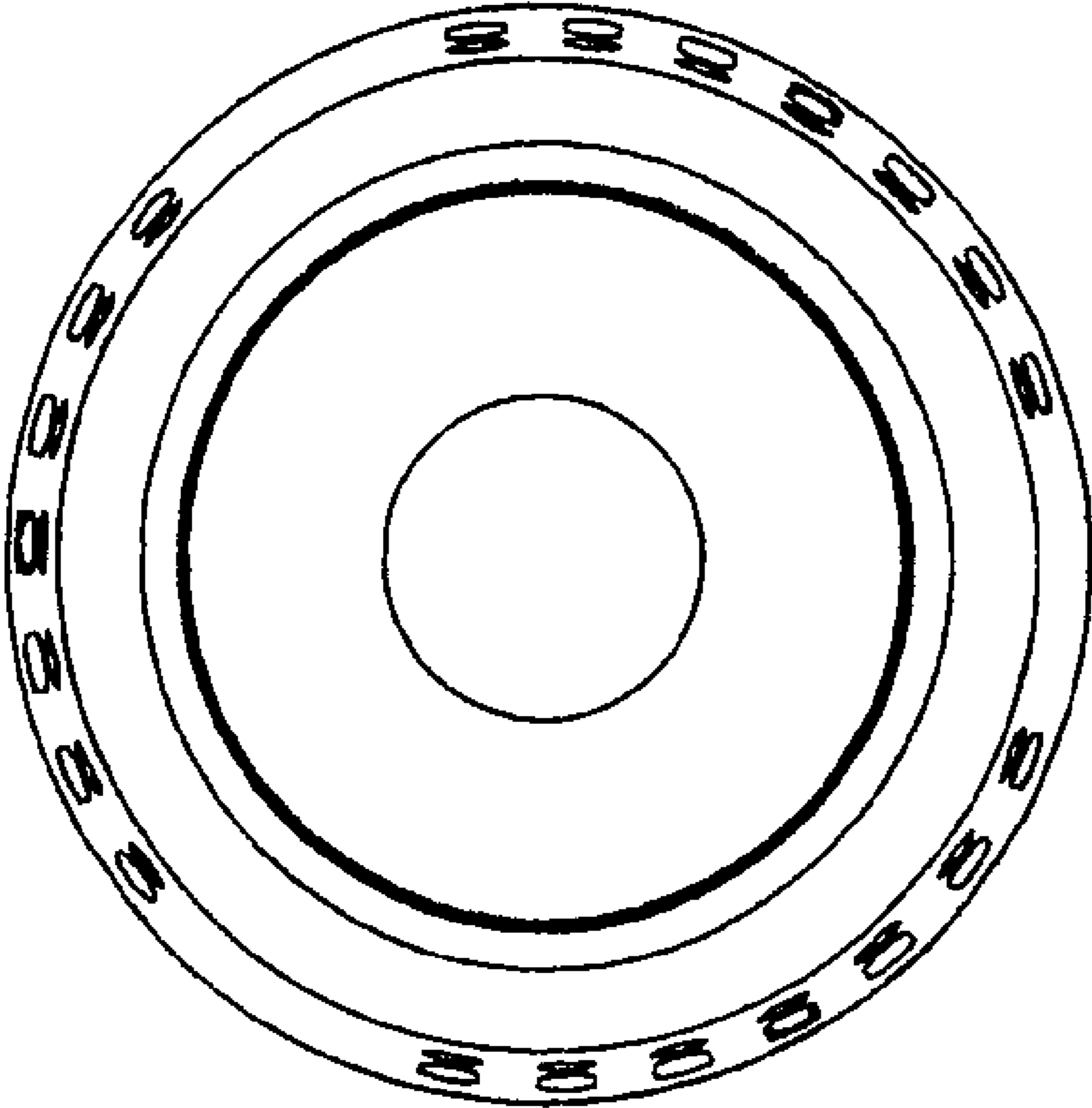

FIG. 6

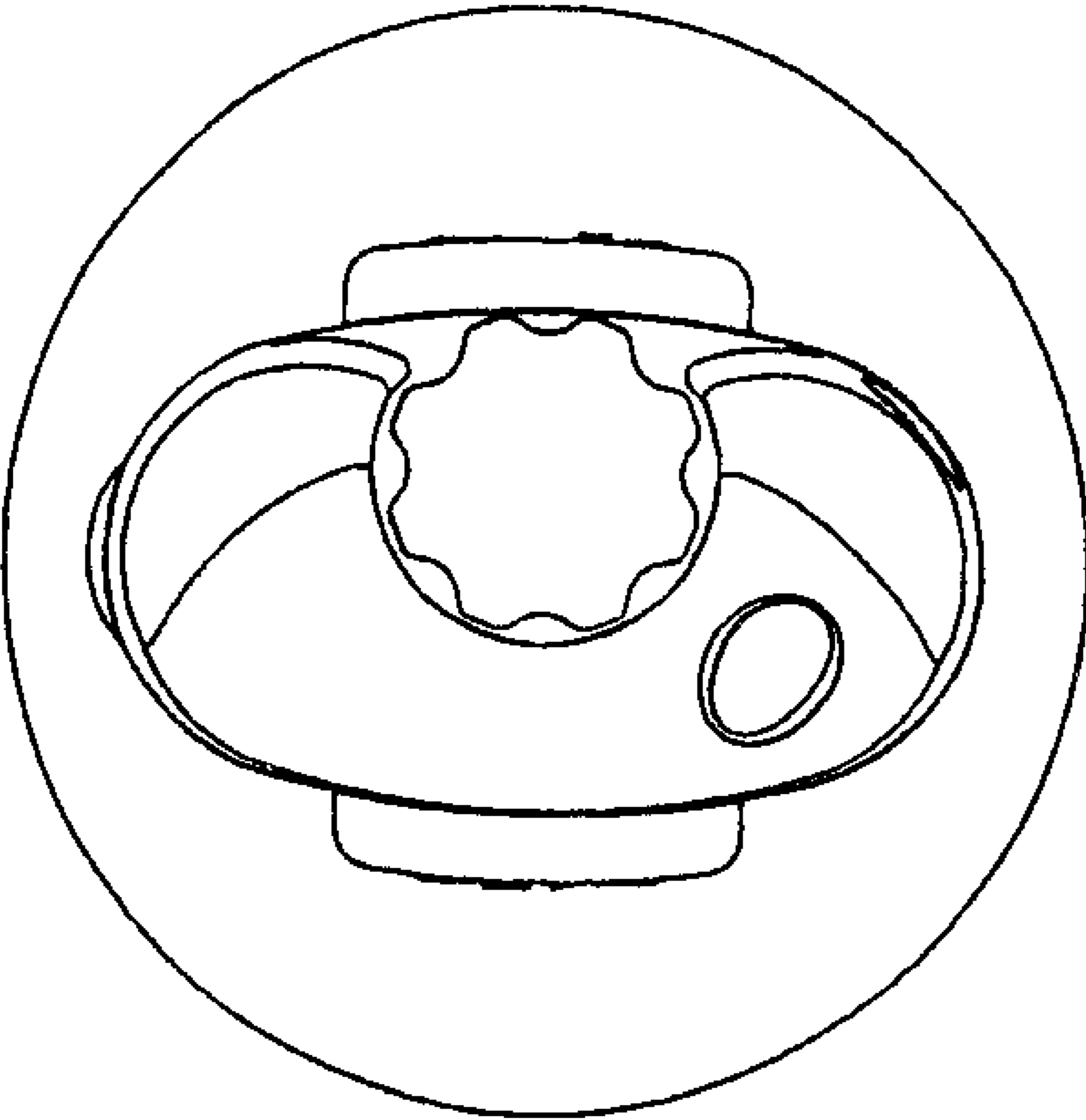

FIG. 7