



US00D504580S

(12) **United States Design Patent**
Kreiss

(10) **Patent No.:** **US D504,580 S**
(45) **Date of Patent:** **** May 3, 2005**

(54) **CHAIR**

D478,430 S * 8/2003 Olson D6/380

(75) Inventor: **Michael Kreiss**, San Diego, CA (US)

* cited by examiner

(73) Assignee: **Kreiss Enterprises**, San Diego, CA (US)

Primary Examiner—Mimosa De
(74) *Attorney, Agent, or Firm*—Marvin H. Kleinberg; Marshal A. Lerner; Kleinberg & Lerner, LLP

(**) Term: **14 Years**

(57) **CLAIM**

(21) Appl. No.: **29/179,554**

The ornamental design for a chair, as shown and described.

(22) Filed: **Apr. 10, 2003**

DESCRIPTION

(51) **LOC (7) Cl.** **06-01**

FIG. 1 is a perspective view of the chair of the present invention;

(52) **U.S. Cl.** **D6/380**

FIG. 2 is a front elevational view of the chair of FIG. 1;

(58) **Field of Search** D6/334, 335, 369, D6/374, 376, 379, 380, 500-502; 297/445.1, 446.1, 452.63

FIG. 3 is a side elevational view of the chair of FIG. 1 the opposite side being a mirror image thereof;

FIG. 4 is a top view of the chair of FIG. 1;

FIG. 5 is a bottom view of the chair of FIG. 1; and,

FIG. 6 is a rear elevational view of the chair of FIG. 1.

The chair of the present invention is symmetrical about a longitudinal axis.

(56) **References Cited**

U.S. PATENT DOCUMENTS

D334,296 S * 3/1993 Hutton D6/374
D395,758 S * 7/1998 Hutton D6/334

1 Claim, 6 Drawing Sheets

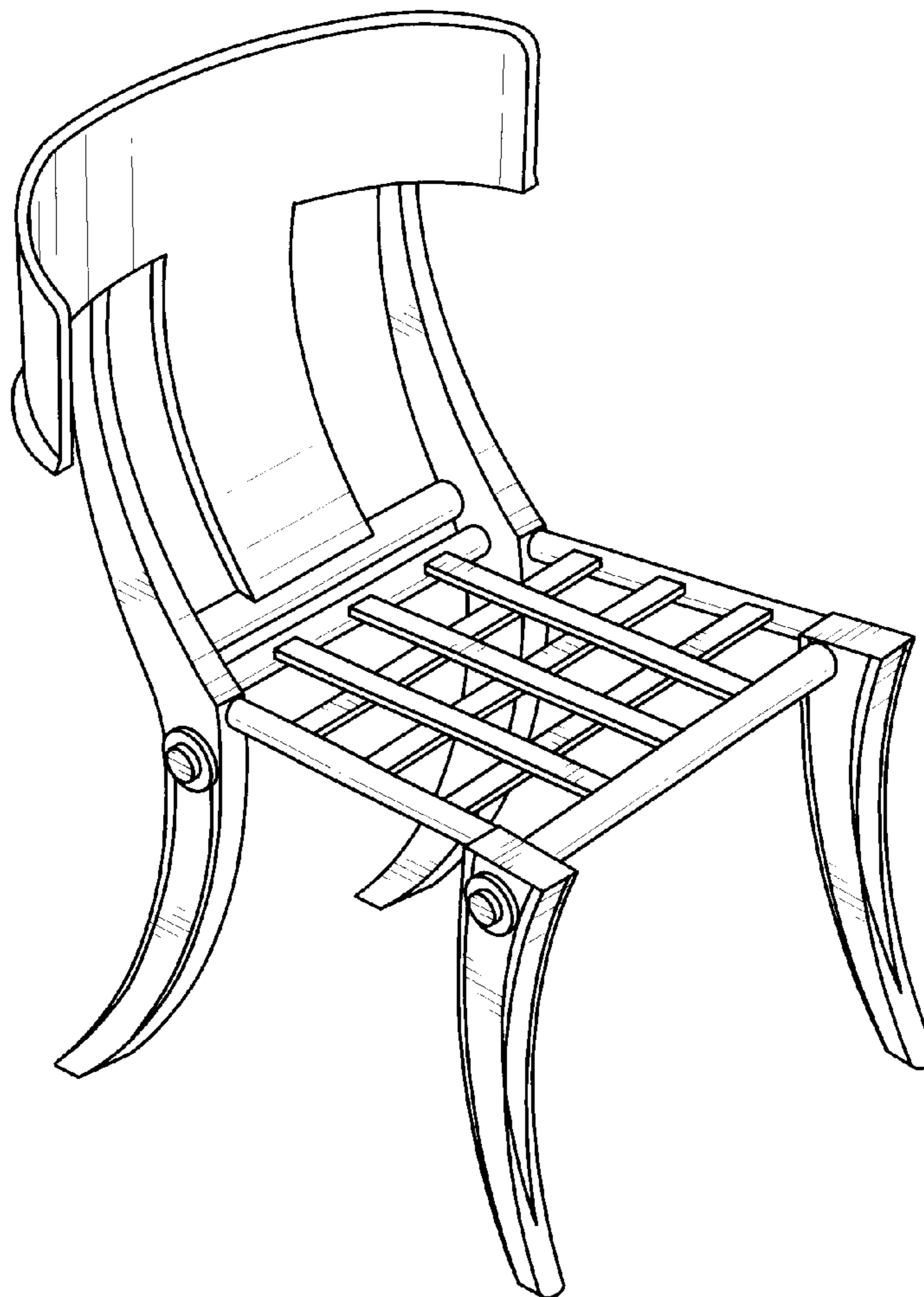

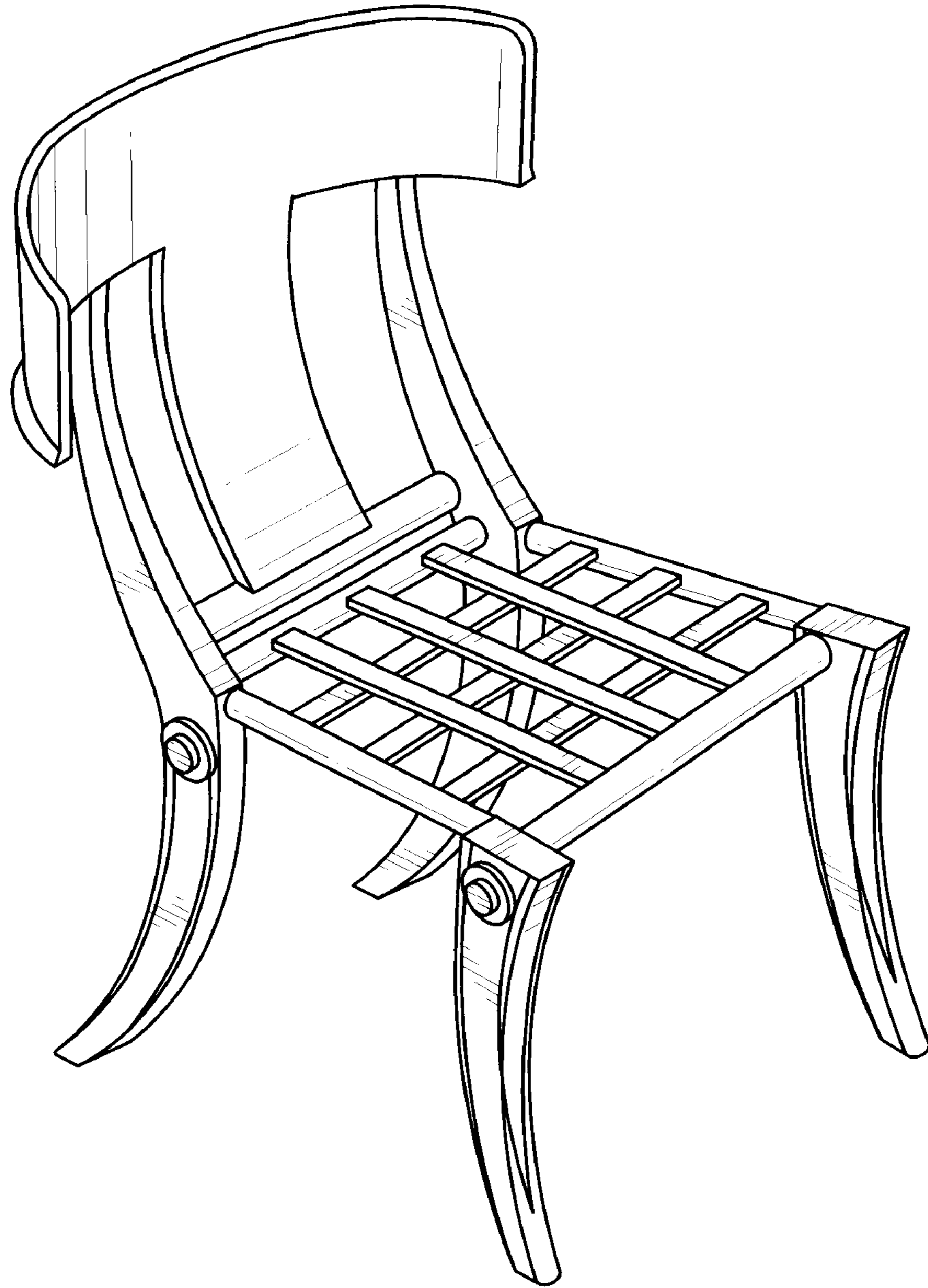

FIG. 1

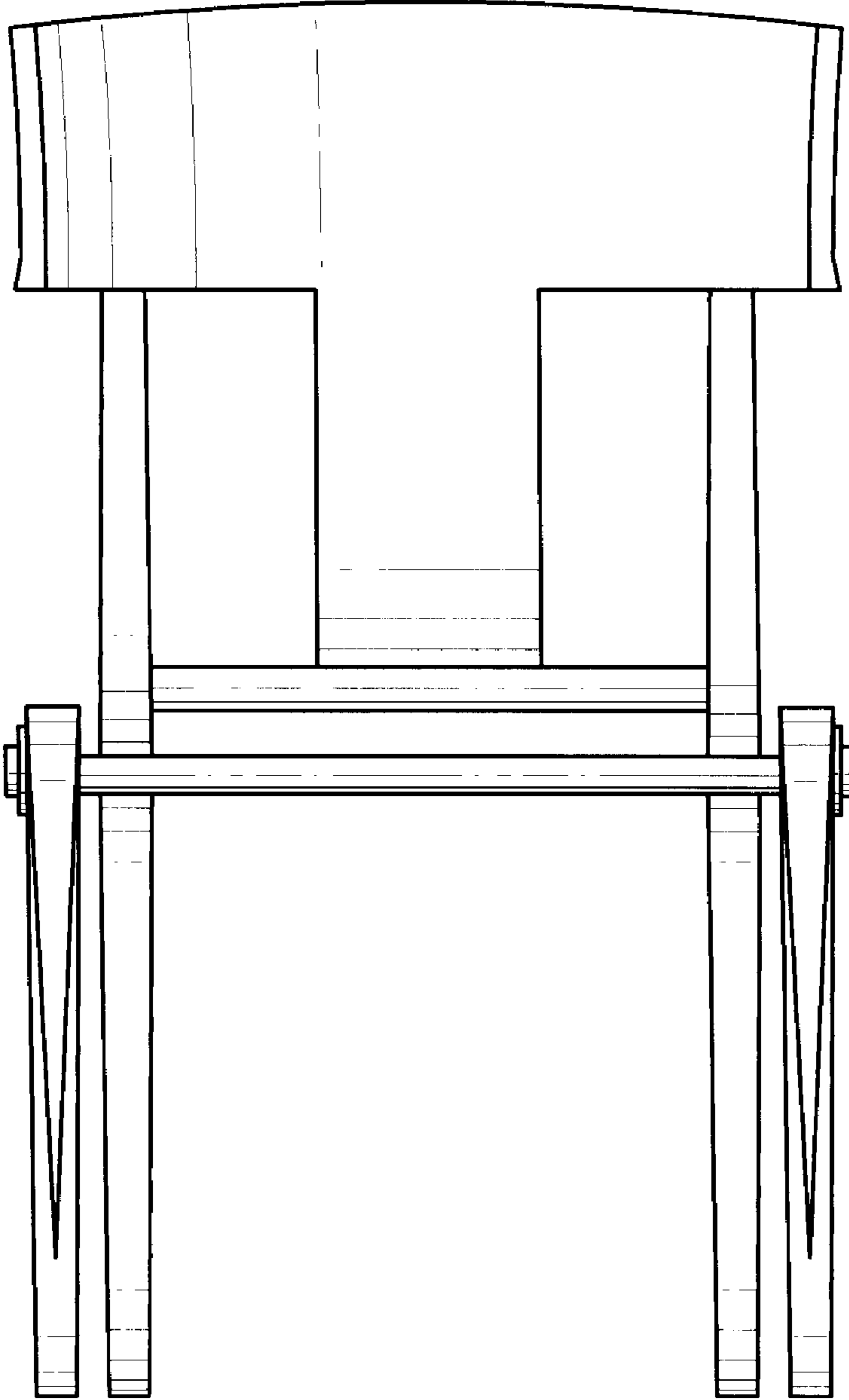

FIG. 2

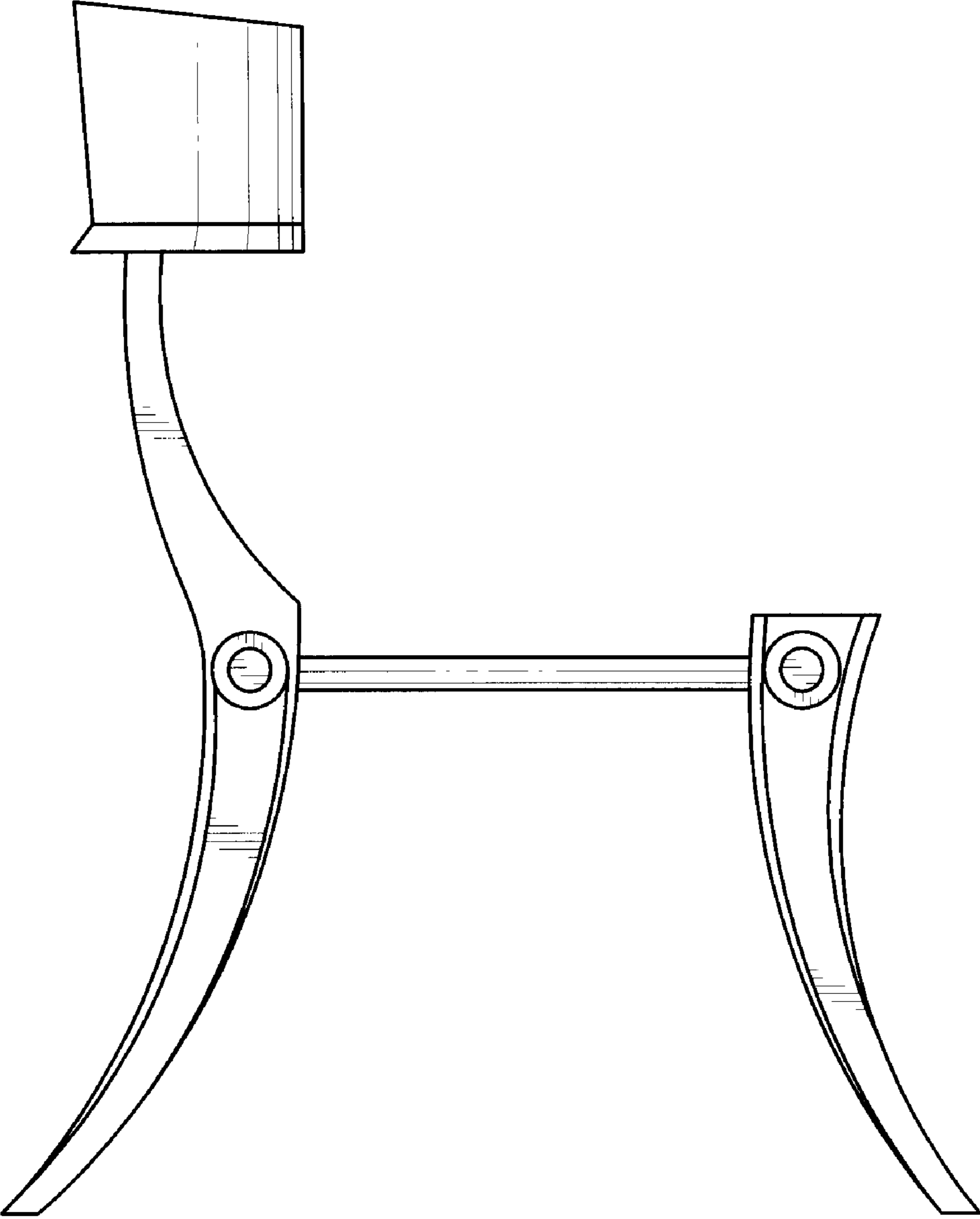

FIG. 3

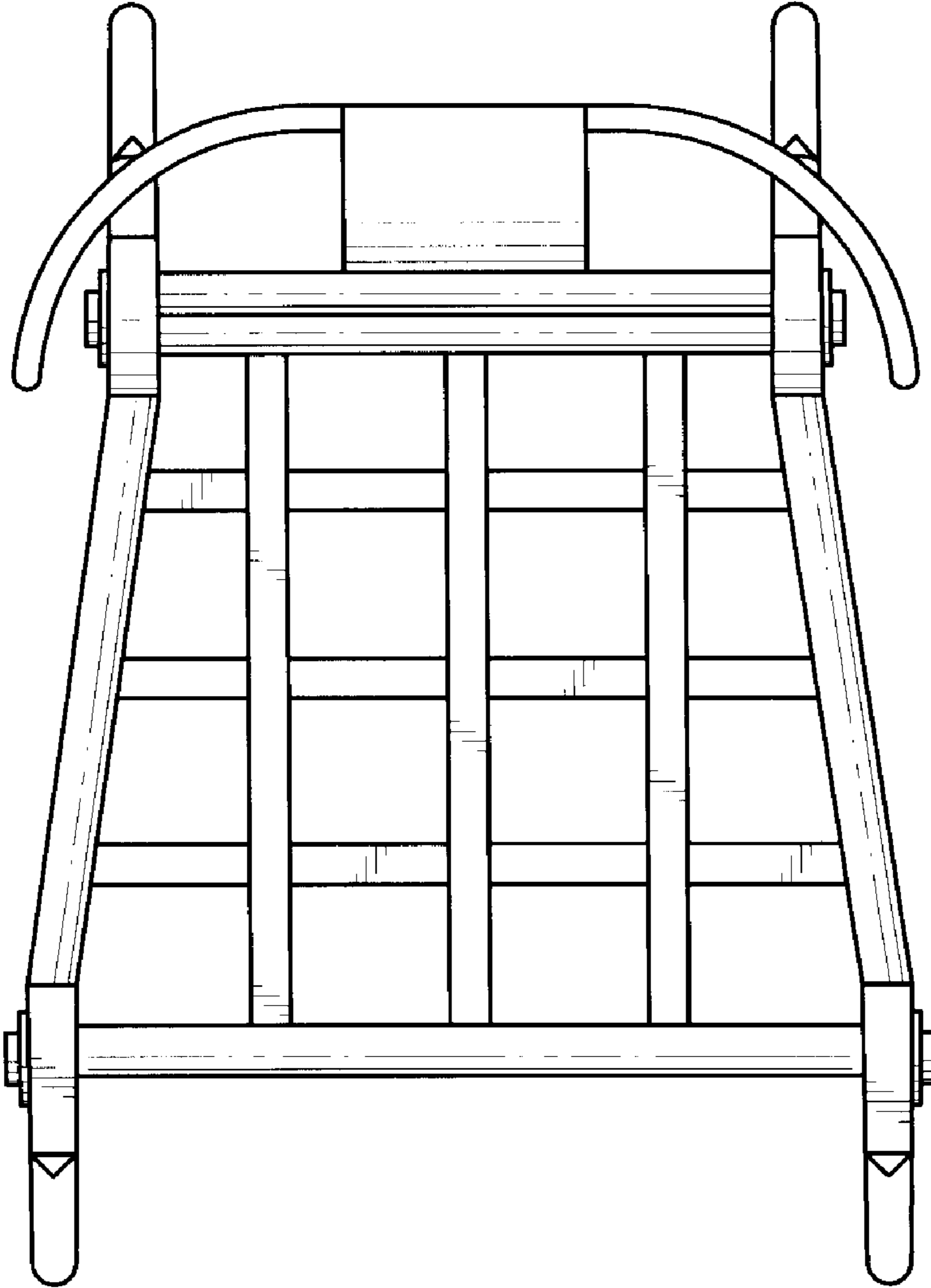

FIG. 4

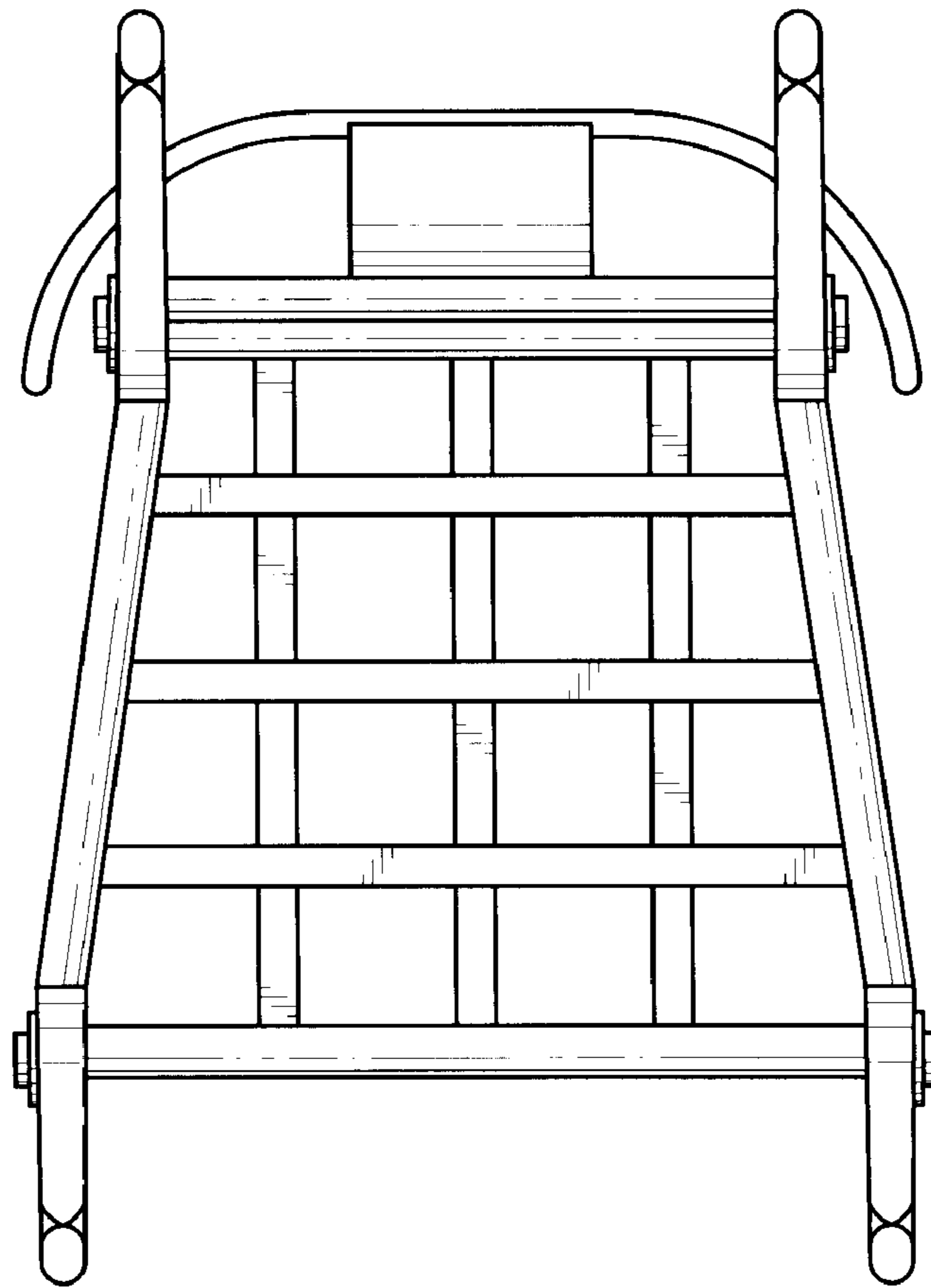

FIG. 5

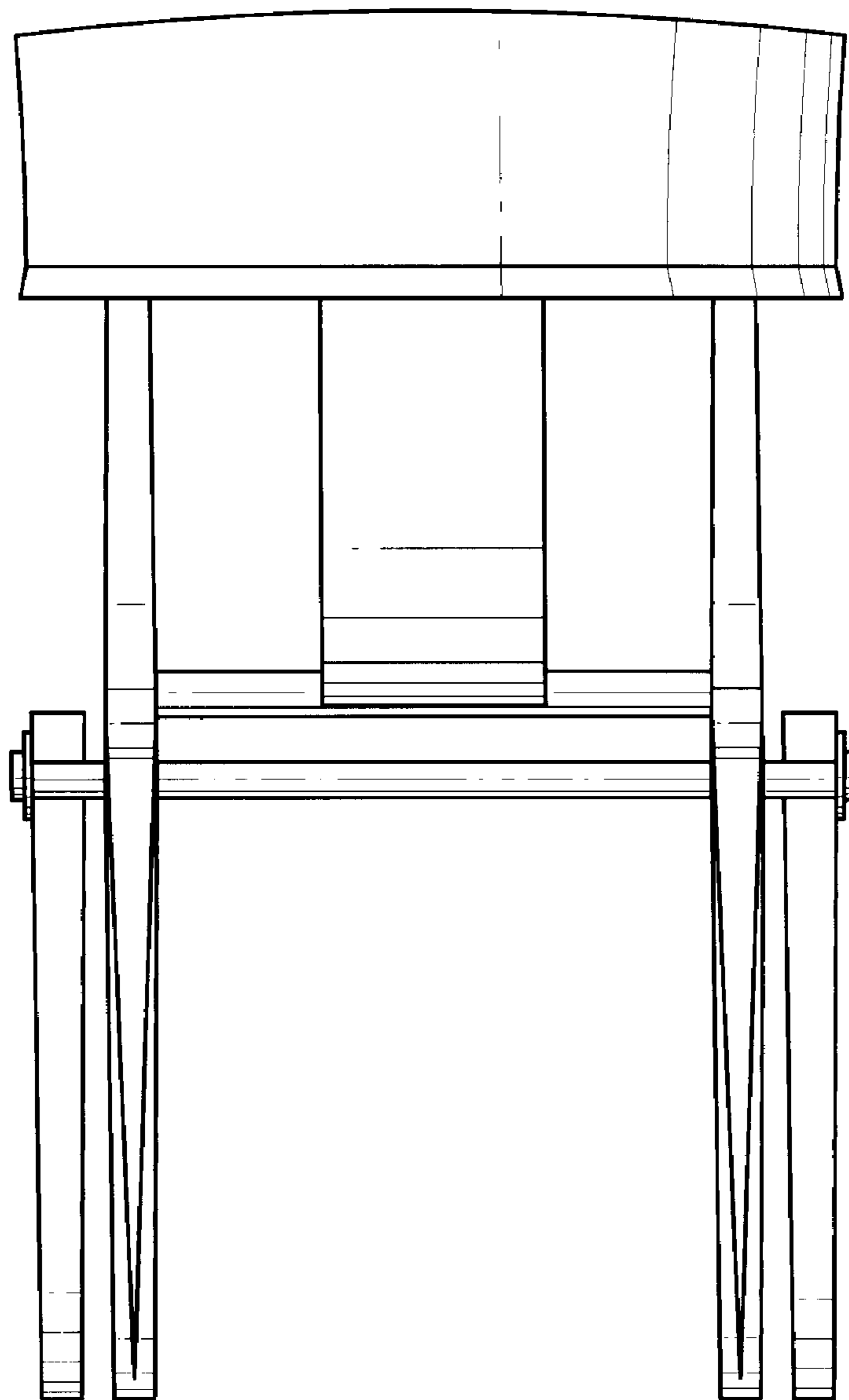

FIG. 6